



ADAPTOR CATALOGUE



2024

www.ayrtecfittings.com

Ayrtec

About Us:-

At AYRTEC, we make your supply simple. We manufacture high-quality product in China, delivering directly to you in an efficient and professional way - all at a competitive price.

We take care of *everything*, removing the pain of the process for you, helping you gain your competitive edge.

AYRTEC, We Are:-

- *Innovative* - we maximise efficiency to benefit our customers
- *Supportive* - we take care of everything so you don't have to
- *Experienced* - we have over 30 years experience in this business
- *Respected* - we help take your business to another level
- *Driven* - our customers are at the heart of what we do
- *Committed* - we strive to improve what we do everyday
- *Optimistic* - we see opportunities in problems. Always
- Lastly, we *Listen*. It's how we learn and improve

Our Products:-

- Hydraulic Adaptors
- Hose Fittings
- Quick Release Couplings
- Ball Valves
- Tube Clamps
- Accessories



CATALOGUE LAYOUT

There is a lot of content. The catalogue is organised to help you find what you need quickly.

Visual Index:-

A pictorial guide set out by adaptor types.

18 pages of visual guide. Find the item you Require and go straight to the referenced page.

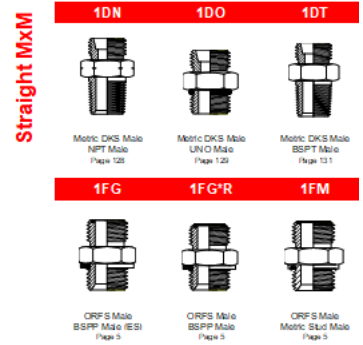

Main Catalogue:-

Over 140 pages of Fitting Detail.

1B

BSPP Male x BSPP Male

For use with dowty seals

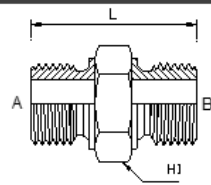

Item No	A-BSPP	B-BSPP	L	H1
1B-0202	-02 1/8-28	-02 1/8-28	23	14
1B-0402	-04 1/4-19	-02 1/8-28	30	19
1B-0404	-04 1/4-19	-04 1/4-19	32	19
1B-0604	-06 3/8-19	-04 1/4-19	34	22
1B-0606	-06 3/8-19	-06 3/8-19	34	22
1B-0804	-08 1/2-14	-04 1/4-19	38	27
1B-0806	-08 1/2-14	-06 3/8-19	38	27
1B-0808	-08 1/2-14	-08 1/2-14	40	27
.....

Explanation of Part Number System:-

A guide on the basics of how the Part Numbers are constructed.

Part Number Examples

Two common part numbers are broken down into their components in the examples below.



Index by Part Number:-

Included Part Descriptions, which Visual Index section and Main Catalogue page number

AYRTEC Item No	Short Description	Catalogue Page No	Visual Index Section
1B	BSPP Male x BSPP Male	1	Straight MxM
1BFL	BSPP Male x SAE Cd 61 Flange	3	Straight MxM
1BFLH	BSPP Male x SAE Cd 62 Flange	3	Straight MxM
1BG9	BSPP Male x BSPP Male 90 Degree	74	90 Degree
1BM	BSPP Male x Metric Stud Male	2	Straight MxM
1BO	BSPP Male x UNO Male	3	Straight MxM

VISUAL INDEX

Straight MxM

1B	1BM	1BO	1C	1CG	1CM
BSPP Male BSPP Male Page 1	BSPP Male Metric Stud Male Page 2	BSPP Male UNO Male Page 3	Metric DKL Male Metric DKL Male Page 121	Metric DKL Male BSPP Male Page 123	Metric DKL Male Metric Stud Male Page 126
1CN	1CO	1CT	1D	1DG	1DM
Metric DKL Male NPT Male Page 127	Metric DKL Male UNO Male Page 129	Metric DKL Male BSPT Male Page 131	Metric DKS Male Metric DKS Male Page 122	Metric DKS Male BSPP Male Page 124	Metric DKS Male Metric Stud Male Metric Male
1DN	1DO	1DT	1E	1ET	1F
Metric DKS Male NPT Male Page 128	Metric DKS Male UNO Male Page 129	Metric DKS Male BSPT Male Page 131	Metric Flat Face Metric Flat Face Page 4	Metric Flat Face BSPT Male Page 4	ORFS Male ORFS Male Page 4
1FG	1FG*R	1FM	1FN	1FO	1FT
ORFS Male BSPP Male (ES) Page 5	ORFS Male BSPP Male Page 5	ORFS Male Metric Stud Male Page 5	ORFS Male NPT Male Page 6	ORFS Male UNO Male Page 6	ORFS Male BSPT Male Page 7
1G	1G*R	1J	1JC	1JD	1JE
BSPP Male (ES) BSPP Male (ES) Page 1	BSPP Male BSPP Male Page 2	JIC Male JIC Male Page 7	JIC Male Metric DKL Male Page 133	JIC Male Metric DKS Male Page 133	JIC Male Metric Flat Face Page 8

Straight MxM

1JF

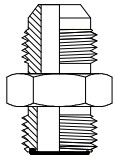

JIC Male
ORFS Male
Page 8

1JG

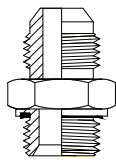

JIC Male
BSPP Male
Page 10

1JI

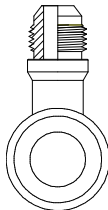

JIC Male
Banjo
Page 12

1JM

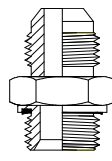

JIC Male
Metric Stud Male
Page 12

1JN

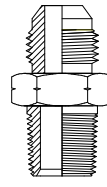

JIC Male
NPT Male
Page 13

1JO

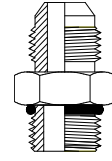

JIC Male
UNO Male
Page 14

1JOL

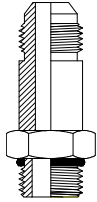

JIC Male
UNO Male
Page 15

1JPI

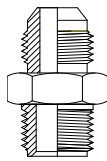

JIC Male
SAE Inverted Flare
Page 15

1JT

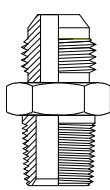

JIC Male
BSPT Male
Page 15

1K

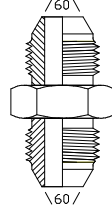

JIS Komatsu Male
JIS Komatsu Male
Page 16

1KT

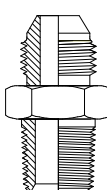

JIS Komatsu Male
BSPT Male
Page 16

1N

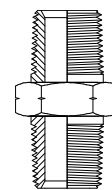

NPT Male
NPT Male
Page 16

1NB

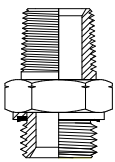

NPT Male
BSPP Male
Page 17

1NO

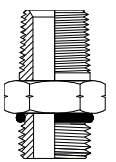

NPT Male
UNO Male
Page 17

1O

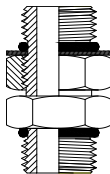

UNO Male
UNO Male
Page 17

1P

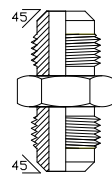

SAE Male
SAE Male
Page 18

1PPI

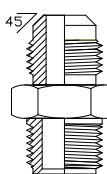

SAE Male
SAE Inv. Flare Male
Page 18

1PT

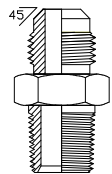

SAE Male
BSPT Male
Page 18

1S

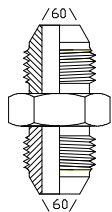

JIS (BSP) Male
JIS (BSP) Male
Page 19

1ST

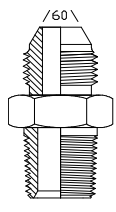

JIS (BSP) Male
BSPT Male
Page 19

1T

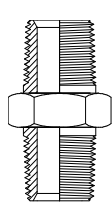

BSPT Male
BSPT Male
Page 19

1TG

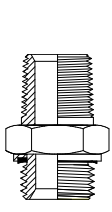

BSPT Male
BSPP Male
Page 20

1TM

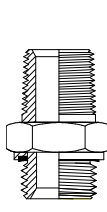

BSPT Male
Metric Stud Male
Page 21

1TN

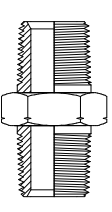

BSPT Male
NPT Male
Page 22

1TO

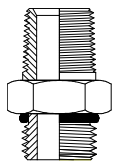

BSPT Male
UNO Male
Page 22

GE

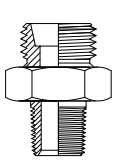

Metric DKL
Metric Taper Male
Page 141

Straight MxFS

2C	2D	2F	2F1	2F2	2F200
Metric DKL Metric DKL Page 134	Metric DKS Metric DKS Page 135	ORFS Male ORFS Female Page 24	ORFS Male ORFS Fixed Female Page 24	ORFS Female ORFS Male Page 24	ORFS Tube Nut Page 24
2FJ	2GB	2GC	2GD	2GF	2GJ
ORFS Male ORFS Female Page 25	BSPP Male BSPP Female Page 25	BSPP Male Metric DKL Female Page 136	BSPP Male Metric DKS Female Page 136	BSPP Male ORFS Female Page 26	BSPP Male JIC Female Page 27
2J	2J1	2J2	2J200	2J300	2JB
JIC Male JIC Female Page 30	JIC Male JIC Fixed Female Page 29	JIC Male JIC Female Page 30	JIC Tube Nut Page 31	JIC Tube Sleeve Page 31	JIC Male BSP Female Page 31
2JF	2JTNS	2MC	2NJ	2NU	2OB
JIC Male ORFS Female Page 32	JIC Tube Nut + Sleeve Page 31	Metric Male Metric DKL Female Page 137	NPT Male JIC Female Page 32	NPT Male NPSM Female Swivel Page 33	UNO Male BSPP Female Page 33
2OU	2OF	2OJ	2TB	2TF	2TJ
UNO Male NPSM Female Swivel Page 34	UNO Male ORFS Female Page 33	UNO Male JIC Female Page 34	BSPT Male BSPP Female Page 35	BSPT Male ORFS Female Page 35	BSPT Male JIC Female Page 36

2TKW

NL / NS

RL / RS

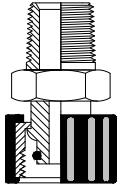

BSPT Male
Karcher Female
Page 36

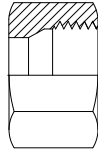

Metric Compression
DKL & DKS
Page 119



Metric Compression
DKL & DKS
Page 120

Straight FxF

3B 3C 3D 3F 3J 7B

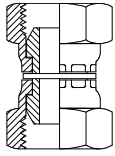

BSP Female
BSP Female
Page 37

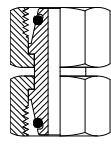

Metric DKL
Metric DKL
Page 137

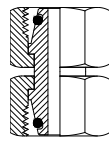

Metric DKS
Metric DKS
Page 138

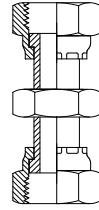

ORFS Female
ORFS Female
Page 37

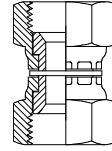

JIC Female
JIC Female
Page 37

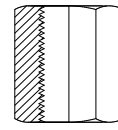

BSPP Female
BSPP Female
Page 38

7N 7NJ 7NU 7O 7T 7TB

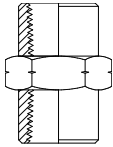

NPT Female
NPT Female
Page 38

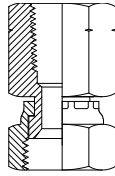

NPT Female
JIC Female
Page 38

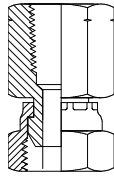

NPT Female
NPSM Female Swivel
Page 39

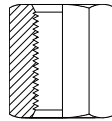

UNO Female
UNO Female
Page 39

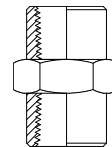

BSPT Female
BSPT Female
Page 40

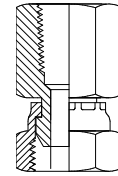

BSPT Female
BSP Female
Page 40

Straight MxFF

5CB 5DB 5FO 5G 5JN 5JT

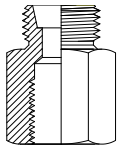

DKL Male
BSPP Female
Page 138

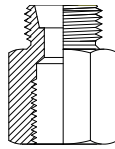

DKS Male
BSPP Female
Page 139

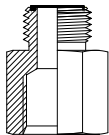

ORFS Male
UNO Female
#N/A

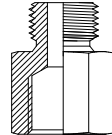

BSPP Male
BSPP Female
Page 41

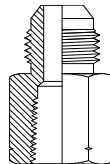

JIC Male
NPT Female
Page 41

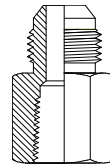

JIC Male
BSPT Female
Page 41

5N 5NO 5O 5ON 5OT 5T

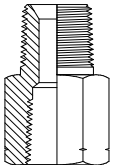

NPT Male
NPT Female
Page 42

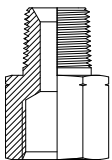

NPT Male
UNO Female
Page 42

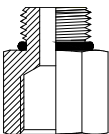

UNO Male
UNO Female
Page 43

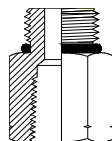

UNO Male
NPT Female
Page 43

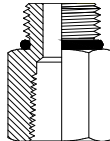

UNO Male
BSPT Female
Page 43

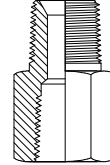

BSPT Male
BSPT Female
Page 44

5TN 5TO

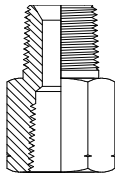

BSPT Male
NPT Female
Page 44

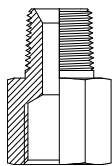

BSPT Male
UNO Female
Page 44

Straight Bulkhead

6C 6D 6F 6FG 6FO 6G

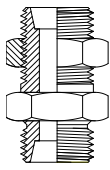

Metric DKL Bulkhead
Metric DKL Male
Page 139

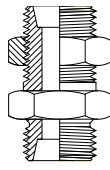

Metric DKS Bulkhead
Metric DKS Male
Page 139

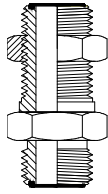

ORFS Bulkhead Male
ORFS Male
Page 45

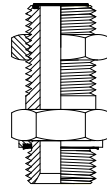

ORFS Bulkhead Male
BSPP Male
Page 45

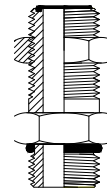

ORFS Bulkhead Male
UNO Male
Page 45

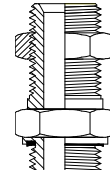

BSPP Bulkhead Male
BSPP Male
Page 45

6J 6JG 6JN 6JNF 6JT 6JTF

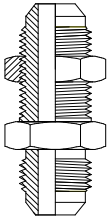

JIC Bulkhead Male
JIC Male
Page 46

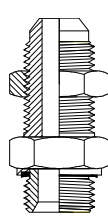

JIC Bulkhead Male
BSPP Male
Page 46

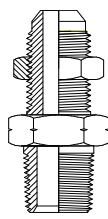

JIC Bulkhead Male
NPT Male
Page 46

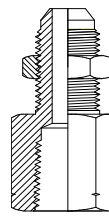

JIC Bulkhead Male
NPT Female
Page 46

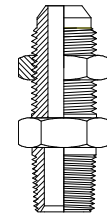

JIC Bulkhead Male
BSPT Male
Page 47

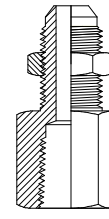

JIC Bulkhead Male
BSPT Fixed Female
Page 47

Plugs

4C 4D 4F 4FL 4FLH 4G

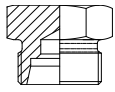

Metric DKL
Plug
Page 138

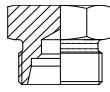

Metric DKS
Plug
Page 138

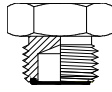

ORFS Male
Plug
Page 48

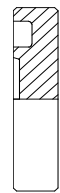

SAE Flange CD61
Plug
Page 48

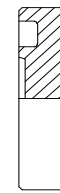

SAE Flange CD62
Plug
Page 48

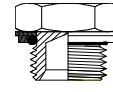

BSPP Male (ES)
Plug
Page 49

4J 4K 4M 4M*ES 4N 4O

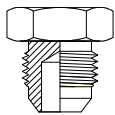

JIC Male
Plug
Page 50

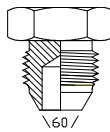

Plug
Page 50

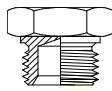

Metric
Plug
Page 51

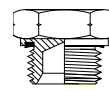

Metric
Plug
Page 50

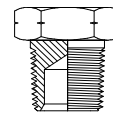

NPT Male
Plug
Page 52

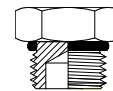

UNO Male
Plug
Page 52

4P 4Q 4S 4T

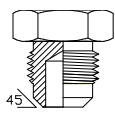

Plug
Page 53

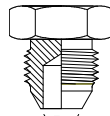

Metric 74 Degrees
Plug
Page 53

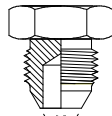

JIS (BSP) Male
Plug
Page 53

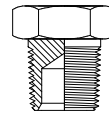

BSPT Male
Plug
Page 53

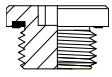
Plugs
4G-N

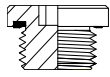
 BSPP Male
Hex Socket Plug
Page 49

4M-N

 Metric (encapsulated)
Hex Socket Plug
Page 51

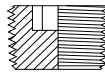
4M-N *O

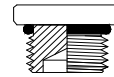
 Metric
Plug
Page 51

4N-N

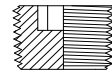
 NPT Male
Hex Socket Plug
Page 52

4O-N

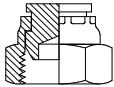
 UNO Male
Hex Socket Plug
Page 52

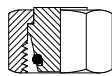
4T-N

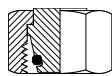
 BSPT Male
Hex Socket Plug
Page 54

Caps
9B

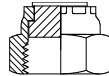
 BSPP
Cap
Page 54

9C

 Metric DKL
Cap
Page 141

9D

 Metric DKS
Cap
Page 141

9F

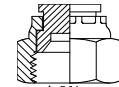
 ORFS
Cap
Page 54

9J*CAP

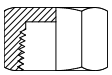
 JIC
Cap
Page 54

9K

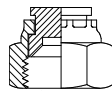
 JIS Komatsu
Cap
Page 55

9N

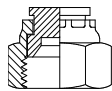
 NPT Female
Cap
Page 55

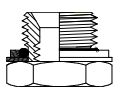
9P

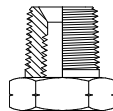
 SAE 45 Deg
Cap
Page 55

9S

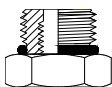
 JIS (BSP)
Cap
Page 55

Reducing Bush
4GR

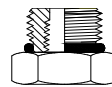
 BSPP - BSPP
Reducing Bush
Page 56

4NR

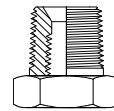
 NPT - NPT
Reducing Bush
Page 57

4OR

 UNO - UNO
Reducing Bush
Page 57

4OTR

 UNO - BSPT
Reducing Bush
Page 58

4TR

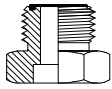
 BSPT - BSPT
Reducing Bush
Page 58

Tube Weld

4FW



ORFS Male
Tube Weld
Page 59

4GW

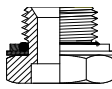

Tube Weld
Page 59

4JW

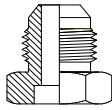

JIC Male
Tube Weld
Page 59

4TW

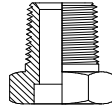

BSPT
Tube Weld
Page 60

9BW

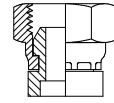

BSP Female
Tube Weld
Page 61

9FW

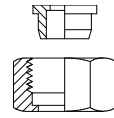

ORFS Female
Tube Weld
Page 61

9JW

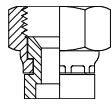

JIC Female
Tube Weld
Page 61

4JW9

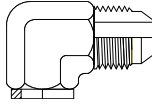

JIC Male
Tube Weld
Page 60

7OW

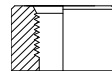

UNO Half Socket
Tube Weld
Page 60

45 Degree

1FG4

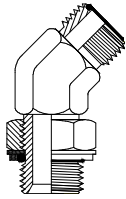

ORFS Male
BSPP Adj Male
Page 62

1FN4

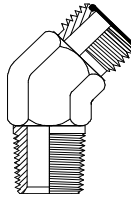

ORFS Male
NPT Male
Page 62

1FO4

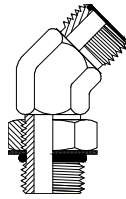

ORFS Male
UNO Male
Page 62

1J4

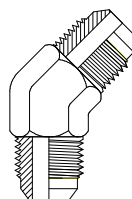

JIC Male
JIC Male
Page 63

1JG4

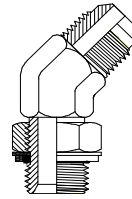

JIC Male
BSPP Adj Male
Page 64

1JN4

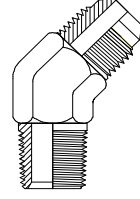

JIC Male
NPT Male
Page 65

1JO4

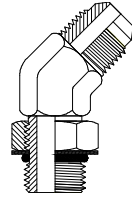

JIC Male
UNO Male
Page 66

1JT4

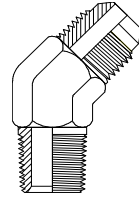

JIC Male
BSPT Male
Page 66

1N4

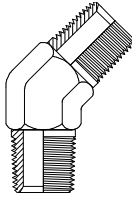

NPT Male
NPT Male
Page 67

1PT4

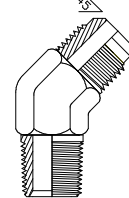

SAE 45 Deg Male
BSPT Male
Page 67

1T4

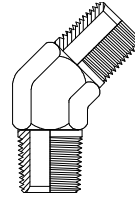

BSPT Male
BSPT Male
Page 67

1TG4

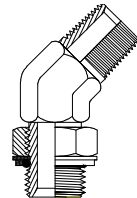

BSPT Male
BSPP Adj Male
Page 67

1TO4

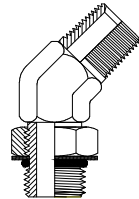

BSPT Male
UNO Male
Page 68

45 Degree

2F4

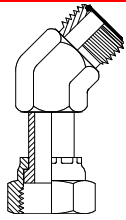

ORFS Male
ORFS Female
Page 68

2GB4

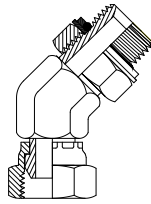

BSPP Male
BSP Female
Page 68

2J4

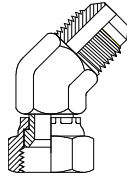

JIC Male
JIC Female
Page 68

2J4-T

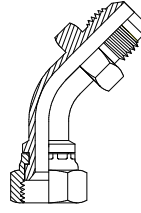

JIC Male
JIC Female
Page 68

2NU4

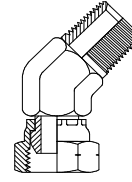

NPT Male
NPSM Female
Page 69

2OJ4

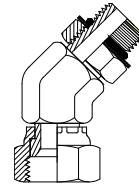

UNO Male
JIC Female
Page 69

2OU4

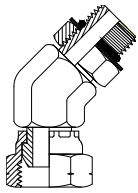

UNO Male
NPSM Female
Page 69

2P4

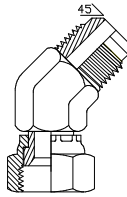

SAE 45 Deg Male
SAE 45 Deg Female
Page 69

2TB4

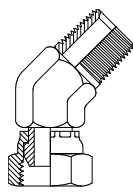

BSPT Male
BSP Female
Page 70

5N4

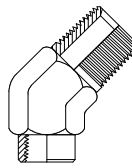

NPT Male
NPT Female
Page 71

5T4

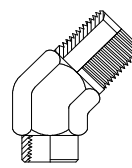

BSPT Male
BSPT Female
Page 71

6F4

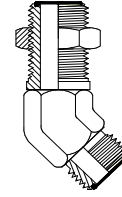

ORFS Bulkhead Male
ORFS Male
Page 71

6J4

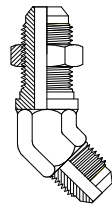

JIC Bulkhead Male
JIC Male
Page 71

7N4

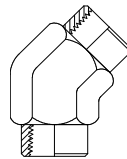

NPT Female
NPT Female
Page 72

7T4

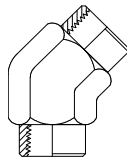

BSPT Female
BSPT Female
Page 72

67 Degree

1JG6

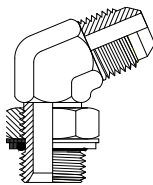

JIC Male
BSPP Adj Male
Page 73

90 Degree

1BG9

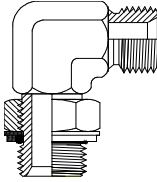

BSPP Male
BSPP Adj Male
Page 74

1C9

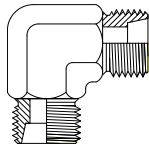

Metric DKL
Metric DKL
Page 122

1CG9

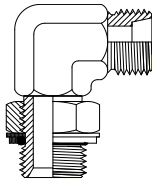

Metric DKL
BSPP Adj Male
Page 124

1CI

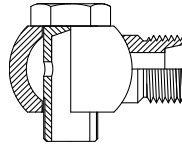

Metric DKL Male
Banjo
Page 125

1CN9

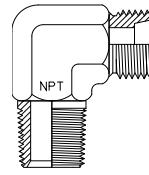

Metric DKL
NPT Male
Page 128

1CO9

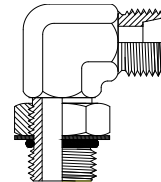

Metric DKL
UNO Male
Page 130

1CT9

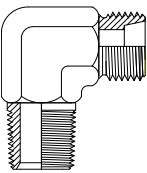

Metric DKL
BSPT Male
Page 132

1D9

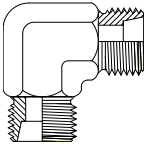

Metric DKS
Metric DKS
Page 123

1DG9

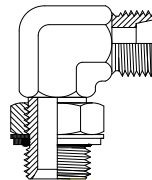

Metric DKL
BSPP Adj Male
Page 125

1DN9

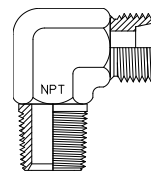

ORFS Male
NPT Male
Page 128

1DO9

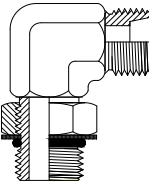

ORFS Male
UNO Male
Page 130

1DT9

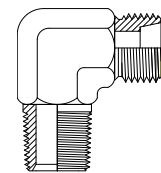

ORFS Male
BSPT Male
Page 132

1F9

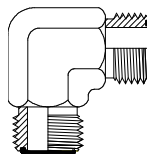

ORFS Male
ORFS Male
Page 74

1FG9

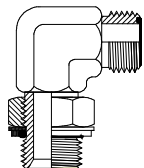

ORFS Male
BSPP Adj Male
Page 74

1FN9

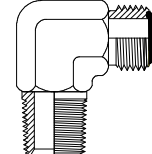

ORFS Male
NPT Male
Page 75

1FO9

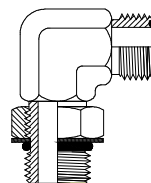

ORFS Male
UNO Male
Page 75

1GG9

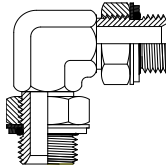

BSPP Adj Male
BSPP Adj Male
Page 76

1GO9

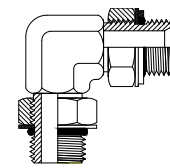

BSPP Adj Male
UNO Male
Page 76

1J9

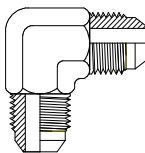

JIC Male
JIC Male
Page 77

1JG9

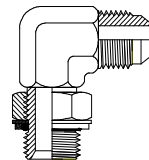

JIC Male
BSPP Adj Male
Page 79

1JG9L

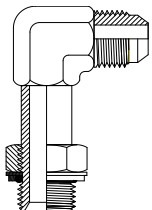

JIC Male
BSPP Adj Male L
Page 79

1JM9

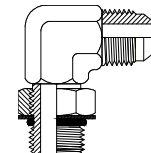

JIC Male
Metric Stud Male
Page 80

1JN9

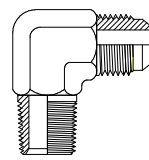

JIC Male
NPT Male
Page 80

1JO9

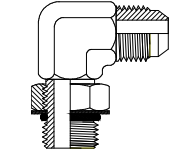

JIC Male
UNO Male
Page 81

1JO9L

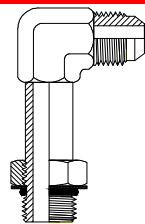

JIC Male
UNO Male
Page 81

1JO9X

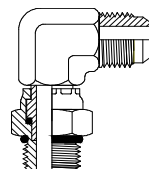

JIC Male
UNO Male Swivel
Page 82

1JT9

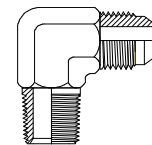

JIC Male
BSPT Male
Page 82

1JT9X

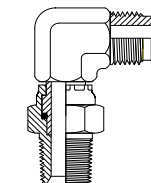

JIC Male
BSPT Male Swivel
Page 83

1N9

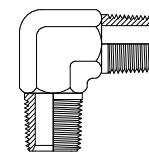

NPT Male
NPT Male
Page 83

1NO9

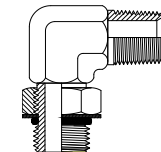

NPT Male
UNO Male
Page 83

90 Degree

1O9

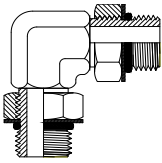

UNO Male
UNO Male
Page 83

1PT9

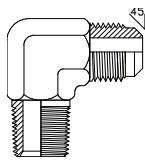

SAE 45 Deg Male
BSPT Male
Page 84

1T9

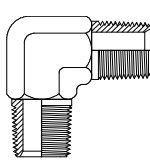

BSPT Male
BSPT Male
Page 84

1TG9

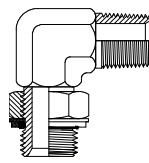

BSPT Male
BSPP Adj Male
Page 84

1TO9

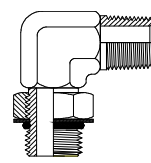

BSPT Male
UNO Male
Page 85

WE

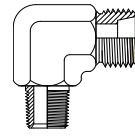

Metric DKL
Metric Taper Male
Page 142

2C9

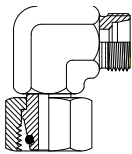

DKL Male
DKL Female
Page 135

2D9

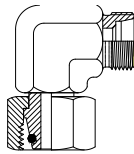

DKS Male
DKS Female
Page 136

2F9

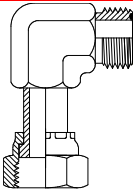

ORFS Male
ORFS Female
Page 85

2GB9

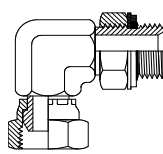

BSPP Adj Male
BSP Female
Page 85

2J9

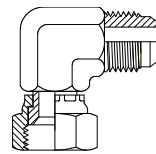

JIC Male
JIC Female
Page 86

2J9-T

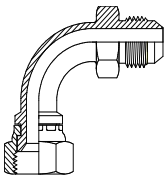

JIC Male
JIC Female
Page 86

2J9-TL

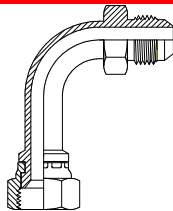

JIC Male
JIC Female
Page 86

2JB9

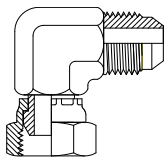

JIC Male
BSP Female
Page 87

2NJ9

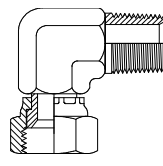

NPT Male
JIC Female
Page 87

2NU9

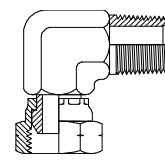

NPT Male
NPSM Female
Page 87

2OB9

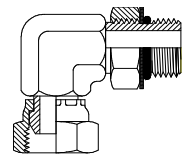

UNO Male
BSP Female
Page 88

2OF9

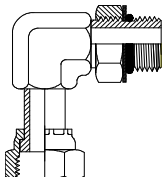

UNO Male
ORFS Female
Page 88

2OJ9

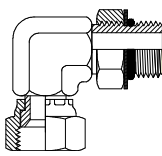

UNO Male
JIC Female
Page 88

2OU9

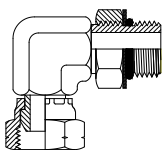

UNO Male
NPSM Female Swivel
Page 88

2P9

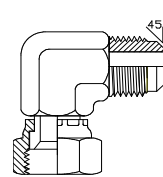

SAE 45 Deg Male
SAE 45 Deg Female
Page 89

2TB9

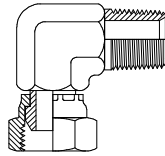

BSPT Male
BSP Female
Page 89

2TB9-T

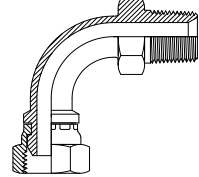

BSPT Male
BSP Female
Page 89

2TJ9

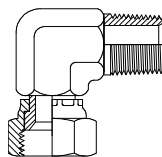

BSPT Male
JIC Female
Page 89

3J9

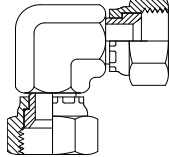

JIC Female
JIC Female
Page 90

5JN9

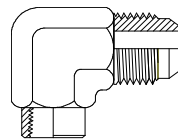

JIC Male
NPT Female
Page 90

5JT9

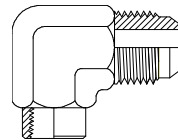

JIC Male
BSPT Female
Page 90

5N9

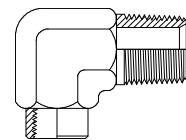

NPT Male
NPT Female
Page 90

90 Degree

509

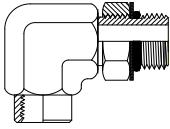

UNO Male
UNO Female
Page 91

50N9

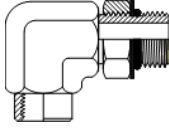

UNO Male
NPT Female
Page 91

5T9

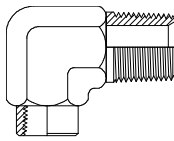

BSPT Male
BSPT Female
Page 91

6C9

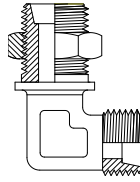

Metric DKL Bulkhead
Metric DKL Male
Page 140

6D9

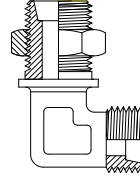

Metric DKS Bulkhead
Metric DKL Male
Page 140

6F9

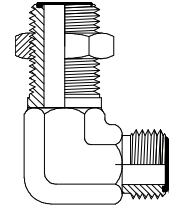

ORFS Bulkhead Male
ORFS Male
Page 91

6J9

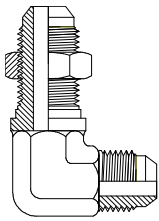

JIC Bulkhead Male
JIC Male
Page 92

7N9

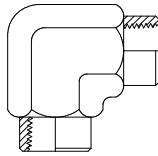

NPT Female
NPT Female
Page 92

7T9

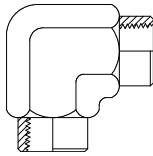

BSPT Female
BSPT Female
Page 92

Tee

A1C

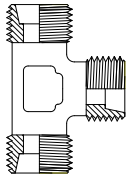

DKL Male
DKL Male
DKL Male
Page 142

A1D

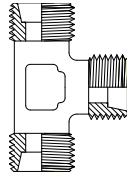

DKS Male
DKS Male
DKS Male
Page 142

A1F

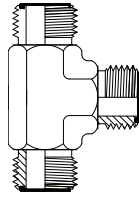

ORFS Male
ORFS Male
ORFS Male
Page 93

A1F6F

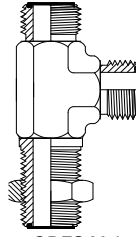

ORFS Male
ORFS Bulkhead Male
ORFS Male
Page 93

A1FF6

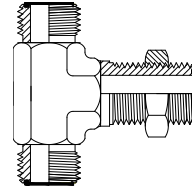

ORFS Male
ORFS Male
ORFS Bulkhead Male
Page 93

A1FFG

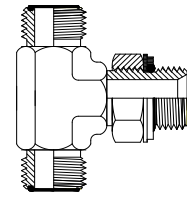

ORFS Male
ORFS Male
BSPP Male
Page 93

A1FFO

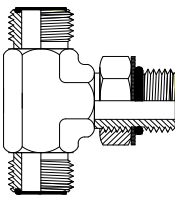

ORFS Male
ORFS Male
UNO Male
Page 94

A1FGF

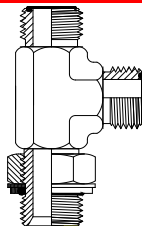

ORFS Male
BSPP Male
ORFS Male
Page 94

A1FOF

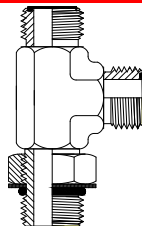

ORFS Male
UNO Male
ORFS Male
Page 94

A1J

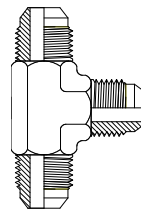

JIC Male
JIC Male
JIC Male
Page 94

A1J6J

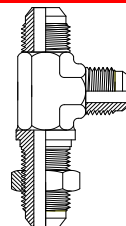

JIC Male
JIC Bulkhead Male
JIC Male
Page 95

A1JGJ

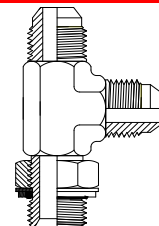

JIC Male
BSPP Male
JIC Male
Page 95

A1JJ6

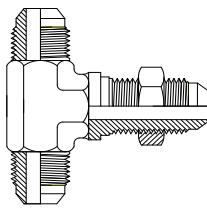

JIC Male
JIC Male
JIC Bulkhead Male
Page 95

A1JJG

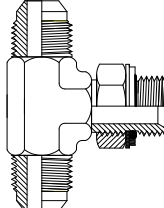

JIC Male
JIC Male
BSPP Adj Male
Page 96

A1JJN

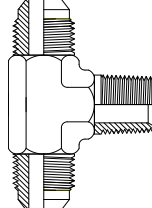

JIC Male
JIC Male
NPT Male
Page 96

A1JJO

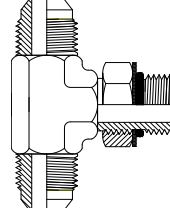

JIC Male
JIC Male
UNO Male
Page 96

A1JJT

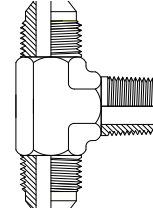

JIC Male
JIC Male
BSPT Male
Page 97

A1JNJ

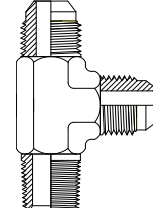

JIC Male
NPT Male
JIC Male
Page 97

A1JOJ

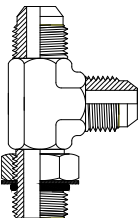

JIC Male
UNO Male
JIC Male
Page 97

A1JTJ

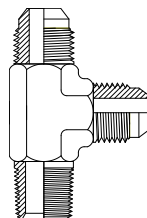

JIC Male
BSPT Male
JIC Male
Page 98

A1N

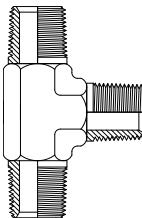

NPT Male
NPT Male
NPT Male
Page 98

A1T

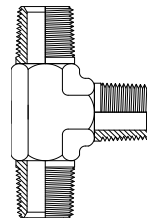

BSPT Male
BSPT Male
BSPT Male
Page 98

A1TGT

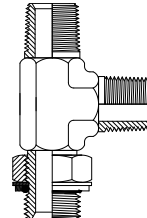

BSPT Male
BSPP Male
BSPT Male
Page 98

A1TGT

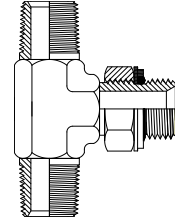

BSPT Male
BSPT Male
BSPP Male
Page 98

Tee

A2B

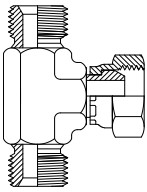

BSPP Male
BSP Female
BSPP Male
Page 99

A2C

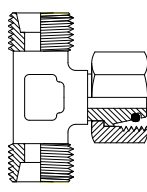

DKL Male
DKL Male
DKOL Female
Page 143

A2D

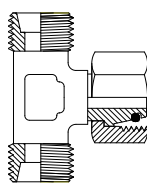

DKS Male
DKS Male
DKOS Female
Page 143

A2F

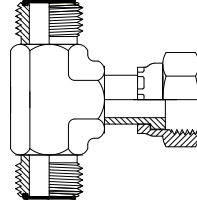

ORFS Male
ORFS Male
ORFS Female
Page 99

A2J

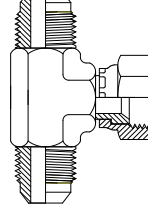

JIC Male
JIC Male
JIC Female
Page 99

A2J2

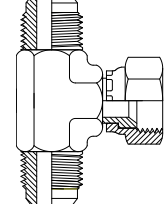

JIC Male
JIC Male
JIC Female
Page 99

A2T

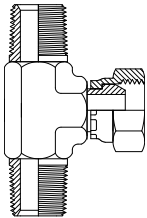

BSPT Male
BSPT Male
BSP Female
Page 100

A3B

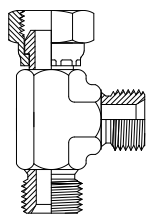

BSPP Male
BSP Female
BSPP Male
Page 100

A3C

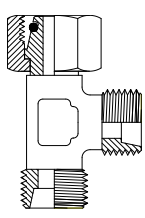

DKL Male
DKOL Female
DKL Male
Page 143

A3D

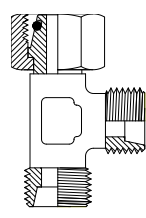

DKS Male
DKOS Female
DKS Male
Page 143

A3F

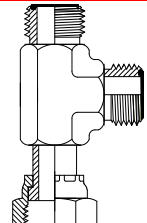

ORFS Male
ORFS Female
ORFS Male
Page 100

A3J

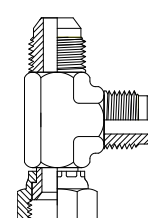

JIC Male
JIC Female
JIC Male
Page 100

A3T

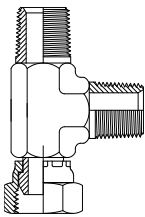

BSPT Male
BSP Female
BSPT Male
Page 100

A3TB

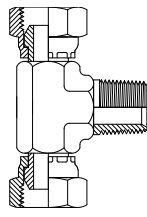

BSP Female
BSP Female
BSPT Male
Page 101

A4B

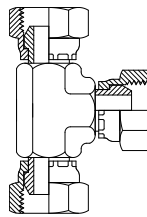

BSP Female
BSP Female
BSP Female
Page 101

A4J

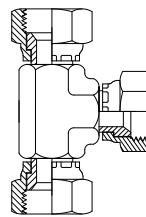

JIC Female
JIC Female
JIC Female
Page 101

A4U

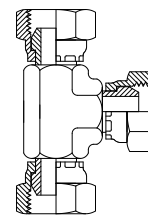

NPSM Female
NPSM Female
NPSM Female
Page 102

A5JJT

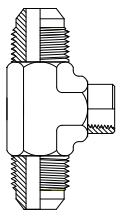

JIC Male
JIC Male
BSPT Female
Page 102

A5N

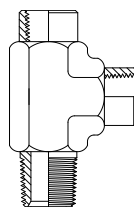

NPT Female
NPT Male
NPT Female
Page 102

A5O

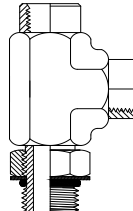

UNO Male
UNO Female
UNO Female
Page 102

A5T

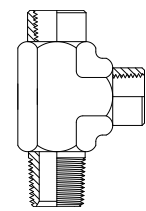

BSPT Female
BSPT Male
BSPT Female
Page 103

A7B

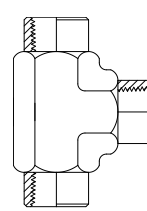

BSPP Female
BSPP Female
BSPP Female
Page 103

A7N

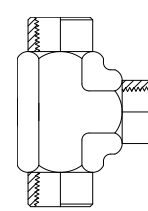

NPT Female
NPT Female
NPT Female
Page 103

Tee - Cross

A7T

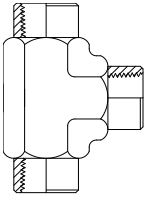

BSPT Female
BSPT Female
BSPT Female
Page 103

ZJ

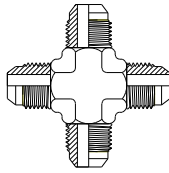

JIC Male
Cross
Page 104

ZN

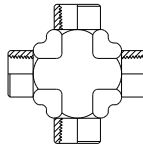

NPT Female
Cross
Page 104

ZT

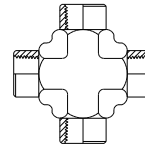

BSPT Female
Cross
Page 104

Bolts Nuts

BBB

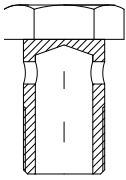

Banjo Bolt
BSP
Page 118

BBM

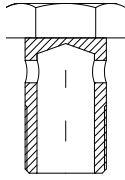

Banjo Bolt
Metric
Page 118

8F



UNF Locknut
Suits ORFS B-head
Page 105

8G



BSPP Locknut
Suits BSPP B-head
Page 105

8J



UNF Locknut
Suits ORFS/JIC B-head
Page 105

SAE Flange

1BFL

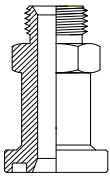

BSPP Male
Code 61 Flange
Page 3

1JFL

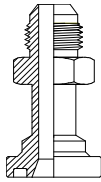

JIC Male
Code 61 Flange
Page 8

1JFL4

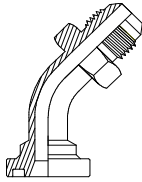

JIC Male
Code 61 Flange
Page 63

1JFL4C

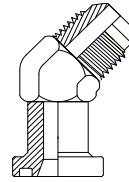

JIC Male
Code 61 Flange
Page 64

1JFL9

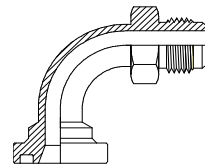

JIC Male
Code 61 Flange
Page 77

1JFL9C

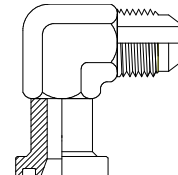

JIC Male
Code 61 Flange
Page 77

1BFLH

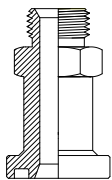

BSPP Male
Code 62 Flange
Page 3

1JFLH

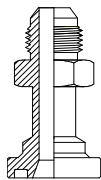

JIC Male
Code 62 Flange
Page 9

1JFLH4

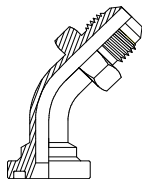

JIC Male
Code 62 Flange
Page 63

1JFLH4C

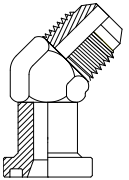

JIC Male
Code 62 Flange
Page 64

1JFLH9

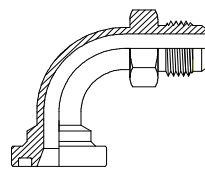

JIC Male
Code 62 Flange
Page 78

1JFLH9C

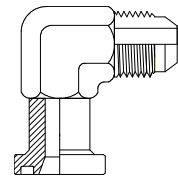

JIC Male
Code 62 Flange
Page 78

4FL

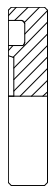

Code 61 Plug
Page 48

4FLH

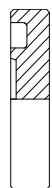

Code 62 Plug
Page 48

4FLHC

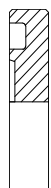

Code 62 Plug
Page 48

FSA

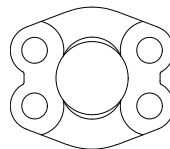

Code 61
One Piece Clamp
Page 110

FSAH

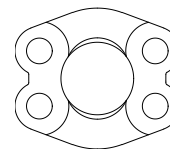

Code 62
One Piece Clamp
Page 110

FSBB

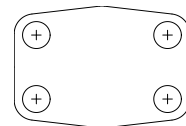

Code 61 Cap
Double Sided
Page 112

FSBBH

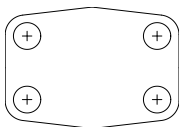

Code 62 Cap
Double Sided
Page 112

FSC

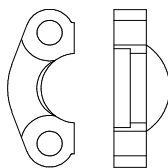

Code 61
Split Clamps
Page 110

FSCH

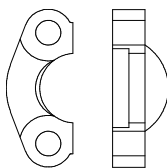

Code 62
Split Clamps
Page 111

FSCHC

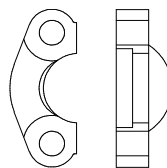

Code 62 CAT
Split Clamps
Page 111

CW

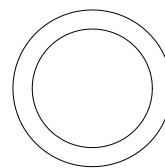

CAT Washer
Use with FSCH
Page 110

FSG

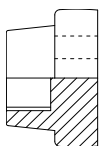

SAE Code 61
BSPP Fixed Female
Page 113

FSGH

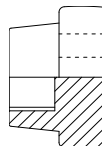

SAE Code 62
BSPP Fixed Female
Page 113

FSG9C

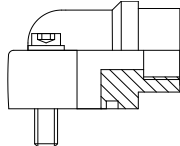

SAE Code 61
BSPP Fixed Female
Page 114

FSGH9C

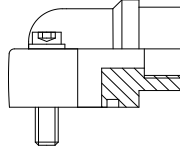

SAE Code 62
BSPP Fixed Female
Page 114

O-Ring and Seals

OR-BSP

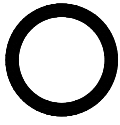

BSPP ADJ. O-Ring
Use with OR-GRR
Page 115

OR-BRR

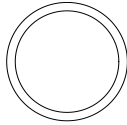

BSPP Retaining Ring
Use with OR-GOR
Page 115

OR-DKO



DKOL / DKOS
Female O-Ring
Page 115

OR-F



ORFS Male
O-Ring
Page 115

OR-FL



SAE Flange
O-Ring
Page 115

OR-G

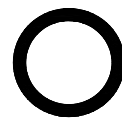

BSPP Male
Encapsulated Seal
Page 116

OR-GBC

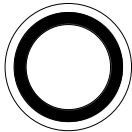

BSPP Bonded Seal
(self centering)
Page 116

OR-GSP



O-Ring Gauge Adaptor
Page 117

OR-M



Metric Encapsulated

OR-MBS

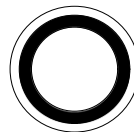

Metric Bonded Seal
Page 117

OR-O

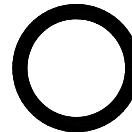

UNO Male O-Ring
Page 117

Gauge Adaptor / Test Point

A9BG

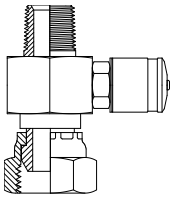

BSPTM x BSP Swivel
BSPP Cross Port
Page 107

A9BT

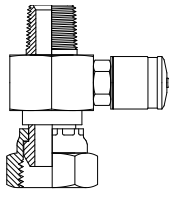

BSPTM x BSP Swivel
BSPT Cross Port
Page 107

A9GG

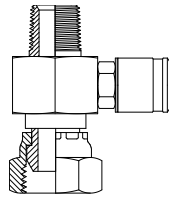

BSPPM x BSP Swivel
BSPP Cross Port
Page 108

A9CG

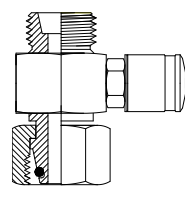

DKL M x DKOL Female
BSPP Cross Port
Page 107

A9FG

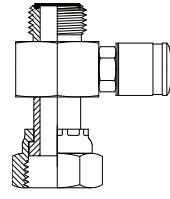

BSPTM x BSP Swivel
BSPP Cross Port
Page 108

A9FO

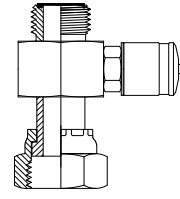

ORFSM x ORFS Swivel
UNO Cross Port
Page 108

Note - Gauge adaptors are standard without Test Points assembled.

A9FT

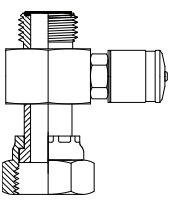

ORFSM x ORFS Swivel
BSPT Cross Port
Page 108

A9JG

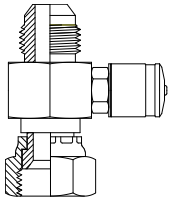

ORFSM x ORFS Swivel
BSPP Cross Port
Page 108

A9JO

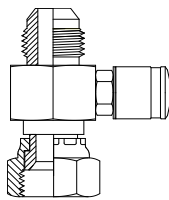

JICM x JIC Swivel
UNO Cross Port
Page 109

A9JT

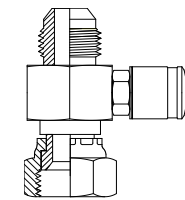

JICM x JIC Swivel
BSPT Cross Port
Page 109

Note - Gauge adaptors are standard without Test Points assembled.

TP

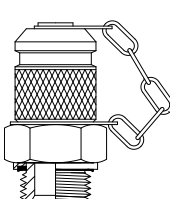

Test Point BSPP
TP
Page 109

TP

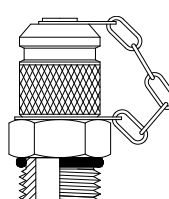

Test Point UNO
TP
Page 109

TP

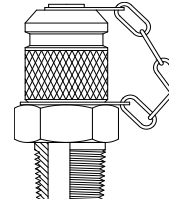

Test Point BSPT
TP
Page 109

TP

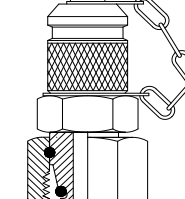

Test Point DKS
TP
Page 109

2GB*GSP

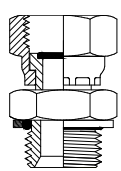

BSPP Gauge Adaptor
BSPPM
Page 106

2JB*GSP

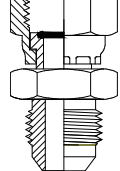

BSPP Gauge Adaptor
JIC Male
Page 106

2NB*GSP

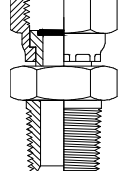

BSPP Gauge Adaptor
NPT Male
Page 106

2TB*GSP

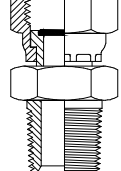

BSPP Gauge Adaptor
BSPT Male
Page 106

1B
BSPP Male x BSPP Male

For use with dowty seals

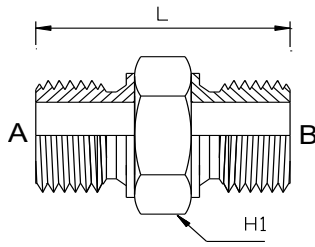

Item No	A-BSPP	B-BSPP	L	H1
1B-0202	-02 1/8-28	-02 1/8-28	23	14
1B-0402	-04 1/4-19	-02 1/8-28	30	19
1B-0404	-04 1/4-19	-04 1/4-19	32	19
1B-0604	-06 3/8-19	-04 1/4-19	34	22
1B-0606	-06 3/8-19	-06 3/8-19	34	22
1B-0804	-08 1/2-14	-04 1/4-19	38	27
1B-0806	-08 1/2-14	-06 3/8-19	38	27
1B-0808	-08 1/2-14	-08 1/2-14	40	27
1B-1008	-10 5/8-14	-08 1/2-14	40	30
1B-1010	-10 5/8-14	-10 5/8-14	40	30
1B-1206	-12 3/4-14	-06 3/8-19	40	32
1B-1208	-12 3/4-14	-08 1/2-14	42	32
1B-1212	-12 3/4-14	-12 3/4-14	44	32
1B-1608	-16 1-11	-08 1/2-14	46	41
1B-1612	-16 1-11	-12 3/4-14	48	41
1B-1616	-16 1-11	-16 1-11	51	41
1B-2012	-20 1.1/4-11	-20 1.1/4-11	50	50
1B-2016	-20 1.1/4-11	-20 1.1/4-11	51	50
1B-2020	-20 1.1/4-11	-20 1.1/4-11	55	50
1B-2416	-24 1.1/2-11	-24 1.1/2-11	59	55
1B-2420	-24 1.1/2-11	-24 1.1/2-11	61	55
1B-2424	-24 1.1/2-11	-24 1.1/2-11	64	55
1B-3224	-32 2-11	-24 1.1/2-11	64	70
1B-3232	-32 2-11	-32 2-11	68	70
1B-4848	-48 3-11	-48 3-11	92	100

- Dowty seals self centering type OR-GBC-see page 116

1G
BSPP Male x BSPP Male

Encapsulated Seal Type

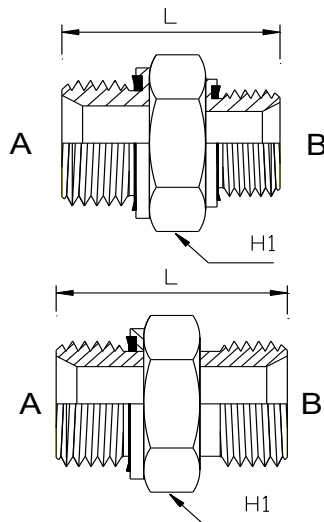

Item No	A-BSPP	B-BSPP		L	H1
1G-0202	-02 1/8-28	-02 1/8-28	*	23	14
1G-0402	-04 1/4-19	-02 1/8-28		31	19
1G-0404	-04 1/4-19	-04 1/4-19	*	32	19
1G-0604	-06 3/8-19	-04 1/4-19		34	22
1G-0606	-06 3/8-19	-06 3/8-19	*	34	22
1G-0804	-08 1/2-14	-04 1/4-19		38	27
1G-0806	-08 1/2-14	-06 3/8-19		38	27
1G-0808	-08 1/2-14	-08 1/2-14	*	40	27
1G2-0808	-08 1/2-14	-08 1/2-14	!	40	27
1G-1204	-12 3/4-14	-04 1/4-19		40	32
1G-1206	-12 3/4-14	-06 3/8-19		40	32
1G-1208	-12 3/4-14	-08 1/2-14		42	32
1G-1212	-12 3/4-14	-12 3/4-14	*	44	32
1G2-1212	-12 3/4-14	-12 3/4-14	!	44	32
1G-1608	-16 1-11	-08 1/2-14		46	41
1G-1612	-16 1-11	-12 3/4-14		48	41
1G-1616	-16 1-11	-16 1-11	*	51	41
1G-2012	-20 1.1/4-11	-12 3/4-14		51	50
1G-2016	-20 1.1/4-11	-16 1-11		53	50
1G-2020	-20 1.1/4-11	-20 1.1/4-11	*	55	50
1G-2416	-24 1.1/2-11	-16 1-11		59	55
1G-2420	-24 1.1/2-11	-20 1.1/4-11		62	55
1G-2424	-24 1.1/2-11	-24 1.1/2-11	*	64	55
1G-3224	-32 2-11	-24 1.1/2-11		67	70
1G-3232	-32 2-11	-32 2-11	*	68	70

* Straight sizes have seal one end only.

! ES Seal both ends

- Ends with no seal can be fitted with O-ring+Retaining Ring page 115

- Replacement encapsulated seals OR-G-** page 116

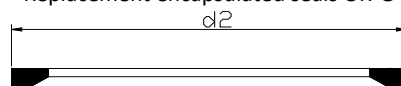

1G*R
BSPP Male x BSPP Male

O-ring + Retaining Ring Type

	Item No	A-BSPP	B-BSPP		L	H1
	1G-0202R	-02 1/8-28	-02 1/8-28	*	23	14
	1G-0402R	-04 1/4-19	-02 1/8-28		31	19
	1G-0404R	-04 1/4-19	-04 1/4-19	*	32	19
	1G-0602R	-06 3/8-19	-02 1/8-28		31	22
	1G-0604R	-06 3/8-19	-04 1/4-19		34	22
	1G-0606R	-06 3/8-19	-06 3/8-19	*	34	22
	1G-0802R	-08 1/2-14	-02 1/8-28		35	27
	1G-0804R	-08 1/2-14	-04 1/4-19		38	27
	1G-0806R	-08 1/2-14	-06 3/8-19		38	27
	1G-0808R	-08 1/2-14	-08 1/2-14	*	40	27
	1G-1206R	-12 3/4-14	-06 3/8-19		40	32
	1G-1208R	-12 3/4-14	-08 1/2-14		42	32
	1G-1212R	-12 3/4-14	-12 3/4-14	*	44	32
	1G-1608R	-16 1-11	-08 1/2-14		46	41
	1G-1612R	-16 1-11	-12 3/4-14		48	41
	1G-1616R	-16 1-11	-16 1-11	*	51	41
	1G-2012R	-20 1.1/4-11	-12 3/4-14		52	50
	1G-2016R	-20 1.1/4-11	-16 1-11		53	50
	1G-2020R	-20 1.1/4-11	-20 1.1/4-11	*	55	50
	1G-2420R	-24 1.1/2-11	-20 1.1/4-11		62	55
1G-2424R	-24 1.1/2-11	-24 1.1/2-11	*	64	55	
1G-3224R	-32 2-11	-24 1.1/2-11		66	70	
1G-3232R	-32 2-11	-32 2-11	*	68	70	

* Straight sizes have seal one end only

- Replacement seals OR-BPA page 115

- To use in BSPP O-ring Ports remove the Retaining Ring

1BM
BSPP Male x Metric Stud Male

	Item No	A-BSPP	B-Metric		L	H1
	1BM-0414ES	-04 1/4-19	-14 M14x1.5		34	19
	1BM-0416ES	-04 1/4-19	-16 M16x1.5		34	22
	1BM-0418ES	-04 1/4-19	-18 M18x1.5			
	1BM-0614ES	-06 3/8-19	-14 M14x1.5		34	22
	1BM-0616ES	-06 3/8-19	-16 M16x1.5			
	1BM-0618ES	-06 3/8-19	-18 M18x1.5			
	1BM-0818ES	-08 1/2-14	-18 M18x1.5			
	1BM-0822ES	-08 1/2-14	-22 M22x1.5			
	1BM-1222ES	-12 3/4-14	-22 M22x1.5		43	32

- BSPP end can be fitted with O-ring+Retaining Ring (OR-BPA)

Use OR-BPA - page 115

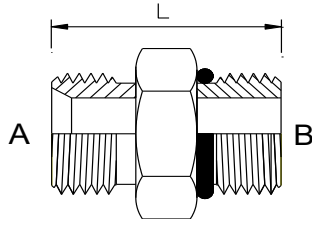
1BO
BSPP Male x UNO Male

Item No	A-BSPP	B-UNO	L	H1
1BO-0407	-04 1/4-19	-07 7/16-20	29	19
1BO-0408	-04 1/4-19	-08 1/2-20	29	19
1BO-0409	-04 1/4-19	-09 9/16-18	29	19
1BO-0412	-04 1/4-19	-12 3/4-16	31	22
1BO-0607	-06 3/8-19	-07 7/16-20	29	19
1BO-0608	-06 3/8-19	-08 1/2-20	29	19
1BO-0609	-06 3/8-19	-09 9/16-18	31	19
1BO-0612	-06 3/8-19	-12 3/4-16	33	22
1BO-0614	-06 3/8-19	-14 7/8-14	37	27
1BO-0809	-08 1/2-14	-09 9/16-18	35	27
1BO-0812	-08 1/2-14	-12 3/4-16	37	27
1BO-0814	-08 1/2-14	-14 7/8-14	39	27
1BO-0817	-08 1/2-14	-17 1.1/16-12	41	32
1BO-1212	-12 3/4-14	-12 3/4-16	38	32
1BO-1214	-12 3/4-14	-14 7/8-14	39	32
1BO-1217	-12 3/4-14	-17 1.1/16-12	41	32
1BO-1219	-12 3/4-14	-19 1.3/16-12	43	36
1BO-1221	-12 3/4-14	-21 1.5/16-12	45	38
1BO-1617	-16 1-11	-17 1.1/16-12	46	41
1BO-1619	-16 1-11	-19 1.3/16-12	48	41
1BO-1621	-16 1-11	-21 1.5/16-12	48	41
1BO-1626	-16 1-11	-26 1.5/8-12	50	50
1BO-2026	-20 1.1/4-11	-26 1.5/8-12	50	50

- BSPP end can be fitted with O-ring+Retaining Ring (OR-BPA)
Use OR-BPA - page 115

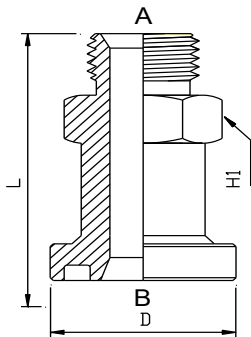
1BFL
BSPP Male x SAE Cd 61 Flange

Item No	A-BSPP	B-CD61	L	H1
1BFL-1220	-12 3/4-14	-20 3/4	57	46
1BFL-1616	-16 1-11	-16 1	62	41

- BSPP end can be fitted with O-ring+Retaining Ring if required. Page 115

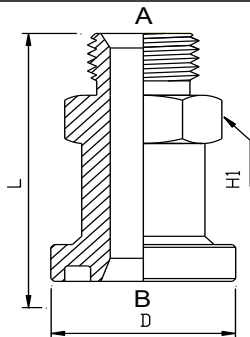
1BFLH
BSPP Male x SAE Cd 62 Flange

Item No	A-BSPP	B-CD62	L	H1
1BFLH-2032	-20 1.1/4-11	-32 2	95	69
1BFLH-2432	-24 1.1/2-11	-32 2	95	69
1BFLH-3232	-32 2-11	-32 2	95	69

- BSPP end can be fitted with O-ring+Retaining Ring if required. Page 115

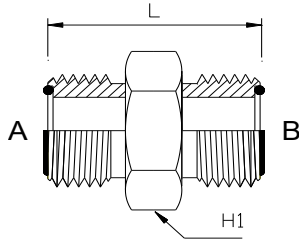
1E
METRIC Flat Face Male x METRIC Flat Face Male

Item No	A-METRIC	B-METRIC	L	H1
1E-2222	-22 22x1.5	-22 22x1.5	33	24
1E-3030	-30 30x2.0	-30 30x2.0	39	32

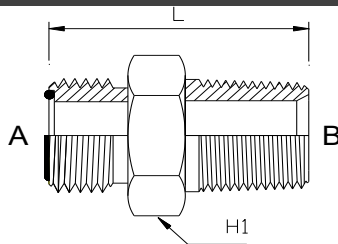
1ET
METRIC Flat Face Male x BSPT Male

Item No	A-METRIC	B-BSPT	L	H1
1ET-1404	-14 14x1.5	-04 1/4-19	33	17
1ET-1406	-14 14x1.5	-06 3/8-19	35	19
1ET-1604	-16 16x1.5	-04 1/4-19	34	17
1ET-1606	-16 16x1.5	-06 3/8-19	36	19
1ET-1608	-16 16x1.5	-08 1/2-14	40	22
1ET-1806	-18 18x1.5	-06 3/8-19	37	19
1ET-1808	-18 18x1.5	-08 1/2-14	41	22

1F
ORFS Male x ORFS Male

SAE Specification

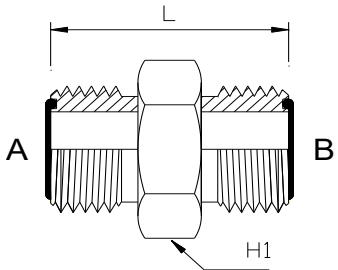

Item No	A-ORFS	B-ORFS	L	H1
1F-0909	-09 9/16-18	-09 9/16-18	27	15.9
1F-1109	-11 11/16-16	-09 9/16-18	30	19.1
1F-1111	-11 11/16-16	-11 11/16-16	31	19.1
1F-1311	-13 13/16-16	-11 11/16-16	34	22.2
1F-1313	-13 13/16-16	-13 13/16-16	35	22.2
1F-1613	-16 1-14	-13 13/16-16	40	27.0
1F-1616	-16 1-14	-16 1-14	43	27.0
1F-1913	-19 1.3/16-12	-13 13/16-16	43	31.8
1F-1916	-19 1.3/16-12	-16 1-14	46	31.8
1F-1919	-19 1.3/16-12	-19 1.3/16-12	47	31.8
1F-2319	-23 1.7/16-12	-19 1.3/16-12	49	38.1
1F-2323	-23 1.7/16-12	-23 1.7/16-12	49	38.1
1F-2723	-27 1.11/16-12	-23 1.7/16-12	51	44.5
1F-2727	-27 1.11/16-12	-27 1.11/16-12	51	44.5
1F-3232	-32 2-12	-32 2-12	53	54.0

1FG
ORFS Male x BSPP Male Encapsulated Seal Type

Item No	A-ORFS	B-BSPP	L	H1
1FG-0902	-09 9/16-18	-02 1/8-28	26	17
1FG-0904	-09 9/16-18	-04 1/4-19	29	19
1FG-0906	-09 9/16-18	-06 3/8-19	31	22
1FG-0908	-09 9/16-18	-08 1/2-14	36	27
1FG-1104	-11 11/16-16	-04 1/4-19	31	19
1FG-1106	-11 11/16-16	-06 3/8-19	33	22
1FG-1108	-11 11/16-16	-08 1/2-14	37	27
1FG-1304	-13 13/16-16	-04 1/4-19	34	22
1FG-1306	-13 13/16-16	-06 3/8-19	34	22
1FG-1308	-13 13/16-16	-08 1/2-14	39	27
1FG-1312	-13 13/16-16	-12 3/4-14	43	32
1FG-1608	-16 1-14	-08 1/2-14	41	27
1FG-1612	-16 1-14	-12 3/4-14	45	32
1FG-1908	-19 1.3/16	-08 1/2-14	45	32
1FG-1912	-19 1.3/16-12	-12 3/4-14	46	32
1FG-1916	-19 1.3/16-12	-16 1-11	50	41
1FG-2312	-23 1.7/16-12	-12 3/4-14	48	41
1FG-2316	-23 1.7/16-12	-16 1-11	50	41
1FG-2716	-27 1.11/16-12	-16 1-11	54	50
1FG-2720	-27 1.11/16-12	-20 1.1/4-11	56	50
1FG-3224	-32 2-12	-24 1.1/2-11	58	55

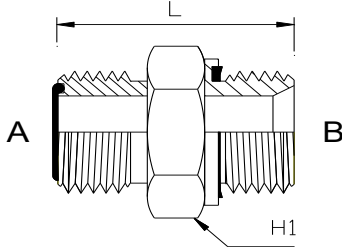
1FG*R
ORFS Male x BSPP Male O-Ring + Retaining Ring Type

Item No	A-ORFS	B-BSPP	L	H1
1FG-0902R	-09 9/16-18	-02 1/8-28	26	17
1FG-0904R	-09 9/16-18	-04 1/4-19	29	19
1FG-0906R	-09 9/16-18	-06 3/8-19	31	22
1FG-1104R	-11 11/16-16	-04 1/4-19	31	19
1FG-1106R	-11 11/16-16	-06 3/8-19	33	22
1FG-1108R	-11 11/16-16	-08 1/2-14	33	27
1FG-1306R	-13 13/16-16	-06 3/8-19	34	22
1FG-1308R	-13 13/16-16	-08 1/2-14	39	27
1FG-1312R	-13 13/16-16	-12 3/4-14	43	32
1FG-1608R	-16 1-14	-08 1/2-14	41	27
1FG-1612R	-16 1-14	-12 3/4-14	45	32
1FG-1908R	-19 1.3/16-12	-08 1/2-14	45	32
1FG-1912R	-19 1.3/16-12	-12 3/4-14	46	32
1FG-1916R	-19 1.3/16-12	-16 1-11	50	41
1FG-2312R	-23 1.7/16-12	-12 3/4-14	48	41
1FG-2316R	-23 1.7/16-12	-16 1-11	50	41
1FG-2320R	-23 1.7/16-12	-20 1.1/4-11	50	50
1FG-2720R	-27 1.11/16-12	-20 1.1/4-11	56	50
1FG-2724R	-27 1.11/16-12	-24 1.1/2-11	58	55
1FG-3224R	-32 2-12	-24 1.1/2-11	58	55

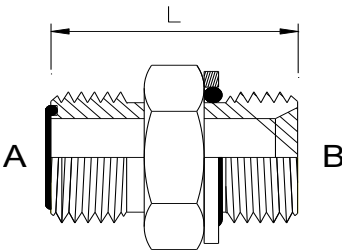
1FM
ORFS Male x METRIC Male

Item No	A-ORFS	B-METRIC	L	H1
1FM-0912	-09 9/16-18	-12 M12x1.5	31	17
1FM-1114	-11 11/16-16	-14 M14x1.5	33	19
1FM-1116	-11 11/16-16	-18 M18x1.5	33	22
1FM-1118	-11 11/16-16	-18 M18x1.5	34	24
1FM-1318	-13 13/16-16	-18 M18x1.5	35	24
1FM-1322	-13 13/16-16	-22 M22x1.5	39	27
1FM-1622	-16 1-14	-22 M22x1.5	42	27
1FM-1922	-19 1.3/16-12	-22 M22x1.5	45	32

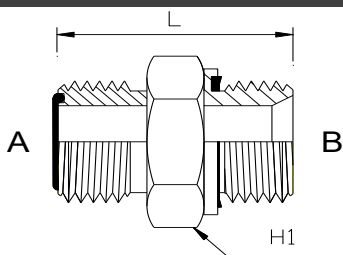

-Metric end is Encapsulated Seal type

1FN
ORFS Male x NPT Male

SAE Specification

Item No	A-ORFS	B-NPT	L	H1
1FN-0902	-09 9/16-18	-02 1/8-27	27	15.88
1FN-0904	-09 9/16-18	-04 1/4-18	32	15.88
1FN-0906	-09 9/16-18	-06 3/8-14	32	19.05
1FN-0908	-09 9/16-18	-08 1/2-14	42	23.80
1FN-1102	-11 11/16-15	-02 1/8-27	31	19.05
1FN-1104	-11 11/16-16	-04 1/4-18	34	19.05
1FN-1106	-11 11/16-16	-06 3/8-18	34	19.05
1FN-1108	-11 11/16-16	-08 1/2-14	39	23.80
1FN-1306	-13 13/16-16	-06 3/8-18	37	23.80
1FN-1308	-13 13/16-16	-08 1/2-14	42	23.80
1FN-1312	-13 13/16-16	-12 3/4-14	42	31.75
1FN-1608	-16 1-14	-08 1/2-14	46	27.00
1FN-1612	-16 1-14	-12 3/4-14	46	31.75
1FN-1908	-19 1.3/16-12	-08 1/2-14	49	31.75
1FN-1912	-19 1.3/16-12	-12 3/4-14	49	31.75
1FN-1916	-19 1.3/16-12	-16 1-11.5	52	38.10
1FN-2312	-23 1.7/16-12	-12 3/4-14	51	38.10
1FN-2316	-23 1.7/16-12	-16 1-11.5	56	38.10
1FN-2320	-23 1.7/16-12	-20 1.1/4-11.5	58	44.50
1FN-2720	-27 1.11/16-12	-20 1.1/4-11.5	58	44.50
1FN-3224	-32 2-12	-20 1.1/2-11.5	61	54.00

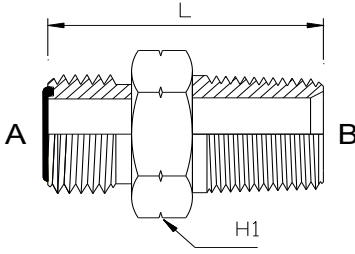
1FO
ORFS Male x UNO Male

SAE Specification

Item No	A-ORFS	B-UNO	L	H1
1FO-0907	-09 9/16-18	-07 7/16-20	29	15.88
1FO-0909	-09 9/16-18	-09 9/16-18	31	19.05
1FO-0912	-09 9/16-18	-12 3/4-16	34	22.23
1FO-1107	-11 11/16-16	-07 7/16-20	34	19.05
1FO-1109	-11 11/16-16	-09 9/16-18	32	19.05
1FO-1112	-11 11/16-16	-12 3/4-16	35	22.23
1FO-1114	-11 11/16-16	-14 7/8-14	38	26.97
1FO-1307	-13 13/16-16	-07 7/16-20	36	22.23
1FO-1309	-13 13/16-16	-09 9/16-18	37	22.23
1FO-1312	-13 13/16-16	-12 3/4-16	37	22.23
1FO-1314	-13 13/16-16	-14 7/8-14	40	26.97
1FO-1317	-13 13/16-16	-17 1.1/16-12	44	31.75
1FO-1321	-13 13/16-16	-21 1.5/16-12	46	38.10
1FO-1612	-16 1-14	-12 3/4-16	45	26.97
1FO-1614	-16 1-14	-14 7/8-14	43	26.97
1FO-1617	-16 1-14	-17 1.1/16-12	47	31.75
1FO-1621	-16 1-14	-21 1.5/16-12	49	38.1
1FO-1912	-19 1.3/16-12	-12 3/4-16	49	31.75
1FO-1914	-19 1.3/16-12	-14 7/8-14	51	31.75
1FO-1917	-19 1.3/16-12	-17 1.1/16-12	49	31.75
1FO-1921	-19 1.3/16-12	-21 1.5/16-12	50	38.10
1FO-2317	-23 1.7/16-12	-17 1.1/16-12	54	38.10
1FO-2321	-23 1.7/16-12	-21 1.5/16-12	50	38.10
1FO-2326	-23 1.7/16-12	-26 1.5/8-12	52	47.63
1FO-2721	-27 1.11/16-12	-21 1.5/16-12	52	44.45
1FO-2726	-27 1.11/16-12	-26 1.5/8-12	52	47.63
1FO-2730	-27 1.11/16-12	-30 1.7/8-12	54	53.98
1FO-3226	-32 2-12	-26 1.5/8-12	54	53.98
1FO-3230	-32 2-12	-30 1.7/8-12	54	53.98

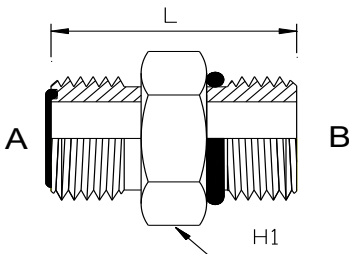

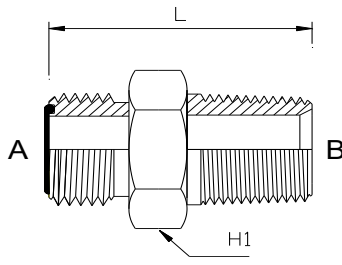
1FT
ORFS Male x BSPT Male

Item No	A-ORFS	B-BSPT	L	H1
1FT-0902	-09 9/16-18	-02 1/8-28	39	17
1FT-0904	-09 9/16-18	-04 1/4-19	33	17
1FT-0906	-09 9/16-18	-08 1/2-14	33	19
1FT-0908	-09 9/16-18	-08 1/2-14	39	22
1FT-1104	-11 11/16-16	-04 1/4-19	35	19
1FT-1106	-11 11/16-16	-06 3/8-19	35	19
1FT-1108	-11 11/16-16	-08 1/2-14	41	22
1FT-1304	-13 13/16-16	-04 1/4-19	38	22
1FT-1306	-13 13/16-16	-06 3/8-19	38	22
1FT-1308	-13 13/16-16	-08 1/2-14	43	22
1FT-1312	-13 13/16-16	-12 3/4-12	44	32
1FT-1608	-16 1-14	-08 1/2-14	36	27
1FT-1612	-16 1-14	-12 3/4-12	45	30
1FT-1908	-19 1.3/16-12	-08 1/2-14	47	32
1FT-1912	-19 1.3/16-12	-12 3/4-12	47	32
1FT-1916	-19 1.3/16-12	-16 1-12	47	32
1FT-2312	-23 1.7/16-12	-12 3/4-12	52	38
1FT-2316	-23 1.7/16-12	-16 1-12	59	38
1FT-2720	-27 1.11/16-12	-20 1.1/4-11	63	46

1J
JIC Male x JIC Male

SAE Specification

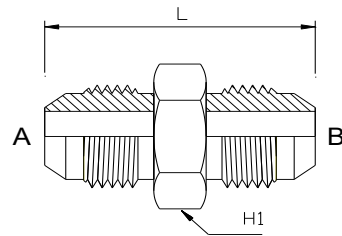

Item No	A-JIC	B-JIC	L	H1
1J-0606	-06 3/8-24	-06 3/8-24	31	11.1
1J-0707	-07 7/16-20	-07 7/16-20	35	12.7
1J-0807	-08 1/2-20	-07 7/16-20	35	14.3
1J-0808	-08 1/2-20	-08 1/2-20	35	14.3
1J-0907	-09 9/16-18	-09 9/16-18	36	15.9
1J-0908	-09 9/16-18	-08 1/2-20	36	15.9
1J-0909	-09 9/16-18	-09 9/16-18	36	15.9
1J-1207	-12 3/4-16	-07 7/16-20	38	20.6
1J-1209	-12 3/4-16	-09 9/16-18	39	20.6
1J-1212	-12 3/4-16	-12 3/4-16	41	20.6
1J-1409	-14 7/8-14	-09 9/16-18	43	23.8
1J-1412	-14 7/8-14	-12 3/4-16	45	23.8
1J-1414	-14 7/8-14	-14 7/8-14	48	23.8
1J-1709	-17 1.1/16-12	-09 9/16-18	47	28.6
1J-1712	-17 1.1/16-12	-12 3/4-16	50	28.6
1J-1714	-17 1.1/16-12	-14 7/8-14	52	28.6
1J-1717	-17 1.1/16-12	-17 1.1/16-12	55	28.6
1J-1917	-19 1.3/16-12	-17 1.1/16-12	55	31.8
1J-1919	-19 1.3/16-12	-19 1.3/16-12	56	31.8
1J-2114	-21 1.5/16-12	-14 7/8-14	53	34.9
1J-2117	-21 1.5/16-12	-17 1.1/16-12	56	34.9
1J-2121	-21 1.5/16-12	-21 1.5/16-12	57	34.9
1J-2621	-26 1.5/8-12	-21 1.5/16-12	61	42.9
1J-2626	-26 1.5/8-12	-26 1.5/8-12	62	42.9
1J-3026	-30 1.7/8-12	-26 1.5/8-12	67	50.8
1J-3030	-30 1.7/8-12	-30 1.7/8-12	70	50.8
1J-4030	-40 2.1/2-12	-30 1.7/8-12	84	66.7
1J-4040	-40 2.1/2-12	-40 2.1/2-12	86	66.7

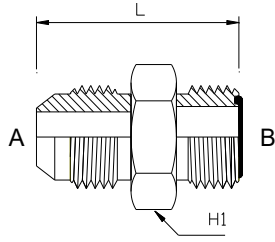
1JE
JIC Male x METRIC Flat Face Male

Item No	A-JIC	B-METRIC	L	H1
1JE-0916	-09 9/16-18	-16 M16x1.5	37	19
1JE-0918	-09 9/16-18	-18 M18x1.5	38	20
1JE-1222	-12 3/4-16	-22 M22x1.5	40	22

1JF
JIC Male x ORFS Male

SAE Specification

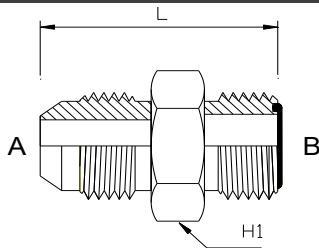

Item No	A-JIC	B-ORFS	L	H1
1JF-0709	-07 7/16-20	-09 9/16-18	32	15.9
1JF-0711	-07 7/16-20	-11 11/16-16	34	19.1
1JF-0713	-07 7/16-20	-13 13/16-16	36	22.2
1JF-0909	-09 9/16-18	-09 9/16-18	35	15.9
1JF-0911	-09 9/16-18	-11 11/16-16	34	19.1
1JF-0913	-09 9/16-18	-13 13/16-16	37	22.2
1JF-1211	-12 3/4-16	-11 11/16-16	38	22.2
1JF-1213	-12 3/4-16	-13 13/16-16	39	22.2
1JF-1413	-14 7/8-14	-13 13/16-16	40	25.4
1JF-1416	-14 7/8-14	-16 1-14	47	27.0
1JF-1716	-17 1.1/16-12	-16 1-14	50	31.8
1JF-1719	-17 1.1/16-12	-19 1.3/16-12	51	31.8
1JF-2119	-21 1.5/16-12	-19 1.3/16-12	55	38.1
1JF-2123	-21 1.5/16-12	-23 1.7/16-12	55	38.1
1JF-2627	-26 1.5/8-12	-27 1.11/16-12	58	44.5

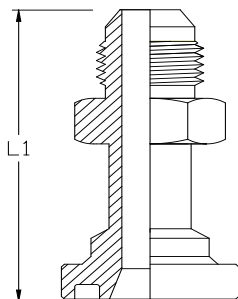
1JFL
JIC Male x SAE Cd 61 Flange

Item No	A-JIC	B-CD61	L1
1JFL-1208	-12 3/4-16	-08 1/2	66
1JFL-1212	-12 3/4-16	-12 3/4	66
1JFL-1412	-14 7/8-14	-12 3/4	68
1JFL-1712	-17 1.1/16-12	-12 3/4	70
1JFL-1716	-17 1.1/16-12	-16 1	72
1JFL-1720	-17 1.1/16-12	-20 1.1/4	72
1JFL-2112	-21 1.5/16-12	-12 3/4	70
1JFL-2116	-21 1.5/16-12	-16 1	72
1JFL-2120	-21 1.5/16-12	-20 1.1/4	72
1JFL-2124	-21 1.5/16-12	-24 1.1/2	72
1JFL-2132	-21 1.5/16-12	-32 2	74
1JFL-2616	-26 1.5/8-12	-16 1	72
1JFL-2620	-26 1.5/8-12	-20 1.1/4	78
1JFL-2624	-26 1.5/8-12	-24 1.1/2	78
1JFL-2632	-26 1.5/8-12	-32 2	89
1JFL-3024	-30 1.7/8-12	-24 1.1/2	90
1JFL-3032	-30 1.7/8-12	-32 2	95
1JFL-4032	-40 2-12	-32 2	101

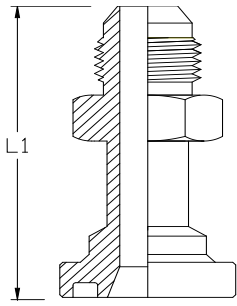
1JFLH
JIC Male x SAE Cd 62 Flange

Item No	A-JIC	B-CD62	L1
1JFLH-1208	-12 3/4-16	-08 1/2	66
1JFLH-1212	-12 3/4-16	-12 3/4	70
1JFLH-1712	-17 1.1/16-12	-12 3/4	70
1JFLH-1716	-17 1.1/16-12	-16 1	72
1JFLH-1720	-17 1.1/16-12		74
1JFLH-2112	-21 1.5/16-12	-12 3/4	78
1JFLH-2116	-21 1.5/16-12	-16 1	72
1JFLH-2120	-21 1.5/16-12	-20 1.1/4	78
1JFLH-2124	-21 1.5/16-12	-24 1.1/2	86
1JFLH-2616	-26 1.5/8-12	-16 1	71
1JFLH-2620	-26 1.5/8-12	-20 1.1/4	78
1JFLH-2624	-26 1.5/8-12	-24 1.1/2	86
1JFLH-3024	-30 1.7/8-12	-24 1.1/2	104

1JG
JIC Male x BSPP Male

Encapsulated Seal Type

	Item No	A-JIC	B-BSPP		L	H1
	1JG-0702	-07 7/16-20	-02 1/8-28		31	14
	1JG-0704	-07 7/16-20	-04 1/4-19		33	19
	1JG-0706	-07 7/16-20	-06 3/8-19		34	22
	1JG-0708	-07 7/16-20	-08 1/2-14		41	27
	1JG-0712	-07 7/16-20	-12 3/4-14		40	32
	1JG-0802	-08 1/2-20	-02 1/8-28		30	14
	1JG-0804	-08 1/2-20	-04 1/4-19		33	19
	1JG-0806	-08 1/2-20	-06 3/8-19		37	22
	1JG-0902	-09 9/16-18	-02 1/8-28		31	17
	1JG-0904	-09 9/16-18	-04 1/4-19		32	19
	1JG-0906	-09 9/16-18	-06 3/8-19		34	22
	1JG-0908	-09 9/16-18	-08 1/2-14		39	27
	1JG-0912	-09 9/16-18	-12 3/4-14		41	32
	1JG-1204	-12 3/4-16	-04 1/4-19		36	22
	1JG-1206	-12 3/4-16	-06 3/8-19		37	22
	1JG-1208	-12 3/4-16	-08 1/2-14		42	27
	1JG-1212	-12 3/4-16	-12 3/4-14		44	32
	1JG-1216	-12 3/4-16	-16 1-11		51	41
	1JG-1406	-14 7/8-14	-06 3/8-19		40	24
	1JG-1408	-14 7/8-14	-08 1/2-14		45	27
	1JG-1412	-14 7/8-14	-12 3/4-14		49	32
	1JG-1416	-14 7/8-14	-16 1-11		53	41
	1JG-1704	-17 1.1/16-12	-04 1/4-19		45	30
	1JG-1706	-17 1.1/16-12	-06 3/8-19		47	30
	1JG-1708	-17 1.1/16-12	-08 1/2-14		49	30
	1JG-1712	-17 1.1/16-12	-12 3/4-12		49	30
	1JG-1716	-17 1.1/16-12	-16 1-11		54	41
	1JG-1720	-17 1.1/16-12	-20 1.1/4-11		57	50
	1JG-1724	-17 1.1/16-12	-24 1.1/2-11		59	50
	1JG-1912R	-19 1.3/16-12	-12 3/4-14	Ret. Ring type	49	32
	1JG-1916R	-19 1.3/16-12	-16 1-11	Ret. Ring type	53	41
	1JG-2108	-21 1.5/16-12	-08 1/2-14		51	36
	1JG-2112	-21 1.5/16-12	-12 3/4-14		53	36
	1JG-2116	-21 1.5/16-12	-16 1-11		55	41
	1JG-2120	-21 1.5/16-12	-20 1.1/4-11		58	50
	1JG-2124	-21 1.5/16-12	-24 1.1/2-11		60	55
	1JG-2132	-21 1.5/16-12	-32 2-11		53	65
	1JG-2612	-26 1.5/8-12	-12 3/4-14		53	50
	1JG-2616	-26 1.5/8-12	-16 1-11		57	50
	1JG-2620	-26 1.5/8-12	-20 1.1/4-11		60	50
1JG-2624	-26 1.5/8-12	-24 1.1/2-11		61	55	
1JG-2632	-26 1.5/8-12	-32 2-11		67	70	
1JG-3016	-30 1.7/8-12	-16 1-11		64	55	
1JG-3020	-30 1.7/8-12	-20 1.1/4-11		66	55	
1JG-3024	-30 1.7/8-12	-24 1.1/2-11		64	55	
1JG-3032	-30 1.7/8-12	-32 2-11		70	70	
1JG-4032	-40 2.1/2-12	-32 2-11		77	70	
	1JG-1206ES-E70	-12 3/4-16	-06 3/8-19	Encs. Seal type	70	22
	1JG-1206ES-E95	-12 3/4-16	-06 3/8-19	Encs. Seal type	95	22
	1JG-1206-E70	-12 3/4-16	-06 3/8-19	*	70	22
	1JG-1206-E95	-12 3/4-16	-06 3/8-19	*	95	22

* E70 and E95 are for use with Dowty Seals (see OR-GBC) on page..... 116

1JG*R
JIC Male x BSPP Male

O-Ring + Retaining Ring Type

	Item No	A-JIC	B-BSPP	L	H1
	1JG-0702R	-07 7/16-20	-02 1/8-28	28	14
	1JG-0704R	-07 7/16-20	-04 1/4-19	33	19
	1JG-0706R	-07 7/16-20	-06 3/8-19	34	22
	1JG-0708R	-07 7/16-20	-08 1/2-14	41	27
	1JG-0802R	-08 1/2-20	-02 1/8-28	30	14
	1JG-0804R	-08 1/2-20	-04 1/4-19	33	19
	1JG-0902R	-09 9/16-18	-02 1/8-28	31	17
	1JG-0904R	-09 9/16-18	-04 1/4-19	32	19
	1JG-0906R	-09 9/16-18	-06 3/8-19	34	22
	1JG-0908R	-09 9/16-18	-08 1/2-14	39	27
	1JG-0912R	-09 9/16-18	-12 3/4-14	41	32
	1JG-1204R	-12 3/4-16	-04 1/4-19	36	22
	1JG-1206R	-12 3/4-16	-06 3/8-19	37	22
	1JG-1208R	-12 3/4-16	-08 1/2-14	42	27
	1JG-1212R	-12 3/4-16	-12 3/4-14	44	32
	1JG-1216R	-12 3/4-16	-16 1-11	51	41
	1JG-1406R	-14 7/8-14	-06 3/8-19	40	24
	1JG-1408R	-14 7/8-14	-08 1/2-14	45	27
	1JG-1412R	-14 7/8-14	-12 3/4-14	49	32
	1JG-1416R	-14 7/8-14	-16 1-11	53	41
	1JG-1706R	-17 1.1/16-12	-06 3/8-19	47	30
	1JG-1708R	-17 1.1/16-12	-08 1/2-14	49	30
	1JG-1712R	-17 1.1/16-12	-12 3/4-12	49	30
	1JG-1716R	-17 1.1/16-12	-16 1-11	54	41
	1JG-1720R	-17 1.1/16-12	-20 1.1/4-11	57	50
	1JG-1912R	-19 1.3/16-12	-12 3/4-14	49	32
	1JG-1916R	-19 1.3/16-12	-16 1-11	53	41
	1JG-2112R	-21 1.5/16-12	-12 3/4-14	53	36
	1JG-2116R	-21 1.5/16-12	-16 1-11	55	41
	1JG-2120R	-21 1.5/16-12	-20 1.1/4-11	58	50
	1JG-2124R	-21 1.5/16-12	-24 1.1/2-11	60	55
	1JG-2616R	-26 1.5/8-12	-16 1-11	57	50
	1JG-2620R	-26 1.5/8-12	-20 1.1/4-11	60	50
	1JG-2624R	-26 1.5/8-12	-24 1.1/2-11	61	55
	1JG-3020R	-30 1.7/8-12	-20 1.1/4-11	66	55
	1JG-3024R	-30 1.7/8-12	-24 1.1/2-11	64	55
	1JG-3032R	-30 1.7/8-12	-32 2-11	70	65
	1JG-4032R	-40 2.1/2-12	-32 2-11	77	65

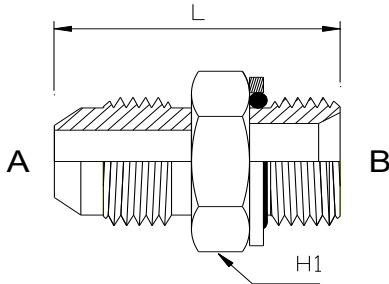

- O-Rings and Retaining rings also available separately.

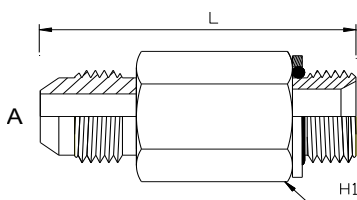

	1JG-1206R-E70	-12 3/4-16	-06 3/8-19	70	22
	1JG-1206R-E95	-12 3/4-16	-06 3/8-19	95	22
	1JG-1408R-E100	-14 7/8-14	-08 1/2-14	100	27

- O-Rings and Retaining rings also available separately.

1JI
JIC Male x BSP Banjo

	Item No	A-JIC	B-Banjo	L
	1JI-0704	-07 7/16-20	-04 1/4	38
	1JI-0904	-09 9/16-18	-04 1/4	38
	1JI-0906	-09 9/16-18	-06 3/8	42
	1JI-1206	-12 3/4-16	-06 3/8	46
	1JI-1208	-12 3/4-16	-08 1/2	48

1JM
JIC Male x Metric Stud Male

	Item No	A-JIC	B-Metric	L	H1
	1JM-0706	-07 7/16-20	-06 M06x1.0	28	12
	1JM-0708	-07 7/16-20	-08 M08x1.0	28	12
	1JM-0710ES	-07 7/16-20	-10 M10x1.0	30	14
	1JM-0712ES	-07 7/16-20	-12 M12x1.5	36	17
	1JM-0714ES	-07 7/16-20	-14 M14x1.5	39	17
	1JM-0716ES	-07 7/16-20	-16 M16x1.5	36	22
	1JM-0910ES	-09 9/16-18	-10 M10x1.0	31	17
	1JM-0912ES	-09 9/16-18	-12 M12x1.5	36	17
	1JM-0914ES	-09 9/16-18	-14 M14x1.5	36	19
	1JM-0916ES	-09 9/16-18	-16 M16x1.5	36	22
	1JM-0918ES	-09 9/16-18	-18 M18x1.5	37	24
	1JM-0920ES	-09 9/16-18	-20 M20x1.5	40	27
	1JM-0922ES	-09 9/16-18	-22 M22x1.5	40	27
	1JM-1212ES	-12 3/4-16	-12 M12x1.5	39	22
	1JM-1214ES	-12 3/4-16	-14 M14x1.5	39	22
	1JM-1216ES	-12 3/4-16	-16 M16x1.5	39	22
	1JM-1218ES	-12 3/4-16	-18 M18x1.5	39	24
	1JM-1220ES	-12 3/4-16	-20 M20x1.5	43	27
	1JM-1222ES	-12 3/4-16	-22 M22x1.5	43	27
	1JM-1226ES	-12 3/4-16	-26 M26x1.5	47	32
	1JM-1414ES	-14 7/8-14	-14 M14x1.5	41	24
	1JM-1416ES	-14 7/8-14	-16 M16x1.5	41	24
	1JM-1418ES	-14 7/8-14	-18 M18x1.5	42	24
	1JM-1420ES	-14 7/8-14	-20 M20x1.5	45	27
	1JM-1422ES	-14 7/8-14	-22 M22x1.5	45	27
	1JM-1426ES	-14 7/8-14	-26 M26x1.5	49	32
	1JM-1718ES	-17 1.1/16-12	-18 M18x1.5	45	30
	1JM-1720ES	-17 1.1/16-12	-20 M20x1.5	46	30
	1JM-1722ES	-17 1.1/16-12	-22 M22x1.5	49	30
	1JM-1724	-17 1.1/16-12	-24 M24x1.5	49	30
	1JM-1726ES	-17 1.1/16-12	-26 M26x1.5	52	32
	1JM-1727	-17 1.1/16-12	-27 M27x2.0	52	32
	1JM-1727ES	-17 1.1/16-12	-27 M27x2.0	52	32
	1JM-1728	-17 1.1/16-12	-28 M28x1.5	52	32
	1JM-1730	-17 1.1/16-12	-30 M30x2.0	52	32
	1JM-1733ES	-17 1.1/16-12	-33 M33x2.0	52	38
	1JM-2126ES	-21 1.5/16-12	-26 M26x1.5	53	36
	1JM-2127ES	-21 1.5/16-12	-27 M27x2.0	53	36
	1JM-2133ES	-21 1.5/16-12	-33 M33x2.0	55	41
	1JM-2142ES	-21 1.5/16-12	-42 M42x2.0	57	50
	1JM-2642ES	-26 1.5/8-12	-42 M42x2.0	58	50
	1JM-3048ES	-30 1.7/8-12	-48 M48x2.0	65	55

1JN
JIC Male x NPT Male

SAE Specification

	Item No	A-JIC	B-NPT	L	H1
	1JN-0602	-06 3/8-24	-02 1/8-27	29	11.1
	1JN-0604	-06 3/8-24	-04 1/4-18	34	15.9
	1JN-0702	-07 7/16-20	-02 1/8-27	31	12.7
	1JN-0702-E46	-07 7/16-20	-02 1/8-27	46	12.7
	1JN-0702-E65	-07 7/16-20	-02 1/8-27	65	12.7
	1JN-0704	-07 7/16-20	-04 1/4-18	36	15.9
	1JN-0704-E48	-07 7/16-20	-04 1/4-18	48	15.9
	1JN-0704-E76	-07 7/16-20	-04 1/4-18	76	15.9
	1JN-0706	-07 7/16-20	-06 3/8-18	36	20.6
	1JN-0708	-07 7/16-20	-08 1/2-14	43	22.2
	1JN-0712	-07 7/16-20	-12 3/4-14	43	28.6
	1JN-0802	-08 1/2-20	-02 1/8-27	31	14.3
	1JN-0804	-08 1/2-20	-04 1/4-18	36	15.9
	1JN-0806	-08 1/2-20	-06 3/8-18	36	20.6
	1JN-0902	-09 9/16-18	-02 1/8-27	32	15.9
	1JN-0904	-09 9/16-18	-04 1/4-18	36	15.9
	1JN-0906	-09 9/16-18	-06 3/8-18	36	20.6
	1JN-0908	-09 9/16-18	-08 1/2-14	43	22.2
	1JN-0912	-09 9/16-18	-12 3/4-14	45	28.6
	1JN-1204	-12 3/4-16	-04 1/4-18	39	20.6
	1JN-1206	-12 3/4-16	-06 3/8-18	39	20.6
	1JN-1208	-12 3/4-16	-08 1/2-14	46	23.8
	1JN-1212	-12 3/4-16	-12 3/4-14	47	28.6
	1JN-1216	-12 3/4-16	-16 1-11.5	52	34.9
	1JN-1406	-14 7/8-14	-06 3/8-18	43	23.8
	1JN-1408	-14 7/8-14	-08 1/2-14	48	23.8
	1JN-1412	-14 7/8-14	-12 3/4-14	50	28.6
	1JN-1416	-14 7/8-14	-16 1-11.5	55	34.9
	1JN-1706	-17 1.1/16-12	-06 3/8-18	48	28.6
	1JN-1708	-17 1.1/16-12	-08 1/2-14	52	28.6
	1JN-1712	-17 1.1/16-12	-12 3/4-14	52	28.6
	1JN-1716	-17 1.1/16-12	-16 1-11.5	57	34.9
	1JN-1720	-17 1.1/16-12	-20 1.1/4-11.5	60	42.9
	1JN-1724	-17 1.1/16-12	-24 1.1/2-11.5	63	50.8
	1JN-2108	-21 1.5/16-12	-08 1/2-14	54	34.9
	1JN-2112	-21 1.5/16-12	-12 3/4-14	54	34.9
	1JN-2116	-21 1.5/16-12	-16 1-11.5	58	34.9
	1JN-2120	-21 1.5/16-12	-20 1.1/4-11.5	61	42.9
	1JN-2124	-21 1.5/16-12	-24 1.1/2-11.5	64	50.8
	1JN-2612	-26 1.5/8-12	-12 3/4-14	57	42.9
1JN-2616	-26 1.5/8-12	-16 1-11.5	62	42.9	
1JN-2620	-26 1.5/8-12	-20 1.1/4-11.5	62	42.9	
1JN-2624	-26 1.5/8-12	-24 1.1/2-11.5	65	50.8	
1JN-2632	-26 1.5/8-12	-32 2-11.5	71	66.7	
1JN-3016	-30 1.7/8-12	-16 1-11.5	66	50.8	
1JN-3020	-30 1.7/8-12	-20 1.1/4-11.5	67	50.8	
1JN-3024	-30 1.7/8-12	-24 1.1/2-11.5	68	50.8	
1JN-3032	-30 1.7/8-12	-32 2-11.5	73	66.7	
1JN-4016	-40 2.1/2-12	-16 1-11.5	77	66.7	
1JN-4020	-40 2.1/2-12	-20 1.1/4-11.5	78	66.7	
1JN-4024	-40 2.1/2-12	-24 1.1/2-11.5	78	66.7	
1JN-4032	-40 2.1/2-12	-32 2-11.5	79	66.7	
1JN-4040	-40 2.1/2-12	-32 2.1/2-11.5	86	82.6	

1JO
JIC Male x UNO Male

SAE Specification

	Item No	A-JIC	B-UNO	L	H1
	1JO-0606	-06 3/8-24	-06 3/8-24	28	12.7
	1JO-0607	-06 3/8-24	-07 7/16-20	29	14.3
	1JO-0707	-07 7/16-20	-07 7/16-20	29	14.3
	1JO-0708	-07 7/16-20	-08 1/2-20	29	15.9
	1JO-0709	-07 7/16-20	-09 9/16-18	30	17.5
	1JO-0712	-07 7/16-20	-12 3/4-16	33	22.2
	1JO-0714	-07 7/16-20	-14 7/8-14	38	25.4
	1JO-0717	-07 7/16-20	-17 1.1/16-12	42	31.8
	1JO-0721	-07 7/16-20	-21 1.5/16-12	43	38.1
	1JO-0807	-08 1/2-20	-07 7/16-20	31	14.3
1JO-0808	-08 1/2-20	-08 1/2-20	31	15.9	
1JO-0809	-08 1/2-20	-09 9/16-18	33	17.5	
1JO-0812	-08 1/2-20	-12 3/4-16	35	22.2	
1JO-0907	-09 9/16-18	-07 7/16-20	32	17.5	
1JO-0908	-09 9/16-18	-08 1/2-20	32	17.5	
1JO-0909	-09 9/16-18	-09 9/16-18	33	17.5	
1JO-0912	-09 9/16-18	-12 3/4-16	35	22.2	
1JO-0914	-09 9/16-18	-14 7/8-14	38	25.4	
1JO-0917	-09 9/16-18	-17 1.1/16-12	42	31.8	
1JO-0921	-09 9/16-18	-21 1.5/16-12	43	38.1	
1JO-1207	-12 3/4-16	-07 7/16-20	38	22.2	
1JO-1208	-12 3/4-16	-08 1/2-20	38	22.2	
1JO-1209	-12 3/4-16	-09 9/16-18	37	22.2	
1JO-1212	-12 3/4-16	-12 3/4-16	38	22.2	
1JO-1214	-12 3/4-16	-14 7/8-14	41	25.4	
1JO-1217	-12 3/4-16	-17 1.1/16-12	45	31.8	
1JO-1221	-12 3/4-16	-21 1.5/16-12	45	38.1	
1JO-1409	-14 7/8-14	-09 9/16-18	43	25.4	
1JO-1412	-14 7/8-14	-12 3/4-16	42	25.4	
1JO-1414	-14 7/8-14	-14 7/8-14	43	25.4	
1JO-1417	-14 7/8-14	-17 1.1/16-12	47	31.8	
1JO-1421	-14 7/8-14	-21 1.5/16-12	48	38.1	
1JO-1426	-14 7/8-14	-26 1.5/8-12	50	47.6	
1JO-1709	-17 1.1/16-12	-09 9/16-18	47	31.8	
1JO-1712	-17 1.1/16-12	-12 3/4-16	49	31.8	
1JO-1714	-17 1.1/16-12	-14 7/8-14	49	31.8	
1JO-1717	-17 1.1/16-12	-17 1.1/16-12	50	31.8	
1JO-1719	-17 1.1/16-12	-19 1.3/16-12	50	34.9	
1JO-1721	-17 1.1/16-12	-21 1.5/16-12	51	38.1	
1JO-1726	-17 1.1/16-12	-26 1.5/8-12	53	47.6	
1JO-1730	-17 1.1/16-12	-30 1.7/8-12	55	54.0	
1JO-1917	-19 1.3/16-12	-17 1.1/16-12	51	31.8	
1JO-1919	-19 1.3/16-12	-19 1.3/16-12	51	34.9	
1JO-1921	-19 1.3/16-12	-21 1.5/16-12	51	38.1	
1JO-2112	-21 1.5/16-12	-12 3/4-16	51	34.9	
1JO-2114	-21 1.5/16-12	-14 7/8-14	52	34.9	
1JO-2117	-21 1.5/16-12	-17 1.1/16-12	52	34.9	
1JO-2119	-21 1.5/16-12	-19 1.3/16-12	52	34.9	
1JO-2121	-21 1.5/16-12	-21 1.5/16-12	52	38.1	
1JO-2126	-21 1.5/16-12	-26 1.5/8-12	54	47.6	
1JO-2130	-21 1.5/16-12	-30 1.7/8-12	56	54.0	
1JO-2614	-26 1.5/8-12	-14 7/8-14	57	42.9	
1JO-2617	-26 1.5/8-12	-17 1.1/16-12	58	42.9	
1JO-2621	-26 1.5/8-12	-21 1.5/16-12	58	42.9	
1JO-2626	-26 1.5/8-12	-26 1.5/8-12	58	47.6	
1JO-2630	-26 1.5/8-12	-30 1.7/8-12	58	54.0	
1JO-3026	-30 1.7/8-12	-26 1.5/8-12	60	54.0	
1JO-3030	-30 1.7-8-12	-30 1.7/8-12	60	54.0	
1JO-3040	-40 2.1/2-12	-40 2.1/2-12	64	69.9	
1JO-4040	-40 2.1/2-12	-40 2.1/2-12	71	69.9	

1JOL
JIC Male x UNO Male Extended

SAE Specification

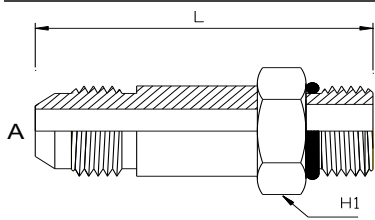

Item No	A-JIC	B-UNO	L	H1
1JOL-0707	-07 7/16-20	-07 7/16-20	53	14.3
1JOL-0909	-09 9/16-18	-09 9/16-18	59	17.5
1JOL-0912	-09 9/16-18	-12 3/4-16	66	22.2
1JOL-1212	-12 3/4-16	-12 3/4-16	69	22.2
1JOL-1214	-12 3/4-16	-14 7/8-14	75	25.4
1JOL-1414	-14 7/8-14	-14 7/8-14	77	25.4
1JOL-1714	-17 1.1/16-12	-14 7/8-14	89	31.8
1JOL-1717	-17 1.1/16-12	-17 1.1/16-12	92	31.8
1JOL-2121	-21 1.5/16-12	-21 1.5/16-12	101	38.1
1JOL-2626	-26 1.5/8-12	-26 1.5/8-12	119	47.6
1JOL-3030	-30 1.7/8-12	-30 1.7/8-12	131	54.0

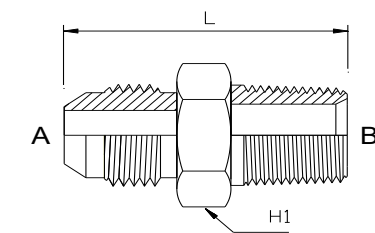
1JT
JIC Male x BSPT Male

Item No	A-JIC	B-BSPT	L	H1
1JT-0602	-06 3/8-24	-02 1/8-28	28	12
1JT-0701	-07 7/16-20	-01 1/16-28	30	12
1JT-0702	-07 7/16-20	-02 1/8-28	30	12
1JT-0702-E46	-07 7/16-20	-02 1/8-28	46	12
1JT-0702-E65	-07 7/16-20	-02 1/8-28	65	12
1JT-0704	-07 7/16-20	-04 1/4-19	35	14
1JT-0704-E46	-07 7/16-20	-04 1/4-19	46	14
1JT-0704-E57	-07 7/16-20	-04 1/4-19	57	14
1JT-0704-E76	-07 7/16-20	-04 1/4-19	76	14
1JT-0706	-07 7/16-20	-06 3/8-19	35	17
1JT-0708	-07 7/16-20	-08 1/2-14	41	22
1JT-0802	-08 1/2-20	-02 1/8-28	31	14
1JT-0804	-08 1/2-20	-04 1/4-19	34	14
1JT-0806	-08 1/2-20	-06 3/8-19	35	19
1JT-0902	-09 9/16-18	-02 1/8-28	31	17
1JT-0904	-09 9/16-18	-04 1/4-19	34	17
1JT-0906	-09 9/16-18	-06 3/8-19	34	17
1JT-0908	-09 9/16-18	-08 1/2-14	41	22
1JT-0912	-09 9/16-18	-12 3/4-14	44	30
1JT-1204	-12 3/4-16	-04 1/4-19	39	22
1JT-1206	-12 3/4-16	-06 3/8-19	39	22
1JT-1208	-12 3/4-16	-08 1/2-14	45	22
1JT-1212	-12 3/4-16	-12 3/4-14	46	30
1JT-1216	-12 3/4-16	-16 1-11	46	36
1JT-1404	-14 7/8-14	-04 1/4-19	42	24
1JT-1406	-14 7/8-14	-06 3/8-19	43	24
1JT-1408	-14 7/8-14	-08 1/2-14	47	24
1JT-1412	-14 7/8-14	-12 3/4-14	49	30
1JT-1416	-14 7/8-14	-16 1-11	55	36
1JT-1706	-17 1.1/16-12	-06 3/8-19	46	30
1JT-1708	-17 1.1/16-12	-08 1/2-14	51	30
1JT-1712	-17 1.1/16-12	-12 3/4-14	51	30
1JT-1716	-17 1.1/16-12	-16 1-11	58	36
1JT-1720	-17 1.1/16-12	-20 1.1/4-11	60	46
1JT-1724	-17 1.1/16-12	-24 1.1/2-11	63	50
1JT-1912	-19 1.3/16-12	-12 3/4-14	53	32
1JT-1916	-19 1.3/16-12	-16 1-11	58	36
1JT-2108	-21 1.5/16-12	-08 1/2-14	53	36
1JT-2112	-21 1.5/16-12	-12 3/4-14	53	36
1JT-2116	-21 1.5/16-12	-16 1-11	59	36
1JT-2120	-21 1.5/16-12	-20 1.1/4-11	62	46
1JT-2124	-21 1.5/16-12	-24 1.1/2-11	65	50
1JT-2616	-26 1.5/8-12	-16 1-11	63	46
1JT-2620	-26 1.5/8-12	-20 1.1/4-11	63	46
1JT-2624	-26 1.5/8-12	-24 1.1/2-11	67	50
1JT-2632	-26 1.5/8-12	-32 2-11	72	65
1JT-3020	-30 1.7/8-12	-20 1.1/4-11	68	50
1JT-3024	-30 1.7/8-12	-24 1.1/2-11	70	50
1JT-3032	-30 1.7/8-12	-32 2-11	75	65
1JT-4024	-40 2.1/2-12	-24 1.1/2-11	77	65
1JT-4032	-40 2.1/2-12	-32 2-11	80	65

1K
JIS Metric Male x JIS Metric Male (Komatsu)

Item No	A-JIS	B-JIS	L	H1
1K-1414	-14 M14x1.5	-14 M14x1.5	40	17
1K-1616	-16 M16x1.5	-16 M16x1.5	43	19
1K-1818	-18 M18x1.5	-18 M18x1.5	43	22
1K-2020	-20 M20x1.5	-20 M20x1.5	48	22
1K-2222	-22 M22x1.5	-22 M22x1.5	48	24
1K-2424	-24 M24x1.5	-24 M24x1.5	52	27
1K-3030	-30 M30x1.5	-30 M30x1.5	63	32
1K-3333	-33 M33x1.5	-33 M33x1.5	72	36
1K-3636	-36 M36x1.5	-36 M36x1.5	79	41
1K-4242	-42 M42x1.5	-42 M42x1.5	87	46

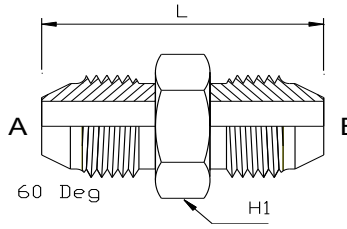

1KT
JIS Metric Male (Komatsu) x BSPT Male

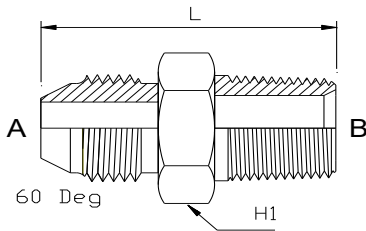
Item No	A-JIC	B-BSPT	L	H1
1KT-1204	-12 M12x1.5	-04 1/4-19	37	14
1KT-1404	-14 M14x1.5	-04 1/4-19	38	17
1KT-1406	-14 M14x1.5	-06 3/8-19	38	17
1KT-1606	-16 M16x1.5	-06 3/8-19	39	19
1KT-1806	-18 M18x1.5	-06 3/8-19	41	19
1KT-1808	-18 M18x1.5	-08 1/2-14	46	24
1KT-2006	-20 M20x1.5	-06 3/8-19	43	22
1KT-2008	-20 M20x1.5	-08 1/2-14	47	24
1KT-2206	-22 M22x1.5	-06 3/8-19	42	24
1KT-2208	-22 M22x1.5	-08 1/2-14	48	24
1KT-2408	-24 M24x1.5	-08 1/2-14	51	32
1KT-2412	-24 M24x1.5	-12 3/4-14	54	32
1KT-3012	-30 M30x1.5	-12 3/4-14	57	32
1KT-3316	-33 M33x1.5	-16 1-11	66	36

1N
NPT Male x NPT Male

SAE Specification

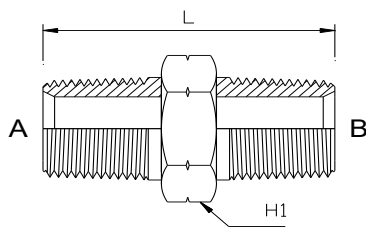
Item No	A-NPT	B-NPT	L	H1
1N-0202	-02 1/8-27	-02 1/8-27	27	11.1
1N-0402	-04 1/4-18	-02 1/8-27	32	14.3
1N-0404	-04 1/4-18	-04 1/4-18	37	15.9
1N-0602	-06 3/8-18	-02 1/8-27	32	19.1
1N-0604	-06 3/8-18	-04 1/4-18	37	19.1
1N-0606	-06 3/8-18	-06 3/8-18	37	19.1
1N-0804	-08 1/2-14	-04 1/4-18	43	22.2
1N-0806	-08 1/2-14	-06 3/8-18	43	22.2
1N-0808	-08 1/2-14	-08 1/2-14	48	22.2
1N-1204	-12 3/4-14	-04 1/4-18	45	28.6
1N-1206	-12 3/4-14	-06 3/8-18	45	28.6
1N-1208	-12 3/4-14	-08 1/2-14	50	28.6
1N-1212	-12 3/4-14	-12 3/4-14	50	28.6
1N-1606	-16 1-11.5	-06 3/8-18	50	34.9
1N-1608	-16 1-11.5	-08 1/2-14	55	34.9
1N-1612	-16 1-11.5	-12 3/4-14	55	34.9
1N-1616	-16 1-11.5	-16 1-11.5	59	34.9
1N-2012	-20 1.1/4-11.5	-12 3/4-14	61	44.5
1N-2016	-20 1.1/4-11.5	-16 1-11.5	62	44.5
1N-2020	-20 1.1/4-11.5	-20 1.1/4-11.5	63	44.5
1N-2412	-24 1.1/2-11.5	-12 3/4-14	60	50.8
1N-2416	-24 1.1/2-11.5	-16 1-11.5	65	50.8
1N-2420	-24 1.1/2-11.5	-20 1.1/4-11.5	66	50.8
1N-2424	-24 1.1/2-11.5	-24 1.1/2-11.5	66	50.8
1N-3216	-32 2-11.5	-16 1-11.5	69	63.5
1N-3220	-32 2-11.5	-20 1.1/4-11.5	70	63.5
1N-3224	-32 2-11.5	-24 1.1/2-11.5	71	63.5
1N-3232	-32 2-11.5	-32 2-11.5	72	63.5

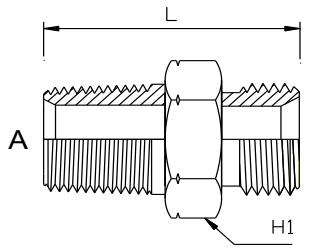

1NB
NPT Male x BSPP Male

Item No	A-NPT	B-BSPP	L	H1
1NB-0202	-02 1/8-28	-02 1/8-27	25	14
1NB-0404	-04 1/4-18	-04 1/4-19	35	19
1NB-0606	-06 3/8-18	-06 3/8-19	35	22
1NB-0608	-06 3/8-18	-08 1/2-14	38	27
1NB-0806	-08 1/2-14	-06 3/8-18	38	27
1NB-0808	-08 1/2-14	-08 1/2-14	43	27
1NB-0812	-08 1/2-14	-12 3/4-14	44	32
1NB-1208	-12 3/4-14	-08 1/2-14	44	32
1NB-1212	-12 3/4-14	-12 3/4-14	49	32
1NB-1616	-16 1-11.5	-16 1-11	59	41
1NB-2020	-20 1.1/4-11.5	-20 1.1/4-11	59	46
1NB-2424	-24 1.1/2-11.5	-24 1.1/2-11	62	55
1NB-2432	-24 1.1/2-11.5	-32 2-11	72	70
1NB-3232	-32 2-11.5	-32 2-11	74	70

- BSPP end can be fitted with O-ring+Retaining Ring if required. Page 115

1NO
NPT Male x UNO Male

SAE Specification

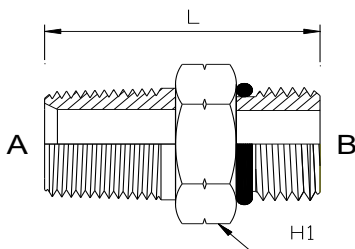

Item No	A-NPT	B-UNO	L	H1
1NO-0207	-02 1/8-27	-07 7/16-20	27	14.3
1NO-0407	-04 1/4-19	-07 7/16-20	32	14.2
1NO-0408	-04 1/4-19	-08 1/2-20	32	15.9
1NO-0409	-04 1/4-19	-09 9/16-18	34	20.6
1NO-0412	-04 1/4-19	-12 3/4-16	37	27.0
1NO-0414	-04 1/4-19	-14 7/8-14	39	28.6
1NO-0607	-06 3/8-19	-07 7/16-20	33	19.1
1NO-0609	-06 3/8-19	-09 9/16-18	34	20.6
1NO-0612	-06 3/8-19	-12 3/4-16	37	27.0
1NO-0614	-06 3/8-19	-14 7/8-14	39	28.6
1NO-0617	-06 3/8-19	-17 1.1/16-12	42	31.8
1NO-0807	-08 1/2-14	-07 7/16-20	42	22.2
1NO-0809	-08 1/2-14	-09 9/16-18	41	22.2
1NO-0812	-08 1/2-14	-12 3/4-16	40	22.2
1NO-0814	-08 1/2-14	-14 7/8-14	43	25.4
1NO-0817	-08 1/2-14	-17 1.1/16-12	47	31.8
1NO-1212	-12 3/4-14	-12 3/4-16	45	28.6
1NO-1214	-12 3/4-14	-14 7/8-14	43	28.6
1NO-1217	-12 3/4-14	-17 1.1/16-12	47	31.8
1NO-1219	-12 3/4-14	-19 1.3/16-12	47	34.9
1NO-1221	-12 3/4-14	-21 1.5/16-12	48	38.1
1NO-1617	-16 1-11.5	-17 1.1/16-12	52	34.9
1NO-1621	-16 1-11.5	-21 1.5/16-12	53	38.1
1NO-1626	-16 1-11.5	-26 1.5/8-12	55	47.6
1NO-2021	-20 1.1/4-11.5	-21 1.5/16-12	58	42.9
1NO-2026	-20 1.1/4-11.5	-26 1.5/8-12	56	47.6
1NO-2430	-24 1.1/2-11.5	-30 1.7/8-12	58	69.9

10
UNO Male x UNO Adjustable Male

SAE Specification

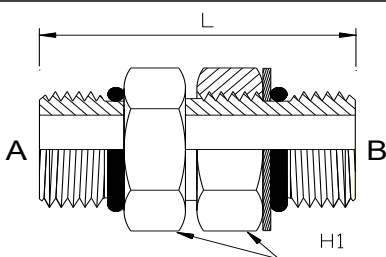

Item No	A-UNO	B-UNO	L	H1
10-0909	-09 9/16-18	-09 9/16-18	40	17.5
10-1212	-12 3/4-16	-12 3/4-16	40	22.2
10-1414	-14 7/8-14	-14 7/8-14	52	25.4

1P
SAE 45 Deg Male x SAE 45 Deg Male

SAE Specification

Item No	A-SAE	B-SAE	L	H1
1P-1010	-10 5/8-18	-10 5/8-18	38	17

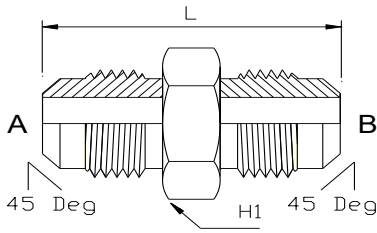
1JPI
JIC Male x SAE Inverted Flare Male

Item No	A-JIC	B-SIF	L	H1
1JPI-0706	-07 7/16-20	-06 3/8-24		
1JPI-0707	-07 7/16-20	-07 7/16-24		
1JPI-0808	-08 1/2-20	-08 1/2-20		
1JPI-0908	-09 9/16-18	-08 1/2-20		
1JPI-0910	-09 9/16-18	-10 5/8-18		
1JPI-1210	-12 3/4-16	-10 5/8-18		
1JPI-1211	-12 3/4-16	-11 11/16-18		
1JPI-1212	-12 3/4-16	-12 3/4-18		

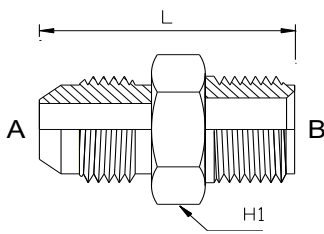

For 5/8 SAE (45 Deg) Male x SAE Inverted Flare Male see 1PPI - Page 18

1PPI
SAE 45 Deg Male x SAE Inverted Flare Male

Item No	A-SAE	B-SIF	L	H1
1PPI-1008	-10 5/8-18	-08 1/2-20	32	17.5
1PPI-1010	-10 5/8-18	-10 5/8-18	33	17.5

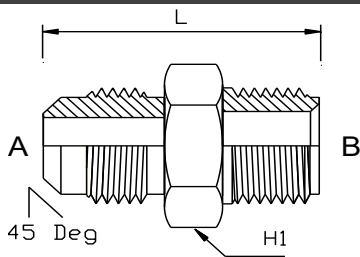
1PT
SAE 45 Deg Male x BSPT Male

Item No	A-SAE	B-BSPT	L	H1
1PT-1004	-10 5/8-18	-04 1/4-19	36	17
1PT-1006	-10 5/8-18	-06 3/8-19	35	17
1PT-1008	-10 5/8-18	-08 1/2-14	41	22

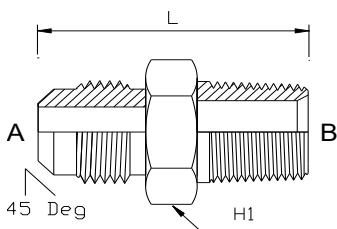

1S
JIS (BSP) Male x JIS (BSP) Male

	Item No	A-JIS	B-JIS	L	H1
	1S-0404	-04 1/4-19	-04 1/4-19	39	17
	1S-0606	-06 3/8-19	-06 3/8-19	44	19
	1S-0808	-08 1/2-14	-08 1/2-14	50	22
	1S-1212	-12 3/4-12	-12 3/4-14	56	30
	1S-1616	-16 1-11	-16 1-11	60	36

1ST
JIS (BSP) Male x BSPT Male

	Item No	A-JIS	B-BSPT	L	H1
	1ST-0404	-04 1/4-19	-04 1/4-19	38	17
	1ST-0606	-06 3/8-19	-06 3/8-19	41	19
	1ST-0808	-08 1/2-14	-08 1/2-14	49	22
	1ST-1212	-12 3/4-12	-12 3/4-14	54	30
	1ST-1616	-16 1-11	-16 1-11	64	36

1T
BSPT Male x BSPT Male

	Item No	A-BSPT	B-BSPT	L	H1
	1T-0202	-02 1/8-28	-02 1/8-28	26	12
	1T-0402	-04 1/4-19	-02 1/8-28	31	14
	1T-0404	-04 1/4-19	-04 1/4-19	34	14
	1T-0602	-06 3/8-19	-02 1/8-28	31	17
	1T-0604	-06 3/8-19	-04 1/4-19	15	17
	1T-0606	-06 3/8-19	-06 3/8-19	36	17
	1T-0804	-08 1/2-14	-04 1/4-19	43	22
	1T-0806	-08 1/2-14	-06 3/8-19	43	22
	1T-0808	-08 1/2-14	-08 1/2-14	46	22
	1T-1008	-10 5/8-14	-08 1/2-14	46	24
	1T-1010	-10 5/8-14	-10 5/8-14	46	24
	1T-1204	-12 3/4-14	-04 1/4-19	45	30
	1T-1206	-12 3/4-14	-06 3/8-19	46	30
	1T-1208	-12 3/4-14	-08 1/2-14	48	30
	1T-1210	-12 3/4-14	-10 5/8-14	48	30
	1T-1212	-12 3/4-14	-12 3/4-14	48	30
	1T-1606	-16 1-11	-06 3/8-19	52	30
	1T-1608	-16 1-11	-08 1/2-14	57	36
	1T-1612	-16 1-11	-12 3/4-14	56	36
	1T-1616	-16 1-11	-16 1-11	61	36
	1T-2012	-20 1.1/4-11	-12 3/4-14	59	46
	1T-2016	-20 1.1/4-11	-16 1-11	65	46
	1T-2020	-20 1.1/4-11	-20 1.1/4-11	66	46
	1T-2412	-24 1.1/2-11	-12 3/4-14	50	50
	1T-2416	-24 1.1/2-11	-16 1-11	66	50
	1T-2420	-24 1.1/2-11	-20 1.1/4-11	67	50
	1T-2424	-24 1.1/2-11	-24 1.1/2-11	67	50
	1T-3220	-32 2-11	-20 1.1/4-11	67	50
	1T-3224	-32 2-11	-24 1.1/2-11	72	65
	1T-3232	-32 2-11	-32 2-11	75	65
	1T-4032	-40 2.1/2-11	-32 2-11	80	80
	1T-4040	-40 2.1/2-11	-40 2.1/2-11	83	80
	1T-4848	-48 3-11	-48 3-11	95	100

1TG
BSPT Male x BSPP Male

Encapsulated Seal Type

	Item No	A-BSPT	B-BSPP	L	H1
	1TG-0202	-02 1/8-28	-02 1/8-28	25	14
	1TG-0204	-02 1/8-28	-04 1/4-19	30	19
	1TG-0402	-04 1/4-19	-02 1/8-28	30	14
	1TG-0404	-04 1/4-19	-04 1/4-19	36	19
	1TG-0406	-04 1/4-19	-06 3/8-19	37	22
	1TG-0408	-04 1/4-19	-08 1/2-14	42	27
	1TG-0604	-06 3/8-19	-04 1/4-19	37	22
	1TG-0606	-06 3/8-19	-06 3/8-19	37	22
	1TG-0608	-06 3/8-19	-08 1/2-14	42	27
	1TG-0612	-06 3/8-19	-12 3/4-14	45	32
	1TG-0804	-08 1/2-14	-04 1/4-19	43	27
	1TG-0806	-08 1/2-14	-06 3/8-19	44	27
	1TG-0808	-08 1/2-14	-08 1/2-14	47	27
	1TG-0812	-08 1/2-14	-12 3/4-14	47	32
	1TG-0816	-08 1/2-14	-16 1-11	54	41
	1TG-1206	-12 3/4-14	-06 3/8-19	45	30
	1TG-1208	-12 3/4-14	-08 1/2-14	47	32
	1TG-1212	-12 3/4-14	-12 3/4-14	47	32
	1TG-1216	-12 3/4-14	-16 1-11	52	41
	1TG-1220	-12 3/4-14	-20 1.1/4-11	57	50
	1TG-1608	-16 1-11	-08 1/2-14	53	36
	1TG-1612	-16 1-11	-12 3/4-14	51	41
	1TG-1616	-16 1-11	-16 1-11	55	41
	1TG-1620	-16 1-11	-20 1.1/4-11	56	50
	1TG-1624	-16 1-11	-24 1.1/2-11	67	55
	1TG-2012	-20 1.1/4-11	-12 3/4-14	59	46
	1TG-2016	-20 1.1/4-11	-16 1-11	61	46
	1TG-2020	-20 1.1/4-11	-20 1.1/4-11	59	50
	1TG-2024	-20 1.1/4-11	-24 1.1/2-11	67	55
	1TG-2420	-24 1.1/2-11	-20 1.1/4-11	65	55
	1TG-2424	-24 1.1/2-11	-24 1.1/2-11	59	55
	1TG-3232	-32 2-11	-32 2-11	64	75

* For O-Ring + Retaining Ring type see next page

1TG*R
BSPT Male x BSPP Male

O-Ring + Retaining Ring Type

	Item No	A-BSPT	B-BSPP	L	H1
	1TG-0402R	-04 1/4-19	-02 1/8-28	30	14
	1TG-0404R	-04 1/4-19	-04 1/4-19	36	19
	1TG-0406R	-04 1/4-19	-06 3/8-19	37	22
	1TG-0408R	-04 1/4-19	-08 1/2-14	42	27
	1TG-0604R	-06 3/8-19	-04 1/4-19	37	22
	1TG-0606R	-06 3/8-19	-06 3/8-19	37	22
	1TG-0608R	-06 3/8-19	-08 1/2-14	42	27
	1TG-0804R	-08 1/2-14	-04 1/4-19	43	27
	1TG-0806R	-08 1/2-14	-06 3/8-19	44	27
	1TG-0808R	-08 1/2-14	-08 1/2-14	47	27
	1TG-0812R	-08 1/2-14	-12 3/4-14	47	32
	1TG-0816R	-08 1/2-14	-16 1-11	54	41
	1TG-1208R	-12 3/4-14	-08 1/2-14	47	32
	1TG-1212R	-12 3/4-14	-12 3/4-14	47	32
	1TG-1216R	-12 3/4-14	-16 1-11	52	41
	1TG-1220R	-12 3/4-14	-20 1.1/4-11	57	50
	1TG-1608R	-16 1-11	-08 1/2-14	53	36
	1TG-1612R	-16 1-11	-12 3/4-14	51	41
	1TG-1616R	-16 1-11	-16 1-11	55	41
	1TG-1620R	-16 1-11	-20 1.1/4-11	56	50
	1TG-2012R	-20 1.1/4-11	-12 3/4-14	59	46
	1TG-2016R	-20 1.1/4-11	-16 1-11	61	46
	1TG-2020R	-20 1.1/4-11	-20 1.1/4-11	59	50
	1TG-2024R	-20 1.1/4-11	-24 1.1/2-11	67	55
	1TG-2420R	-24 1.1/2-11	-20 1.1/4-11	65	55
	1TG-2424R	-24 1.1/2-11	-24 1.1/2-11	59	55
	1TG-3232R	-32 2-11	-32 2-11	64	75

1TM
BSPT Male x Metric Male

Encapsulated Seal Type

	Item No	A-BSPT	B-Metric	L	H1
	1TM-0210	-02 1/8-28	-10 M10x1.0	26	14
	1TM-0412	-04 1/4-19	-12 M12x1.5	37	17
	1TM-0414	-04 1/4-19	-14 M14x1.5	37	19
	1TM-0416	-04 1/4-19	-16 M16x1.5	37	22
	1TM-0616	-06 3/8-19	-16 M16x1.5	37	22
	1TM-0618	-06 3/8-19	-18 M18x1.5	38	24
	1TM-0620	-06 3/8-19	-20 M20x1.5	41	27
	1TM-0816	-08 1/2-14	-16 M16x1.5	42	27
	1TM-0818	-08 1/2-14	-18 M18x1.5	42	27
	1TM-0822	-08 1/2-14	-22 M22x1.5	45	27
	1TM-0826	-08 1/2-14	-26 M26x1.5	49	32
	1TM-0827	-08 1/2-14	-27 M27x2.0	49	32
	1TM-1226	-12 3/4-14	-26 M26x1.5	50	32
	1TM-1227	-12 3/4-14	-27 M27x2.0	50	32

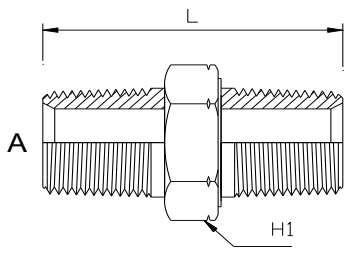
1TN
BSPT Male x NPT Male

Item No	A-BSPT	B-NPT	L	H1
1TN-0202	-02 1/8-28	-02 1/8-27	26	12
1TN-0404	-04 1/4-19	-04 1/4-18	38	16
1TN-0406	-04 1/4-19	-06 3/8-18	38	19
1TN-0604	-06 3/8-19	-04 1/4-18	38	19
1TN-0606	-06 3/8-19	-06 3/8-18	38	19
1TN-0808	-08 1/2-14	-08 1/2-14	47	22
1TN-1212	-12 3/4-12	-12 3/4-14	51	30
1TN-1616	-16 1-11	-16 1-11.5	62	38
1TN-2020	-20 1.1/4-11	-20 1.1/4-11.5	64	46
1TN-2424	-24 1.1/2-11	-24 1.1/2-11.5	67	50
1TN-2432	-24 1.1/2-11	-32 2-11.5	71	65
1TN-3232	-32 2-11	-32 2-11.5	75	65
1TN-4848	-48 3-11.5	-48 3-11.5	95	100

* Identifying "V" on the hex is offset, identifying the NPT end

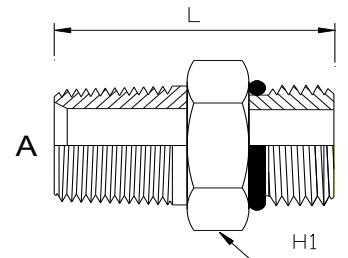
1TO
BSPT Male x UNO Male

Item No	A-BSPT	B-UNO	L	H1
1TO-0207	-02 1/8-28	-07 7/16-20	25	14
1TO-0407	-04 1/4-19	-07 7/16-20	30	16
1TO-0408	-04 1/4-19	-08 1/2-20	30	19
1TO-0409	-04 1/4-19	-09 9/16-18	31	19
1TO-0412	-04 1/4-19	-12 3/4-16	33	22
1TO-0414	-04 1/4-19	-14 7/8-14	37	27
1TO-0607	-06 3/8-19	-07 7/16-20	30	19
1TO-0609	-06 3/8-19	-09 9/16-18	31	19
1TO-0612	-06 3/8-19	-12 3/4-16	33	22
1TO-0614	-06 3/8-19	-14 7/8-14	37	27
1TO-0617	-06 3/8-19	-17 1.1/16-12	37	32
1TO-0809	-08 1/2-14	-09 9/16-18	37	22
1TO-0812	-08 1/2-14	-12 3/4-16	38	22
1TO-0814	-08 1/2-14	-14 7/8-14	43	27
1TO-0817	-08 1/2-14	-17 1.1/16-12	46	32
1TO-0821	-08 1/2-14	-21 1.5/16-12	46	38
1TO-1212	-12 3/4-14	-12 3/4-16	42	30
1TO-1214	-12 3/4-14	-14 7/8-14	44	32
1TO-1217	-12 3/4-14	-17 1.1/16-12	46	32
1TO-1221	-12 3/4-14	-21 1.5/16-12	47	38
1TO-1617	-16 1-11	-17 1.1/16-12	51	36
1TO-1621	-16 1-11	-21 1.5/16-12	51	38
1TO-1626	-16 1-11	-26 1.5/8-12	58	50
1TO-2021	-20 1.1/4-11	-21 1.5/16-12	57	50
1TO-2026	-20 1.1/4-11	-26 1.5/8-12	57	50
1TO-2030	-20 1.1/4-11	-30 1.7/8-12	59	55
1TO-2426	-24 1.1/2-11	-26 1.5/8-12	56	50
1TO-2430	-24 1.1/2-11	-30 1.7/8-12	59	55

STRAIGHT M x FS
Selection Guide - ORFS Expander * Reducer * Union

Straight Male / Female adaptors are available in different styles, One Piece (solid), Two Piece (nut and insert), Crimp Nut
 The selection chart below simplifies selection and availability. After identifying the item required, scroll down
 for more detailed information required for the item.

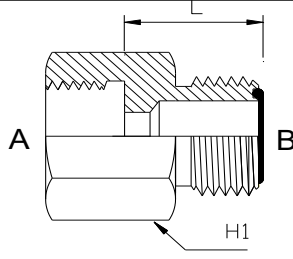
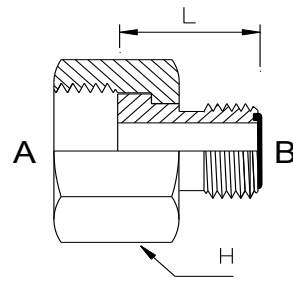
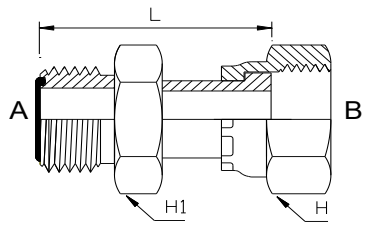
	Part Number Selection			Size	Size
	One Piece	Two Piece	Union	A	B
 <p>ONE PIECE</p>	2F1-0911		2F-0909	-09 9/16-18	-09 9/16-18
		2F2-1109		-09 9/16-18	-11 11/16-16
			2F-1111	-11 11/16-16	-11 11/16-16
	2F1-1113			-11 11/16-16	-13 13/16-16
		2F2-1309		-13 13/16-16	-09 9/16-18
		2F2-1311		-13 13/16-16	-11 11/16-16
			2F-1313	-13 13/16-16	-13 13/16-16
	2F1-1316			-13 13/16-16	-16 1-14
	2F1-1319			-13 13/16-16	-19 1.3/16-12
		2F2-1611		-16 1-14	-11 11/16-16
	2F2-1613		-16 1-14	-13 13/16-16	
		2F-1616	-16 1-14	-16 1-14	
	2F1-1619		-16 1-14	-19 1.3/16-12	
 <p>TWO PIECE</p>		2F2-1909		-19 1.3/16-12	-09 9/16-18
		2F2-1911		-19 1.3/16-12	-11 11/16-16
		2F2-1913		-19 1.3/16-12	-13 13/16-16
		2F2-1916		-19 1.3/16-12	-16 1-14
			2F-1919	-19 1.3/16-12	-19 1.3/16-12
		2F2-2313		-23 1.7/16-12	-13 13/16-16
		2F2-2316		-23 1.7/16-12	-16 1-14
		2F2-2319		-23 1.7/16-12	-19 1.3/16-12
			2F-2323	-23 1.7/16-12	-23 1.7/16-12
		2F2-2713		-27 1.11/16-12	-13 13/16-16
	2F2-2719		-27 1.11/16-12	-19 1.3/16-12	
	2F2-2723		-27 1.11/16-12	-23 1.7/16-12	
	2F2-3223		-32 2-12	-23 1.7/16-12	
	2F2-3227		-32 2-12	-27 1.11/16-12	
 <p>UNION</p>					

2F
ORFS Male x ORFS Female Union

Item No	A-ORFS	B-ORFS	L	H1	H
2F-0909	-09 9/16-18	-09 9/16-18	34	16	17.46
2F-1111	-11 11/16-16	-11 11/16-16	38	19	20.64
2F-1313	-13 13/16-16	-13 13/16-16	44	22	23.81
2F-1616	-16 1-14	-16 1-14	51	27	28.58
2F-1919	-19 1.3/16-12	-19 1.3/16-12	58	32	34.93
2F-2323	-23 1.7/16-12	-23 1.7/16-12	62	38	41.28

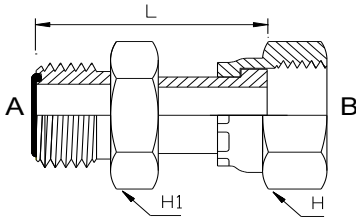

ORFS Male x Female selection guide - see Page..... 23

2F1
ORFS Female x ORFS Male Expander (One Piece)

Item No	A-ORFS	B-ORFS	L	H1
2F1-0911	-09 9/16-18	-11 11/16-16	25	19
2F1-1113	-11 11/16-16	-13 13/16-16	26	22
2F1-1316	-13 13/16-16	-16 1-14	31	27
2F1-1319	-13 13/16-16	-19 1.3/16-12	34	30
2F1-1619	-16 1-14	-19 1.3/16-12	35	30

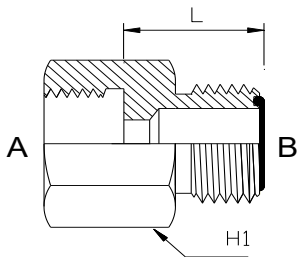

ORFS Male x Female selection guide - see Page..... 23

2F2
ORFS Female x ORFS Male Reducer (Nut + Insert)

Item No	A-ORFS	B-ORFS	L	H
2F2-1109	-11 11/16-16	-09 9/16-18	20	20.64
2F2-1309	-13 13/16-16	-09 9/16-18	22	23.81
2F2-1311	-13 13/16-16	-11 11/16-16	22	23.81
2F2-1609	-16 1-14	-09 9/16-18	24	28.58
2F2-1611	-16 1-14	-11 11/16-16	24	28.58
2F2-1613	-16 1-14	-13 13/16-16	26	28.58
2F2-1909	-19 1.3/16-12	-09 9/16-18	25	34.93
2F2-1911	-19 1.3/16-12	-11 11/16-16	26	34.93
2F2-1913	-19 1.3/16-12	-13 13/16-16	28	34.93
2F2-1916	-19 1.3/16-12	-16 1-14	29	34.93
2F2-2313	-23 1.7/16-12	-13 13/16-16	29	41.28
2F2-2316	-23 1.7/16-12	-16 1-14	32	41.28
2F2-2319	-23 1.7/16-12	-19 1.3/16-12	33	41.28
2F2-2713	-27 1.11/16-12	-13 13/16-16	34	47.63
2F2-2719	-27 1.11/16-12	-19 1.3/16-12	34	47.63
2F2-2723	-27 1.11/16-12	-23 1.7/16-12	38	47.63
2F2-3223	-32 2-12	-23 1.7/16-12	34	57.15
2F2-3227	-32 2-12	-27 1.11/16-12	34	57.15

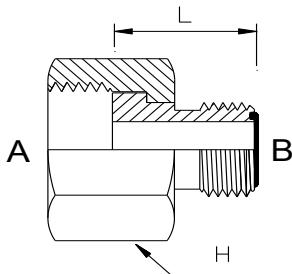

ORFS Male x Female selection guide - see Page..... 23

2F200
ORFS Tube Nut

Item No	A-ORFS	L	H
2F200-09	-09 9/16-18	15	17.46
2F200-11	-11 11/16-16	17	20.64
2F200-13	-13 13/16-16	21	23.81
2F200-16	-16 1-14	23	28.58
2F200-19	-19 1.3/16-12	26	34.93
2F200-23	-23 1.7/16-12	28	41.28
2F200-27	-27 1.11/16-12	28	47.63
2F200-32	-32 2-11	28	57.15

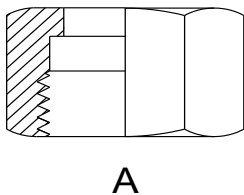

2FJ
ORFS Male x JIC Female Union

SAE Specification

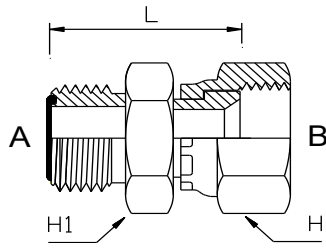

Item No	A-ORFS	B-JIC	L	H1	H
2FJ-0907	-09 9/16-18	-07 7/16-20	27	15.88	14.27
2FJ-1107	-11 11/16-16	-07 7/16-20	29	19.05	14.27
2FJ-1109	-11 11/16-16	-09 9/16-18	31	19.05	17.46
2FJ-1309	-13 13/16-16	-09 9/16-18	33	22.23	17.45
2FJ-1312	-13 13/16-16	-12 3/4-16	35	22.23	22.23
2FJ-1314	-13 13/16-16	-14 7/8-14	38	22.23	25.40
2FJ-1614	-16 1-14	-14 7/8-14	40	25.40	25.40
2FJ-1914	-19 1.3/16-12	-14 7/8-14	42	31.75	25.40
2FJ-1917	-19 1.3/16-12	-17 1.1/16-12	44	31.75	31.80
2FJ-2314	-23 1.7/16-12	-14 7/8-14	45	38.10	25.40
2FJ-2317	-23 1.7/16-12	-17 1.1/16-12	45	38.10	31.80
2FJ-2321	-23 1.7/16-12	-21 1.5/16-12	47	38.10	38.10
2FJ-2326	-23 1.7/16-12	-26 1.5/8-12	49	44.50	50.00
2FJ-2726	-27 1.11/16-12	-26 1.5/8-12	50	50.80	50.00

2GB
BSP Male x BSP Female Swivel Union

Encapsulated Seal

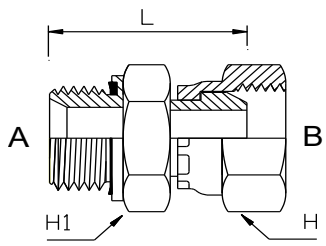

Item No	A-BSP	B-BSP	L	H1	H
2GB-0202	-02 1/8-28	-02 1/8-28	24	14	14
2GB-0404	-04 1/4-19	-04 1/4-19	30	19	19
2GB-0406	-04 1/4-19	-06 3/8-19	32	19	22
2GB-0408	-04 1/4-19	-08 1/2-14	35	22	27
2GB-0604	-06 3/8-19	-04 1/4-19	30	22	19
2GB-0606	-06 3/8-19	-06 3/8-19	35	22	22
2GB-0608	-06 3/8-19	-06 1/2-14	35	22	27
2GB-0806	-08 1/2-14	-06 3/8-19	39	27	22
2GB-0808	-08 1/2-14	-08 1/2-14	39	27	27
2GB-0812	-08 1/2-14	-12 3/4-14	40	27	32
2GB-1208	-12 3/4-14	-08 1/2-14	43	32	27
2GB-1212	-12 3/4-14	-12 3/4-14	44	32	32
2GB-1216	-12 3/4-14	-16 1-11	48	38	41 *
2GB-1612	-16 1-11	-12 3/4-14	45	41	32
2GB-1616	-16 1-11	-16 1-11	53	41	41 *
2GB-1620R	-16 1-11	-20 1.1/4-11	51	46	50 *
2GB-2020	-20 1.1/4-11	-20 1.1/4-11	52	50	50 *
2GB-2024	-20 1.1/4-11	-24 1.1/2-11	59	55	50 *
2GB-2420	-24 1.1/2-11	-20 1.1/4-11	60	55	50 *
2GB-2424	-24 1.1/2-11	-24 1.1/2-11	61	55	55 *
2GB-3232	-32 2-11	-32 2-11	69	70	70 *

Note - * denotes wire type nut.

2GB*R
BSP Male x BSP Female Swivel Union

O-Ring + Ret. Ring

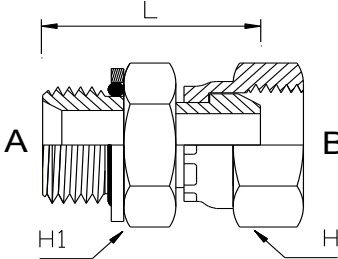

Item No	A-BSP	B-BSP	L	H1	H
2GB-0404R	-04 1/4-19	-04 1/4-19	31	19	19
2GB-0606R	-06 3/8-19	-06 3/8-19	31	22	22
2GB-0808R	-08 1/2-14	-08 1/2-14	37	27	27
2GB-1212R	-12 3/4-14	-12 3/4-14	40	32	32
2GB-1612R	-16 1-11	-12 3/4-14	44	41	32
2GB-1616R	-16 1-11	-16 1-11	53	41	38
2GB-1620R	-16 1-11	-20 1.1/4-12	51	46	50 *
2GB-2016R	-20 1.1/4-12	-16 1-11	51	50	41 *
2GB-2020R	-20 1.1/4-12	-20 1.1/4-12	52	50	50 *

Note - * denotes wire type nut.

2GF
BSP Male x ORFS Female Swivel Union

Encapsulated Seal

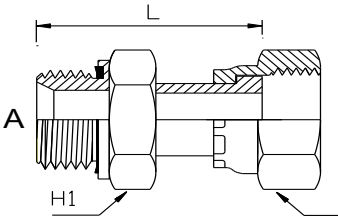

Item No	A-BSP	B-ORFS	L	H1	H
2GF-0409	-04 1/4-19	-09 9/16-18	38	19	17.46
2GF-0411	-04 1/4-19	-11 11/16-16	40	19	20.64
2GF-0609	-06 3/8-19	-09 9/16-18	38	22	17.46
2GF-0611	-06 3/8-19	-11 11/16-16	40	22	20.64
2GF-0613	-06 3/8-19	-13 13/16-16	44	22	23.81
2GF-0811	-08 1/2-14	-11 11/16-16	44	27	20.64
2GF-0813	-08 1/2-14	-13 13/16-16	48	27	23.81
2GF-0816	-08 1/2-14	-16 1-14	51	27	28.58
2GF-1219	-12 3/4-14	-19 1.3/16-12	56	32	34.93

2GF*R
BSP Male x ORFS Female Swivel Union

O-Ring + Ret. Ring

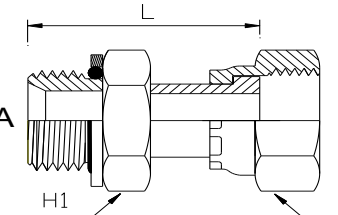

Item No	A-BSP	B-ORFS	L	H1	H
2GF-0409R	-04 1/4-19	-09 9/16-18	38	19	17.46
2GF-0411R	-04 1/4-19	-11 11/16-16	40	19	20.64
2GF-0611R	-06 3/8-19	-11 11/16-16	40	22	20.64
2GF-0813R	-08 1/2-14	-13 13/16-16	48	27	23.81
2GF-0816R	-08 1/2-14	-16 1-14	51	27	28.58
2GF-1219R	-12 3/4-14	-19 1.3/16-12	56	32	34.93
2GF-1623R	-16 1-11	-23 1.7/16-12	62	38	41.28

2GJ
BSPP Male x JIC Female Swivel Union

Encapsulated Seal Type

	Item No	A-BSPP	B-JIC	L	H1	H
	2GJ-0207	-02 1/8-28	-07 7/16-20	23	14	14.29
	2GJ-0407	-04 1/4-19	-07 7/16-20	28	19	14.29
	2GJ-0409	-04 1/4-19	-09 9/16-18	31	19	17.46
	2GJ-0412	-04 1/4-19	-12 3/4-16	33	22	22.23
	2GJ-0609	-06 3/8-19	-09 9/16-18	32	22	17.46
	2GJ-0612	-06 3/8-19	-12 3/4-16	33	22	22.23
	2GJ-0614	-06 3/8-19	-14 7/8-14	34	22	25.40
	2GJ-0809	-08 1/2-14	-09 9/16-18	36	27	17.46
	2GJ-0812	-08 1/2-14	-12 3/4-16	37	27	22.23
	2GJ-0814	-08 1/2-14	-14 7/8-14	38	27	25.40
	2GJ-0817	-08 1/2-14	-17 1.1/16-12	39	32	31.75
	2GJ-0821	-08 1/2-14	-21 1.5/16-12	43	38	41 *
	2GJ-1212	-12 3/4-14	-12 3/4-16	40	32	22.23
	2GJ-1214	-12 3/4-14	-14 7/8-14	40	32	25.40
	2GJ-1217	-12 3/4-14	-17 1.1/16-12	41	32	31.75
	2GJ-1221	-12 3/4-14	-21 1.5/16-12	47	38	41 *
	2GJ-1617	-16 1-11	-17 1.1/16-12	44	41	31.75
	2GJ-1621	-16 1-11	-21 1.5/16-12	47	41	41 *
	2GJ-1626	-16 1-11	-26 1.5/8-12	51	46	50 *
	2GJ-1626	-20 1.1/4-12	-26 1.5/8-12	55	50	50 *
	2GJ-2021	-20 1.1/4-12	-21 1.5/16-12	57	50	41 *
	2GJ-2026	-20 1.1/4-12	-26 1.5/8-12	55	50	50 *
	2GJ-2030	-20 1.1/4-12	-30 1.7/8-12	60	55	55 *
	2GJ-2430	-24 1.1/2-11	-30 1.7/8-12	60	55	55 *
	2GJ-3230	-32 2-11	-30 1.7/8-12	69	70	55 *
	2GJ-3240	-32 2-11	-40 2.1/2-12	72	70	70 *

Note - * denotes wire type nut.

2GJ*R
BSPP Male x JIC Female Swivel Union

O-Ring + Ret. Ring

	Item No	A-BSPP	B-JIC	L	H1	H
	2GJ-0207R	-02 1/8-28	-07 7/16-20	23	14	14.29
	2GJ-0407R	-04 1/4-19	-07 7/16-20	28	19	14.29
	2GJ-0409R	-04 1/4-19	-09 9/16-18	31	19	17.46
	2GJ-0412R	-04 1/4-19	-12 3/4-16	33	22	22.23
	2GJ-0607R	-06 3/8-19	-07 7/16-20	28	22	14.29
	2GJ-0609R	-06 3/8-19	-09 9/16-18	32	22	17.46
	2GJ-0612R	-06 3/8-19	-12 3/4-16	33	22	22.23
	2GJ-0614R	-06 3/8-19	-14 7/8-14	34	22	25.40
	2GJ-0809R	-08 1/2-14	-09 9/16-18	36	27	17.46
	2GJ-0812R	-08 1/2-14	-12 3/4-16	37	27	22.23
	2GJ-0814R	-08 1/2-14	-14 7/8-14	38	27	25.40
	2GJ-0817R	-08 1/2-14	-17 1.1/16-12	39	32	31.75
	2GJ-1212R	-12 3/4-14	-12 3/4-16	40	32	22.23
	2GJ-1214R	-12 3/4-14	-14 7/8-14	40	32	25.40
	2GJ-1217R	-12 3/4-14	-17 1.1/16-12	41	32	31.75
	2GJ-1617R	-16 1-11	-17 1.1/16-12	44	41	31.75
	2GJ-1621R	-16 1-11	-21 1.5/16-12	47	41	41 *
	2GJ-2021R	-20 1.1/4-11	-21 1.5/16-12	47	50	41 *
	2GJ-2026R	-20 1.1/4-11	-26 1.5/8-12	50	50	50 *
	2GJ-2426R	-24 1.1/2-11	-26 1.5/8-12	54	55	50 *

Note - * denotes wire type nut.

Selection Guide - JIC Expander * Reducer * Union

Straight Male / Female adaptors are available in different styles, One Piece (solid), Two Piece (nut and insert), Crimp Nut
 The selection chart below simplifies selection and availability. After identifying the item required, scroll down for more detailed information required for the item.

	Part Number Selection			Size	Size
	One Piece	Two Piece	Union	A	B
	2J1-0607			-06 3/8-20	-07 7/16-20
			2J-0707	-07 7/16-20	-07 7/16-20
	2J1-0709		2J-0709	-07 7/16-20	-09 9/16-18
	2J1-0712		2J-0712	-07 7/16-20	-12 3/4-16
	2J1-0807			-08 1/2-20	-07 7/16-20
			2J-0808	-08 1/2-20	-08 1/2-20
	2J1-0809		2J-0809	-08 1/2-20	-09 9/16-18
	2J1-0907	2J2-0907		-09 9/16-18	-07 7/16-20
	2J1-0908			-09 9/16-18	-08 1/2-20
	2J1-0909		2J-0909	-09 9/16-18	-09 9/16-18
	2J1-0912		2J-0912	-09 9/16-18	-12 3/4-16
	2J1-0914		2J-0914	-09 9/16-18	-14 7/8-14
	2J1-1207	2J2-1207		-12 3/4-16	-07 7/16-20
	2J1-1209	2J2-1209		-12 3/4-16	-09 9/16-18
			2J-1212	-12 3/4-16	-12 3/4-16
	2J1-1214		2J-1214	-12 3/4-16	-14 7/8-14
	2J1-1217		2J-1217	-12 3/4-16	-17 1.1/16-12
	2J1-1221			-12 3/4-16	-21 1.5/16-12
	2J1-1407	2J2-1407		-14 7/8-14	-07 7/16-20
	2J1-1409	2J2-1409		-14 7/8-14	-09 9/16-18
	2J1-1412		2J-1412	-14 7/8-14	-12 3/4-16
			2J-1414	-14 7/8-14	-14 7/8-14
	2J1-1417		2J-1417	-14 7/8-14	-17 1.1/16-12
	2J1-1421			-14 7/8-14	-21 1.5/16-12
	2J1-1707	2J2-1707		-17 1.1/16-12	-07 7/16-20
	2J1-1709	2J2-1709		-17 1.1/16-12	-09 9/16-18
	2J1-1712	2J2-1712	2J-1712	-17 1.1/16-12	-12 3/4-16
	2J1-1714		2J-1714	-17 1.1/16-12	-14 7/8-14
			2J-1717	-17 1.1/16-12	-17 1.1/16-12
	2J1-1721		2J-1721	-17 1.1/16-12	-21 1.5/16-12
	2J1-1917			-19 1.3/16-12	-17 1.1/16-12
	2J1-2107			-21 1.5/16-12	-07 7/16-20
	2J1-2109	2J2-2109		-21 1.5/16-12	-09 9/16-18
	2J1-2112	2J2-2112		-21 1.5/16-12	-12 3/4-16
	2J1-2114	2J2-2114		-21 1.5/16-12	-14 7/8-14
	2J1-2117	2J2-2117	2J-2117	-21 1.5/16-12	-17 1.1/16-12
			2J-2121	-21 1.5/16-12	-21 1.5/16-12
	2J1-2126		2J-2126	-21 1.5/16-12	-26 1.5/8-12
	2J1-2130			-21 1.5/16-12	-30 1.7/8-12
	2J1-2612			-26 1.5/8-12	-12 3/4-16
	2J1-2617	2J2-2617		-26 1.5/8-12	-17 1.1/16-12
	2J1-2621	2J2-2621	2J-2621	-26 1.5/8-12	-21 1.5/16-12
			2J-2626	-26 1.5/8-12	-26 1.5/8-12
	2J1-2630		2J-2630	-26 1.5/8-12	-30 1.7/8-12
	2J1-3017			-30 1.7/8-12	-17 1.1/16-12
	2J1-3021	2J2-3021		-30 1.7/8-12	-21 1.5/16-12
	2J1-3026	2J2-3026	2J-3026	-30 1.7/8-12	-26 1.5/8-12
			2J-3030	-30 1.7/8-12	-30 1.7/8-12
	2J1-3040			-30 1.7/8-12	-40 2.1/2-12
	2J1-4026			-40 2.1/2-12	-26 1.5/8-12
	2J1-4030			-40 2.1/2-12	-30 1.7/8-12
			2J-2020	-40 2.1/2-12	-40 2.1/2-12

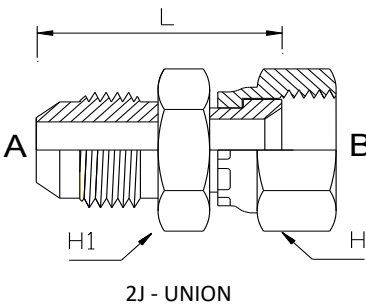
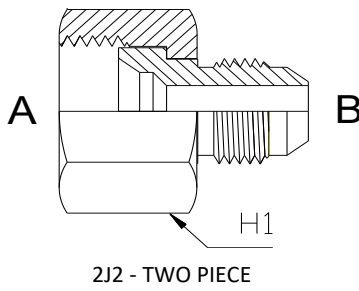
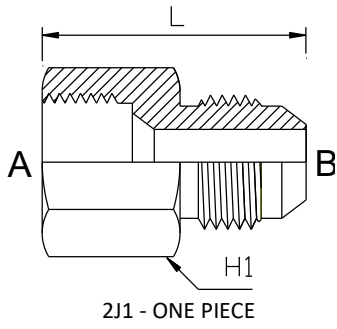
Note - Sizing Order

2J1 (One Piece) and 2J2 (Two Piece) A = Female, B = Male
 2J (Union) A = Male, B = Female

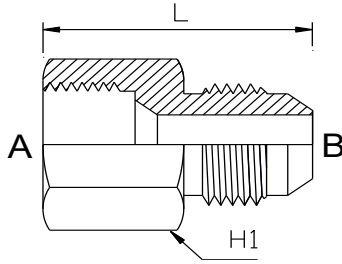
2J1
JIC Female x JIC Male Expander/Reducer One Piece

Item No	A-JIC	B-JIC	L	H1
2J1-0607	-06 3/8-20	-07 7/16-20	28	12.70
2J1-0709	-07 7/16-20	-09 9/16-18	29	15.88
2J1-0712	-07 7/16-20	-12 3/4-16	32	20.64
2J1-0807	-08 1/2-20	-07 7/16-20	29	15.88
2J1-0809	-08 1/2-20	-09 9/16-18	30	15.88
2J1-0907	-09 9/16-18	-07 7/16-20	30	17.46
2J1-0908	-09 9/16-18	-08 1/2-20	30	17.46
2J1-0909	-09 9/16-18	-09 9/16-18	30	17.46
2J1-0912	-09 9/16-18	-12 3/4-16	33	20.64
2J1-0914	-09 9/16-18	-14 7/8-14	35	23.83
2J1-1207	-12 3/4-16	-07 7/16-20	33	22.23
2J1-1209	-12 3/4-16	-09 9/16-18	33	22.23
2J1-1214	-12 3/4-16	-14 7/8-14	38	23.83
2J1-1217	-12 3/4-16	-17 1.1/16-12	41	28.58
2J1-1221	-12 3/4-16	-21 1.5/16-12	42	34.93
2J1-1407	-14 7/8-14	-07 7/16-20	35	23.83
2J1-1409	-14 7/8-14	-09 9/16-18	36	23.83
2J1-1412	-14 7/8-14	-12 3/4-16	38	23.83
2J1-1417	-14 7/8-14	-17 1.1/16-12	43	28.58
2J1-1421	-14 7/8-14	-21 1.5/16-12	45	34.93
2J1-1707	-17 1.1/16-12	-07 7/16-20	37	31.75
2J1-1709	-17 1.1/16-12	-09 9/16-18	37	31.75
2J1-1712	-17 1.1/16-12	-12 3/4-16	40	31.75
2J1-1714	-17 1.1/16-12	-14 7/8-14	42	31.75
2J1-1721	-17 1.1/16-12	-21 1.5/16-12	46	34.93
2J1-1917	-19 1.3/16-12	-17 1.1/16-12	47	34.93
2J1-2107	-21 1.5/16-12	-07 7/16-20	40	38.10
2J1-2109	-21 1.5/16-12	-09 9/16-18	40	38.10
2J1-2112	-21 1.5/16-12	-12 3/4-16	42	38.10
2J1-2114	-21 1.5/16-12	-14 7/8-14	45	38.10
2J1-2117	-21 1.5/16-12	-17 1.1/16-12	48	38.10
2J1-2126	-21 1.5/16-12	-26 1.5/8-12	50	42.88
2J1-2130	-21 1.5/16-12	-30 1.7/8-12	53	50.80
2J1-2612	-26 1.5/8-12	-12 3/4-16	49	50.80
2J1-2617	-26 1.5/8-12	-17 1.1/16-12	49	50.80
2J1-2621	-26 1.5/8-12	-21 1.5/16-12	50	50.80
2J1-2630	-26 1.5/8-12	-30 1.7/8-12	55	50.80
2J1-3017	-30 1.7/8-12	-17 1.1/16-12	52	57.15
2J1-3021	-30 1.7/8-12	-21 1.5/16-12	53	57.15
2J1-3026	-30 1.7/8-12	-26 1.5/8-12	55	57.15
2J1-3040	-30 1.7/8-12	-40 2.1/2-12	64	66.68
2J1-4026	-40 2.1/2-12	-26 1.5/8-12	61	73.00
2J1-4030	-40 2.1/2-12	-30 1.7/8-12	64	73.00

JIC Male x Female selection guide - see Page..... 28

RESTRICTOR				ORIFICE
2J1-0707-R0.4	-07 7/16-20	-07 7/16-20	29	14.27 0.4
2J1-0707-R0.6	-07 7/16-20	-07 7/16-20	29	14.27 0.6
2J1-0909-R0.6	-09 9/16-18	-09 9/16-18	30	17.46 0.6
2J1-0909-R0.9	-09 9/16-18	-09 9/16-18	30	17.46 0.9
2J1-0909-R1.2	-09 9/16-18	-09 9/16-18	30	17.46 1.2
2J1-1212-R0.9	-12 3/4-16	-09 9/16-18	36	22.23 0.9
2J1-1212-R1.2	-12 3/4-16	-09 9/16-18	36	22.23 1.2
2J1-1212-R2.0	-12 3/4-16	-09 9/16-18	36	22.23 2.0

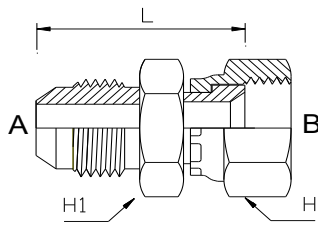
2J
JIC Male x JIC Female

Item No	A-JIC	B-JIC	L	H1	H
2J-0707	-07 7/16-20	-07 7/16-20	30	12.70	14.27
2J-0709	-07 7/16-20	-09 9/16-18	31	14.27	17.46
2J-0712	-07 7/16-20	-12 3/4-16			22.23
2J-0808	-08 1/2-20	-08 1/2-20	30	14.27	15.88
2J-0809	-08 1/2-20	-09 9/16-18	31	14.27	17.46
2J-0909	-09 9/16-18	-09 9/16-18	32	15.88	17.46
2J-0912	-09 9/16-18	-12 3/4-16	36	20.64	22.23
2J-0914	-09 9/16-18	-14 7/8-14			25.40
2J-1209	-12 3/4-16	-09 9/16-18	34	20.62	17.46
2J-1212	-12 3/4-16	-12 3/4-16	36	20.64	22.23
2J-1214	-12 3/4-16	-14 7/8-14	40	23.80	25.40
2J-1217	-12 3/4-16	-17 1.1/16-12	41	28.58	31.75
2J-1412	-14 7/8-14	-12 3/4-16	39	24.00	22.23
2J-1414	-14 7/8-14	-14 7/8-14	41	24.00	25.40
2J-1417	-14 7/8-14	-17 1.1/16-12			31.75
2J-1712	-17 1.1/16-12	-12 3/4-16			22.23
2J-1714	-17 1.1/16-12	-14 7/8-14			25.40
2J-1717	-17 1.1/16-12	-17 1.1/16-12	46	28.58	31.75
2J-1721	-17 1.1/16-12	-21 1.5/16-12	47	34.90	38.10
2J-2117	-21 1.5/16-12	-17 1.1/16-12	47	34.90	31.75
2J-2121	-21 1.5/16-12	-21 1.5/16-12	49	34.93	38.10
2J-2126	-21 1.5/16-12	-26 1.5/8-12	51	42.88	50.80
2J-2621	-26 1.5/8-12	-21 1.5/16-12			38.10
2J-2626	-26 1.5/8-12	-26 1.5/8-12	54	42.88	50.80
2J-2630	-26 1.5/8-12	-30 1.7/8-12	57	50.80	57.15
2J-3026	-30 1.7/8-12	-26 1.5/8-12			50.80
2J-3030	-30 1.7/8-12	-30 1.7/8-12	60	50.80	57.15
2J-4040	-40 2.1/2-12	-40 2.1/2-12	94	73.00	67.95

JIC Male x Female selection guide - see Page..... 28

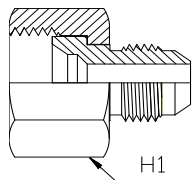
2J2
JIC Female x JIC Male Expander/Reducer Nut+Insert

Item No	A-JIC	B-JIC	L	H1
2J2-0907	-09 9/16-18	-07 7/16-20	25	17.46
2J2-1207	-12 3/4-16	-07 7/16-20	25	22.23
2J2-1209	-12 3/4-16	-09 9/16-18	25	22.23
2J2-1407	-14 7/8-14	-07 7/16-20	26	25.40
2J2-1409	-14 7/8-14	-09 9/16-18	26	25.40
2J2-1707	-17 1.1/16-12	-07 7/16-20	28	31.75
2J2-1709	-17 1.1/16-12	-09 9/16-18	28	31.75
2J2-1712	-17 1.1/16-12	-12 3/4-16	28	31.75
2J2-2109	-21 1.5/16-12	-09 9/16-18	31	38.10
2J2-2112	-21 1.5/16-12	-12 3/4-16	32	38.10
2J2-2114	-21 1.5/16-12	-14 7/8-14	35	38.10
2J2-2117	-21 1.5/16-12	-17 1.1/16-12	37	38.10
2J2-2617	-26 1.5/8-12	-17 1.1/16-12	39	50.80
2J2-2621	-26 1.5/8-12	-21 1.5/16-12	40	50.80
2J2-3021	-30 1.7/8-12	-21 1.5/16-12	41	51.15
2J2-3026	-30 1.7/8-12	-26 1.5/8-12	43	57.15

JIC Male x Female selection guide - see Page..... 28

2JTNS
JIC Tube Nut and Sleeve

SAE Specification

	Item No	A-JIC	B-TUBE	H	Component P/N	
					Nut	Sleeve
	2JTNS-0704	-07 7/16-20	-04 1/4"	14.29	2J200-07	2J300-07
	2JTNS-0805	-08 1/2-20	-05 5/16"	15.88	2J200-08	2J300-08
	2JTNS-0906	-09 9/16-18	-06 3/8"	17.46	2J200-09	2J300-09
	2JTNS-0906S	-09 9/16-18	-06 3/8"	17.46	2J200-09	2J300-09S
	2JTNS-1208	-12 3/4-16	-08 1/2"	22.23	2J200-12	2J300-12
	2JTNS-1410	-14 7/8-14	-10 5/8"	25.40	2J200-14	2J300-14
	2JTNS-1410S	-14 7/8-14	-10 5/8"	25.40	2J200-14	2J300-14S
	2JTNS-1712	-17 1.1/16-12	-12 3/4"	31.75	2J200-17	2J300-17
	2JTNS-1914	-19 1.3/16-12	-14 7/8"	34.93	2J200-19	2J300-19
	2JTNS-2116	-21 1.5/16-12	-16 1"	38.10	2J200-21	2J300-21
	2JTNS-2116S	-21 1.5/16-12	-16 1"	38.10	2J200-21	2J300-21S
	2JTNS-2620	-26 1.5/8-12	-20 1.1/4"	50.80	2J200-26	2J300-26
	2JTNS-3024	-30 1.7/8-12	-24 1.1/2"	57.15	2J200-30	2J300-30
	2JTNS-4032	-40 2.1/2-12	-32 2"	73.00	2J200-40	2J300-40

"Short" Sleeve available in -09, -12 and -14. Add suffix "S" to the Item No (eg 2J300-14S)
 Components (Nut and Sleeve) available seperately

2JB
JIC Male x BSP Female Union

	Item No	A-JIC	B-BSP	L	H1	H
	2JB-0704	-07 7/16-20	-04 1/4-19	31	14	19
	2JB-0706	-07 7/16-20	-06 3/8-19	32	17	22
	2JB-0904	-09 9/16-18	-04 1/4-19	31	17	19
	2JB-0906	-09 9/16-18	-06 3/8-19	33	17	22
	2JB-1204	-12 3/4-16	-04 1/4-19	36	22	19
	2JB-1208	-12 3/4-16	-08 1/2-14	40	22	27
	2JB-1408	-14 7/8-14	-08 1/2-14	43	24	27
	2JB-1712	-17 1.1/16-12	-12 3/4-14	45	30	32
	2JB-1716	-17 1.1/16-12	-16 1-11	54	36	41 *
	2JB-2116	-21 1.5/16-12	-16 1-11	54	36	41 *

Note - * denotes wire type nut.

2JF
JIC Male x ORFS Female Union

SAE Specification

Item No	A-JIC	B-ORFS	L	H1	H
2JF-0709	-07 7/16-20	-09 9/16-18	31	15.8	17.5
2JF-0711	-07 7/16-20	-11 11/16-16	42	19.1	20.6
2JF-0809	-08 1/2-20	-09 9/16-18	31	19.1	17.5
2JF-0911	-09 9/16-18	-11 11/16-16	32	19.0	20.6
2JF-0913	-09 9/16-18	-13 13/16-16	35	22.2	23.8
2JF-1213	-12 3/4-16	-13 13/16-16	37	22.2	23.8
2JF-1413	-14 7/8-14	-13 13/16-16	40	25.4	23.8
2JF-1416	-14 7/8-14	-16 1-14	44	27.0	28.6
2JF-1419	-14 7/8-14	-19 1.3/16-12	48	27.0	34.9
2JF-1423	-14 7/8-14	-23 1.7/16-12	48	38.1	41.3
2JF-1719	-17 1.1/16-12	-19 1.3/16-12	49	31.8	34.9
2JF-2123	-21 1.5/16-12	-23 1.7/16-12	52	38.1	41.3
2JF-2623	-26 1.5/8-12	-23 1.7/16-12	55	42.9	41.3
2JF-2627	-26 1.5/8-12	-27 1.11/16-12	58	47.6	47.6

2NJ
NPT Male x JIC Female

SAE Specification

Item No	A-NPT	B-JIC	L	H1	H
2NJ-0207	-02 1/8-27	-07 7/16-20	25	12.7	14.3
2NJ-0209	-02 1/8-27	-09 9/16-18		14.3	17.5
2NJ-0407	-04 1/4-18	-07 7/16-20	31	14.3	14.3
2NJ-0408	-04 1/4-18	-08 1/2-20	32	14.3	15.9
2NJ-0409	-04 1/4-18	-09 9/16-18	33	14.3	17.5
2NJ-0607	-06 3/8-18	-07 7/16-20	31	19.0	14.3
2NJ-0609	-06 3/8-18	-09 9/16-18	32	19.0	17.5
2NJ-0612	-06 3/8-18	-12 3/4-16	33	22.2	22.2
2NJ-0614	-06 3/8-18	-14 7/8-14	36	22.2	25.4
2NJ-0807	-08 1/2-14	-07 7/16-20	37	22.2	14.3
2NJ-0809	-08 1/2-14	-09 9/16-18	39	22.2	17.5
2NJ-0812	-08 1/2-14	-12 3/4-16	40	22.2	22.2
2NJ-0814	-08 1/2-14	-14 7/8-14	41	25.4	25.4
2NJ-0817	-08 1/2-14	-17 1.1/16-12	40	25.4	31.8
2NJ-1212	-12 3/4-14	-12 3/4-16	43	28.6	22.2
2NJ-1214	-12 3/4-14	-14 7/8-14	43	28.6	25.4
2NJ-1217	-12 3/4-14	-17 1.1/16-12	44	28.6	31.8
2NJ-1221	-12 3/4-14	-21 1.5/16-12	45	34.9	38.1
2NJ-1617	-16 1-11.5	-17 1.1/16-12	49	34.9	31.8
2NJ-1621	-16 1-11.5	-21 1.5/16-12	50	34.9	38.1
2NJ-2026	-20 1.1/4-11.5	-26 1.5/8-12	56	42.9	50.8
2NJ-2430	-24 1.1/2-11.5	-30 1.7/8-12	57	50.8	57.2
2NJ-3240	-32 2-11.5	-40 2.1/2-12	64	66.7	73.0

2NU
NPT Male x NPSM Female

SAE Specification

	Item No	A-NPT	B-NPSM	L	H1	H
	2NU-0202	-02 1/8-27	-02 1/8-27	24	14.3	14.3
	2NU-0204	-02 1/8-27	-04 1/4-18	28	17.5	17.5
	2NU-0404	-04 1/4-18	-04 1/4-18	33	17.5	17.5
	2NU-0406	-04 1/4-18	-06 3/8-18	34	20.6	22.2
	2NU-0408	-04 1/4-18	-08 1/2-14	38	25.4	25.4
	2NU-0604	-06 3/8-18	-04 1/4-18	35	19.0	17.5
	2NU-0606	-06 3/8-18	-06 3/8-18	34	22.2	22.2
	2NU-0608	-06 3/8-18	-08 1/2-14	38	25.4	25.4
	2NU-0804	-08 1/2-14	-04 1/4-18	40	22.2	17.5
	2NU-0806	-08 1/2-14	-06 3/8-18	41	22.2	22.2
	2NU-0808	-08 1/2-14	-08 1/2-14	43	25.4	25.4
	2NU-0812	-08 1/2-14	-12 3/4-14	45	31.8	31.8
	2NU-1204	-12 3/4-14	-04 1/4-18	40	28.6	17.5
	2NU-1206	-12 3/4-14	-06 3/8-18	41	28.6	22.2
	2NU-1208	-12 3/4-14	-08 1/2-14	44	28.6	25.4
	2NU-1212	-12 3/4-14	-12 3/4-14	45	31.8	31.8
	2NU-1216	-12 3/4-14	-16 1-11.5	46	38.1	38.1
	2NU-1612	-16 1-11.5	-12 3/4-14	50	38.1	31.8
	2NU-1616	-16 1-11.5	-16 1-11.5	51	38.1	38.1
	2NU-1620	-16 1-11.5	-20 1.1/4-11.5	53	47.6	47.6
2NU-2016	-20 1.1/4-11.5	-16 1-11.5	53	47.6	38.1	
2NU-2020	-20 1.1/4-11.5	-20 1.1/4-11.5	54	47.6	47.6	
2NU-2024	-20 1.1/4-11.5	-24 1.1/2-11.5	54	54.0	54.0	
2NU-2424	-24 1.1/2-11.5	-24 1.1/2-11.5	58	54.0	54.0	
2NU-3232	-32 2-11.5	-32 2-11.5	61	66.7	66.7	

2OB
UNO Male x BSPP Female

	Item No	A-UNO	B-BSPP	L	H1	H
	2OB-0704	-07 7/16-20	-04 1/4-19	29	17	19
	2OB-0904	-09 9/16-18	-04 1/4-19	30	17	19
	2OB-0906	-09 9/16-18	-06 3/8-19	32	22	22
	2OB-0908	-09 9/16-18	-08 1/2-14	30	22	27
	2OB-1206	-12 3/4-16	-06 3/8-19	31	22	22
	2OB-1208	-12 3/4-16	-08 1/2-14	33	22	27
	2OB-1406	-14 7/8-14	-06 3/8-19	36	27	22
	2OB-1408	-14 7/8-14	-08 1/2-14	38	27	27
	2OB-1412	-14 7/8-14	-12 3/4-14	43	27	32
	2OB-1708	-17 1.1/16-12	-08 1/2-14	43	32	27
	2OB-1712	-17 1.1/16-12	-12 3/4-14	41	42	32
	2OB-1716	-17 1.1/16-12	-16 1-11	49	38	41 *
	2OB-2116	-21 1.5/16-12	-16 1-11	49	38	41 *

Note - * denotes wire type nut.

2OF
UNO Male x ORFS Female

SAE Specification

	Item No	A-UNO	B-ORFS	L	H1	H
	2OF-0709	-07 7/16-20	-09 9/16-18	37	15.9	17.5
	2OF-0911	-09 9/16-18	-11 11/16-16	40	19.0	20.6
	2OF-1213	-12 3/4-16	-13 13/16-16	49	22.2	23.8
	2OF-1416	-14 7/8-14	-16 1-14	54	27.0	28.6
	2OF-1719	-17 1.1/16-12	-19 1.3/16-12	60	31.8	34.9
	2OF-2123	-21 1.5/16-16	-23 1.7/16-12	68	38.1	41.3
	2OF-2627	-26 1.5/8-12	-27 1.11/16-12	68	47.6	47.6

20J
UNO Male x JIC Female

SAE Specification

	Item No	A-UNO	B-JIC	L	H1	H
	20J-0707	-07 7/16-20	-07 7/16-20	26	14.0	14.3
	20J-0709	-07 7/16-20	-09 9/16-18	28	17.0	17.5
	20J-0808	-08 1/2-20	-08 1/2-20	28	17.0	15.9
	20J-0907	-09 9/16-18	-07 7/16-20	27	17.0	17.5
	20J-0909	-09 9/16-18	-09 9/16-18	29	17.0	17.5
	20J-0912	-09 9/16-18	-09 3/4-16	30	19.0	22.2
	20J-1209	-12 3/4-16	-09 9/16-18	31	22.0	17.5
	20J-1212	-12 3/4-16	-12 3/4-16	33	22.0	22.2
	20J-1214	-12 3/4-16	-14 7/8-14	33	22.0	25.4
	20J-1217	-12 3/4-16	-17 1.1/16-12	37	28.6	31.8
	20J-1409	-14 7/8-14	-09 9/16-18	34	22.2	17.5
	20J-1412	-14 7/8-14	-12 3/4-16	36	27.0	22.2
	20J-1414	-14 7/8-14	-14 7/8-14	36	27.0	25.4
	20J-1417	-14 7/8-14	-17 1.1/16-12	41	28.6	31.8
	20J-1712	-17 1.1/16-12	-12 3/4-16	41	31.8	22.2
	20J-1714	-17 1.1/16-12	-14 7/8-14	41	31.8	25.4
	20J-1717	-17 1.1/16-12	-17 1.1/16-12	41	31.8	32.0
	20J-1721	-17 1.1/16-12	-21 1.5/16-12	43	34.9	38.1
	20J-2117	-21 1.5/16-12	-17 1.1/16-12	44	38.1	31.8
	20J-2121	-21 1.5/16-12	-21 1.5/16-12	44	38.1	38.0
20J-2626	-26 1.5/8-12	-26 1.5/8-12	47	50.8	50.0	
20J-3030	-30 1.7/8-12	-30 1.7/8-12	51	73.0	55.0	

20U
UNO Male x NPSM Female

SAE Specification

	Item No	A-UNO	B-NPSM	L	H1	H
	20U-0704	-07 7/16-20	-04 1/4-18	28	14.3	17.5
	20U-0904	-09 9/16-18	-04 1/4-18	27	17.5	17.5
	20U-0906	-09 9/16-18	-06 3/8-18	32	17.5	22.2
	20U-0908	-09 9/16-18	-08 1/2-14	33	20.6	25.4
	20U-1204	-12 3/4-16	-04 1/4-18	30	22.2	17.5
	20U-1206	-12 3/4-16	-06 3/8-18	30	22.2	22.2
	20U-1208	-12 3/4-16	-08 1/2-14	32	22.2	25.4
	20U-1406	-14 7/8-14	-06 3/8-18	32	25.4	22.2
	20U-1408	-14 7/8-14	-08 1/2-14	34	25.4	25.4
	20U-1712	-17 1.1/16-12	-12 3/4-14	41	31.8	31.8
	20U-2116	-21 1.5/16-12	-16 1-11.5	43	38.1	38.1
	20U-2620	-26 1.5/8-12	-20 1.1/4-11.5	45	47.6	47.6

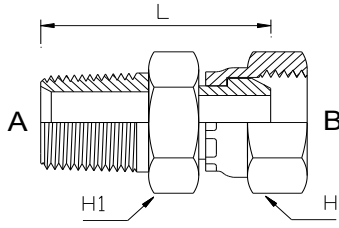
2TB
BSPT Male x BSPP Female

Item No	A-BSPT	B-BSPP	L	H1	H
2TB-0202	-02 1/8-28	-02 1/8-28	25	12	14
2TB-0204	-02 1/8-28	-04 1/4-19	27	12	19
2TB-0402	-04 1/4-19	-02 1/8-28	30	17	14
2TB-0404	-04 1/4-19	-04 1/4-19	32	17	19
2TB-0406	-04 1/4-19	-06 3/8-19	34	19	22
2TB-0408	-04 1/4-19	-08 1/2-19	35	19	27
2TB-0604	-06 3/8-19	-04 1/4-19	32	19	19
2TB-0606	-06 3/8-19	-06 3/8-19	33	19	22
2TB-0608	-06 3/8-19	-08 1/2-14	35	19	27
2TB-0612	-06 3/8-19	-12 3/4-14	42	22	32
2TB-0804	-08 1/2-14	-04 1/4-19	39	22	19
2TB-0806	-08 1/2-14	-06 3/8-19	40	22	22
2TB-0808	-08 1/2-14	-08 1/2-14	44	22	27
2TB-0812	-08 1/2-14	-12 3/4-14	45	27	32
2TB-0816	-08 1/2-14	-16 1-11	52	38	41 *
2TB-1208	-12 3/4-14	-08 1/2-14	46	30	27
2TB-1212	-12 3/4-14	-12 3/4-14	45	30	32
2TB-1216	-12 3/4-14	-16 1-11	50	32	41 *
2TB-1612	-16 1-11	-12 3/4-14	49	36	32
2TB-1616	-16 1-11	-16 1-11	54	36	41 *
2TB-1620	-16 1-11	-20 1.1/4-11	60	46	50 *
2TB-2016	-20 1.1/4-11	-16 1-11	57	46	41 *
2TB-2020	-20 1.1/4-11	-20 1.1/4-11	59	46	50 *
2TB-2024	-20 1.1/4-11	-24 1.1/2-11	61	50	55 *
2TB-2420	-24 1.1/2-11	-20 1.1/4-11	63	50	55 *
2TB-2424	-24 1.1/2-11	-24 1.1/2-11	63	50	55 *
2TB-3232	-32 2-11	-32 2-11	73	65	70 *

Note - * denotes wire type nut.

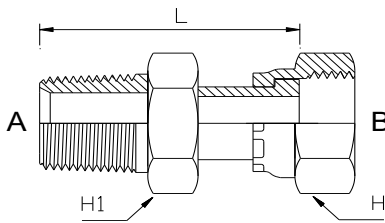
2TF
BSPT Male x ORFS Female

Item No	A-BSPT	B-ORFS	L	H1	H
2TF-0409	-04 1/4-19	-09 9/16-18	38	17	17.5
2TF-0611	-06 3/8-19	-11 11/16-16	41	19	20.6
2TF-0813	-08 1/2-14	-13 13/16-16	49	22	23.8
2TF-1219	-12 3/4-14	-19 1.3/16-12	59	30	34.9
2TF-1623	-16 1-11	-23 1.7/16-12	66	36	41.3

2TJ
BSPT Male x JIC Female

	Item No	A-BSPT	B-JIC	L	H1	H
	2TJ-0207	-02 1/8-28	-07 7/16-20	24	12	14.3
	2TJ-0209	-02 1/8-28	-09 9/16-18	26	14	17.5
	2TJ-0407	-04 1/4-19	-07 7/16-20	28	14	14.3
	2TJ-0409	-04 1/4-19	-09 9/16-18	29	14	17.5
	2TJ-0412	-04 1/4-19	-12 3/4-16	35	19	22.2
	2TJ-0414	-04 1/4-19	-14 7/8-14	34	24	25.4
	2TJ-0607	-06 3/8-19	-07 7/16-20	28	17	14.3
	2TJ-0609	-06 3/8-19	-09 9/16-18	30	17	17.5
	2TJ-0612	-06 3/8-19	-12 3/4-16	31	19	22.2
	2TJ-0614	-06 3/8-19	-14 7/8-14	34	24	25.4
	2TJ-0809	-08 1/2-14	-09 9/16-18	36	22	17.5
	2TJ-0812	-08 1/2-14	-12 3/4-16	38	22	22.2
	2TJ-0814	-08 1/2-14	-14 7/8-14	38	24	25.4
	2TJ-0817	-08 1/2-14	-17 1.1/16-12	42	30	32.0
	2TJ-1212	-12 3/4-14	-12 3/4-16	40	30	22.2
	2TJ-1214	-12 3/4-14	-14 7/8-14	41	30	25.4
	2TJ-1217	-12 3/4-14	-17 1.1/16-12	42	30	32.0
	2TJ-1221	-12 3/4-14	-21 1.5/16-12	45	36	41 *
	2TJ-1617	-16 1-11	-17 1.1/16-12	47	36	32.0
	2TJ-1621	-16 1-11	-21 1.5/16-12	50	36	41 *
2TJ-2021	-20 1.1/4-11	-21 1.5/16-12	55	46	50 *	
2TJ-2026	-20 1.1/4-11	-26 1.5/8-12	57	46	50 *	
2TJ-2426	-24 1.1/2-11	-26 1.5/8-12	58	50	50 *	
2TJ-2430	-24 1.1/2-11	-30 1.7/8-12	62	50	55 *	
2TJ-3240	-32 2-11	-40 2.1/2-12	66	65	70 *	

Note - * denotes wire type nut.

2TKW
BSPT Male x Karcher Female

	Item No	A-BSPT	B-Karcher	L	H1	H
	2TKW-0422	-04 1/4-19	-22 Karcher			
	2TKW-0622	-06 3/8-19	-22 Karcher			

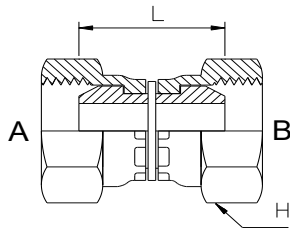
3B
BSP Female Union

Item No	A-BSP	B-BSP	L	H
3B-0404	-04 1/4-19	-04 1/4-19	23	19
3B-0606	-06 3/8-19	-06 3/8-19	26	22
3B-0808	-08 1/2-14	-08 1/2-14	32	27
3B-1212	-12 3/4-14	-12 3/4-14	32	32
3B-1616	-16 1-11	-16 1-11	39	41 *

Note - * denotes wire type nut.

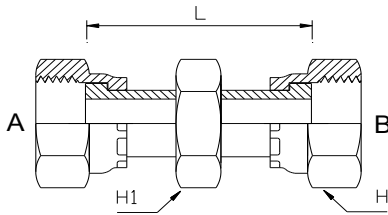
3F
ORFS Female Union

Item No	A-ORFS	B-ORFS	L	H
3F-0909	-09 9/16-18	-09 9/16-18		
3F-1111	-11 11/16-16	-11 11/16-16		
3F-1313	-13 13/16-16	-13 13/16-16		
3F-1616	-16 1-14	-16 1-14		
3F-1919	-19 1.3/16-12	-19 1.3/16-12		
3F-2323	-23 1.7/17-12	-23 1.7/17-12		

3J
JIC Female Union

SAE Specification

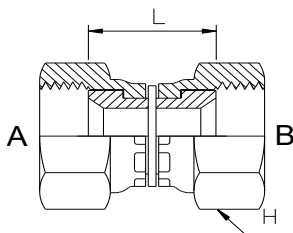

Item No	A-JIC	B-JIC	L	H
3J-0707	-07 7/16-20	-07 7/16-20	18	14.3
3J-0909	-09 9/16-18	-09 9/16-18	21	17.5
3J-1212	-12 3/4-16	-12 3/4-16	24	22.2
3J-1414	-14 7/8-14	-14 7/8-14	25	25.4
3J-1717	-17 1.1/16-12	-17 1.1/16-12	27	31.8
3J-2121	-21 1.5/16-12	-21 1.5/16-12	30	38.1
3J-2626	-26 1.5/8-12	-26 1.5/8-12	33	50.8
3J-3030	-30 1.7/8-12	-30 1.7/8-12	36	57.2

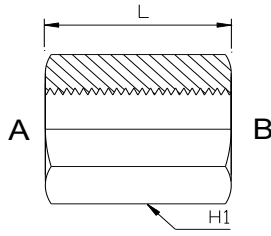
7B
BSPP Socket

Item No	A-BSPP	B-BSPP	L	H1
7B-0202H	-02 1/8-28	-02 1/8-28	20	14
7B-0404H	-04 1/4-19	-04 1/4-19	30	19
7B-0604H	-06 3/8-19	-04 1/4-19	30	22
7B-0606H	-06 3/8-19	-06 3/8-19	30	22
7B-0808H	-08 1/2-14	-08 1/2-14	38	27
7B-1212H	-12 3/4-14	-12 3/4-14	42	36
7B-1616H	-16 1-11	-16 1-11	50	41
7B-2020H	-20 1.1/4-11	-20 1.1/4-11	55	50
7B-2424H	-24 1.1/2-11	-24 1.1/2-11	55	60

7N
NPT Socket

SAE Specification

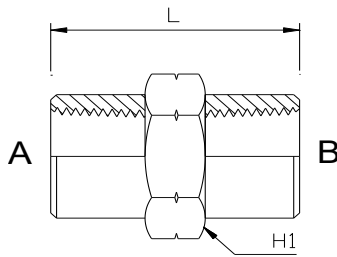

Item No	A-NPT	B-NPT	L	H1
7N-0202	-02 1/8-27	-02 1/8-27	19	15.9
7N-0402	-04 1/4-18	-02 1/8-27	29	19.0
7N-0404	-04 1/4-18	-04 1/4-18	29	19.0
7N-0604	-06 3/8-18	-04 1/4-18	29	22.2
7N-0606	-06 3/8-18	-06 3/8-18	29	22.2
7N-0804	-08 1/2-14	-04 1/4-18	38	28.6
7N-0806	-08 1/2-14	-06 3/8-18	38	28.6
7N-0808	-08 1/2-14	-08 1/2-14	38	28.6
7N-1208	-12 3/4-14	-08 1/2-14	39	34.9
7N-1212	-12 3/4-14	-12 3/4-14	39	34.9
7N-1612	-16 1-11.5	-12 3/4-14	46	41.3
7N-1616	-16 1-11.5	-16 1-11.5	48	41.3
7N-2020	-20 1.1/4-11.5	-20 1.1/4-11.5	49	50.8
7N-2416	-24 1.1/2-11.5	-16 1-11.5	49	60.3
7N-2424	-24 1.1/2-11.5	-24 1.1/2-11.5	49	60.3
7N-3232	-32 2-11.5	-32 2-11.5	50	73.0

7NJ
NPT Fixed Female x JIC Female

SAE Specification

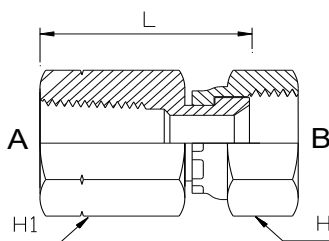

Item No	A-NPT	B-JIC	L	H1	H
7NJ-0207	-02 1/8-27	-07 7/16-20	25	14.3	14.3
7NJ-0407	-04 1/4-18	-07 7/16-20	30	19.0	14.3
7NJ-0409	-04 1/4-18	-09 9/16-18	32	19.0	17.5
7NJ-0607	-06 3/8-18	-07 7/16-20	31	22.2	14.3
7NJ-0609	-06 3/8-18	-09 9/16-18	34	22.2	17.5
7NJ-0612	-06 3/8-18	-12 3/4-16	35	22.2	22.2
7NJ-0809	-08 1/2-14	-09 9/16-18	39	28.6	17.5
7NJ-0812	-08 1/2-14	-12 3/4-16	40	28.6	22.2
7NJ-0814	-08 1/2-14	-14 7/8-14	41	28.6	25.4
7NJ-1217	-12 3/4-14	-17 1.1/16-12	44	34.9	31.8
7NJ-1621	-16 1-11.5	-21 1.5/16-12	52	41.3	38.1

7NU
NPT Fixed x NPSM Female

SAE Specification

	Item No	A-NPT	B-NPSM	L	H1	H
	7NU-0202	-02 1/8-27	-02 1/8-27	22	14.3	14.3
	7NU-0204	-02 1/8-27	-04 1/4-18	28	17.5	17.5
	7NU-0402	-04 1/4-18	-02 1/8-27	30	17.5	14.3
	7NU-0404	-04 1/4-18	-04 1/4-18	31	17.5	17.5
	7NU-0406	-04 1/4-18	-06 3/8-18	32	17.5	22.2
	7NU-0408	-04 1/4-18	-08 1/2-14	34	25.4	25.4
	7NU-0604	-06 3/8-18	-04 1/4-18	33	22.2	17.5
	7NU-0606	-06 3/8-18	-06 3/8-18	33	22.2	22.2
	7NU-0608	-06 3/8-18	-08 1/2-14	38	25.4	25.4
	7NU-0804	-08 1/2-14	-04 1/4-18	40	25.4	17.5
	7NU-0806	-08 1/2-14	-06 3/8-18	37	25.4	22.2
	7NU-0808	-08 1/2-14	-08 1/2-14	40	25.4	25.4
	7NU-0812	-08 1/2-14	-12 3/4-14	41	31.8	31.8
	7NU-1208	-12 3/4-14	-08 1/2-14	41	31.8	25.4
	7NU-1212	-12 3/4-14	-12 3/4-14	41	31.8	31.8
	7NU-1216	-12 3/4-14	-16 1-11.5	46	38.1	38.1
	7NU-1612	-16 1-11.5	-12 3/4-14	48	38.1	31.8
	7NU-1616	-16 1-11.5	-16 1-11.5	51	38.1	38.1
	7NU-2020	-20 1.1/4-11.5	-20 1.1/4-11.5	51	47.6	47.6
	7NU-2424	-24 1.1/2-11.5	-24 1.1/2-11.5	53	54.0	54.0
7NU-3232	-32 2-11.5	-32 2-11.5	54	66.7	66.7	

70
UNO Socket

SAE Specification

	Item No	A-UNO	B-UNO	L	H1
	70-0707	-07 7/16-20	-07 7/16-20	36	15.9
	70-0909	-09 9/16-18	-09 9/16-18	36	19.1
	70-1212	-12 3/4-16	-12 3/4-16	36	27.0
	70-1414	-14 7/8-14	-14 7/8-14	41	28.6
	70-1717	-17 1.1/16-12	-17 1.1/16-12	47	34.9
	70-2121	-21 1.5/16-12	-21 1.5/16-12	47	41.3
	70-2626	-26 1.5/8-12	-26 1.5/8-12	55	50.8

7T
BSPT Socket

Item No	A-BSPT	B-BSPT	L	H1
7T-0202	-02 1/8-28	-02 1/8-28	20	14
7T-0402	-04 1/4-19	-02 1/8-28	30	19
7T-0404	-04 1/4-19	-04 1/4-19	30	19
7T-0602	-06 3/8-19	-02 1/8-28	29	22
7T-0604	-06 3/8-19	-04 1/4-19	30	22
7T-0606	-06 3/8-19	-06 3/8-19	30	22
7T-0804	-08 1/2-14	-04 1/4-19	38	27
7T-0806	-08 1/2-14	-06 3/8-19	38	27
7T-0808	-08 1/2-14	-08 1/2-14	38	27
7T-1208	-12 3/4-14	-08 1/2-14	42	36
7T-1212	-12 3/4-14	-12 3/4-14	42	36
7T-1612	-16 1-11	-12 3/4-14	50	41
7T-1616	-16 1-11	-16 1-11	50	41
7T-2016	-20 1.1/4-11	-16 1-11	55	50
7T-2020	-20 1.1/4-11	-20 1.1/4-11	55	50
7T-2424	-24 1.1/2-11	-24 1.1/2-11	55	55
7T-3232	-32 2-11	-32 2-11	65	70

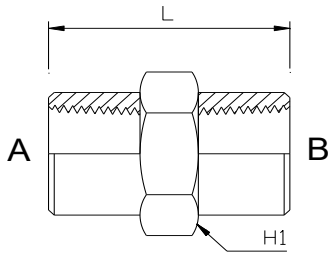

7T-0202H	-02 1/8-28	-02 1/8-28	20	14
7T-0402H	-04 1/4-20	-02 1/8-29	30	19
7T-0404H	-04 1/4-19	-04 1/4-19	30	19
7T-0604H	-06 3/8-20	-04 1/4-20	30	22
7T-0606H	-06 3/8-19	-06 3/8-19	30	22
7T-0804H	-08 1/2-15	-04 1/4-20	38	27
7T-0806H	-08 1/2-15	-06 3/8-20	38	27
7T-0808H	-08 1/2-14	-08 1/2-14	38	27
7T-1208H	-12 3/4-15	-08 1/2-15	42	36
7T-1212H	-12 3/4-14	-12 3/4-14	42	36
7T-1612H	-16 1-12	-12 3/4-15	50	41
7T-1616H	-16 1-11	-16 1-11	50	41
7T-2016H	-20 1.1/4-12	-16 1-12	55	50
7T-2020H	-20 1.1/4-11	-20 1.1/4-11	55	50
7T-2424H	-24 1.1/2-11	-24 1.1/2-11	55	55
7T-3232H	-32 2-11	-32 2-11	65	70

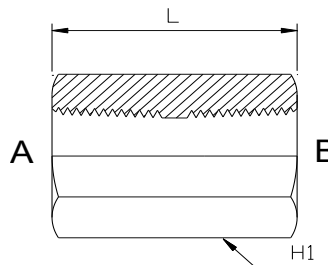

"H" suffix = Full Length Hex type

7TB
BSPT Fixed Female x BSP Swivel Female

Item No	A-BSPT	B-BSPP	L	H1	H
7TB-0404	-04 1/4-19	-04 1/4-19	31	19	19
7TB-0606	-06 3/8-19	-06 3/8-19	33	22	22
7TB-0806	-08 1/2-14	-06 3/8-19	40	27	22
7TB-0808	-08 1/2-14	-08 1/2-14	40	27	27
7TB-1212	-12 3/4-14	-12 3/4-14	42	36	32
7TB-1616	-16 1-11	-16 1-11	48	41	38 *

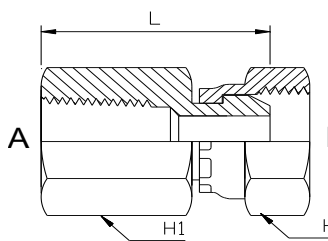

Note - * denotes wire type nut.

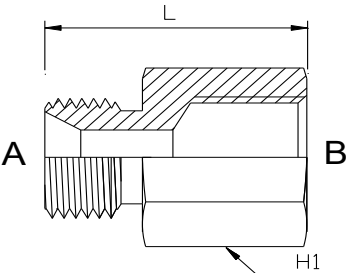
5G
BSPP Male x BSPP Fixed Female

Item No	A-BSPP	B-BSPP	L	H1
5G-0204	-02 1/8-28	-04 1/4-19	28	19
5G-0402	-04 1/4-19	-02 1/8-28	31	19
5G-0404	-04 1/4-19	-04 1/4-19	32	19
5G-0406	-04 1/4-19	-06 3/8-19	34	22
5G-0408	-04 1/4-19	-08 1/2-14	37	27
5G-0606	-06 3/8-19	-06 3/8-19	33	22
5G-0608	-06 3/8-19	-08 1/2-14	39	29
5G-0612	-06 3/8-19	-12 3/4-14	45	36
5G-0806	-08 1/2-14	-06 3/8-19	39	27
5G-0808	-08 1/2-14	-08 1/2-14	40	27
5G-0812	-08 1/2-14	-12 3/4-14	48	36
5G-1212	-12 3/4-14	-12 3/4-14	48	36
5G-1216	-12 3/4-14	-16 1-11	54	41
5G-1616	-16 1-11	-16 1-11	56	41
5G-1620	-16 1-11	-20 1.1/4-11	57	50
5G-2020	-20 1.1/4-11	-20 1.1/4-11	57	50

- O-Ring + Retaining, supplied separately if required

5JN
JIC Male x NPT Fixed Female

SAE Specification

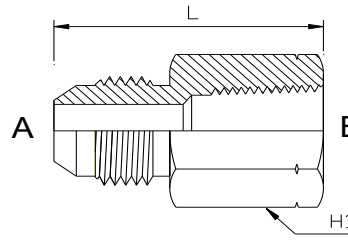

Item No	A-JIC	B-NPT	L	H1
5JN-0502	-05 5/16-24	-02 1/8-27	30	14.3
5JN-0602	-06 3/8-24	-02 1/8-27	30	14.3
5JN-0702	-07 7/16-20	-02 1/8-27	30	14.3
5JN-0704	-07 7/16-20	-04 1/4-18	35	19.0
5JN-0802	-08 1/2-20	-02 1/8-27	30	14.3
5JN-0804	-08 1/2-20	-04 1/4-18	35	19.0
5JN-0902	-09 9/16-18	-02 1/8-27	30	15.9
5JN-0904	-09 9/16-18	-04 1/4-18	36	19.0
5JN-0906	-09 9/16-18	-06 3/8-18	37	22.2
5JN-0908	-09 9/16-18	-08 1/2-14	43	28.6
5JN-1204	-12 3/4-16	-04 1/4-18	39	22.2
5JN-1206	-12 3/4-16	-06 3/8-18	40	22.2
5JN-1208	-12 3/4-16	-08 1/2-14	45	28.6
5JN-1212	-12 3/4-16	-12 3/4-14	48	34.9
5JN-1408	-14 7/8-14	-08 1/2-14	48	28.6
5JN-1412	-14 7/8-14	-12 3/4-14	50	34.9
5JN-1708	-17 1.1/16-12	-08 1/2-14	52	31.8
5JN-1712	-17 1.1/16-12	-12 3/4-14	52	34.9
5JN-1716	-17 1.1/16-12	-16 1-11.5	58	41.3
5JN-2112	-21 1.5/16-12	-12 3/4-14	54	34.9
5JN-2116	-21 1.5/16-12	-16 1-11.5	60	41.3
5JN-2120	-21 1.5/16-12	-20 1.1/4-11.5	62	50.5
5JN-2616	-26 1.5/8-12	-16 1-11.5	63	50.8
5JN-2620	-26 1.5/8-12	-20 1.1/4-11.5	63	50.8
5JN-2624	-26 1.5/8-12	-24 1.1/2-11.5	63	60.3
5JN-3024	-30 1.7/8-12	-24 1.1/2-11.5	67	60.3
5JN-4032	-40 2.1/2-12	-32 2-11.5	75	73.0

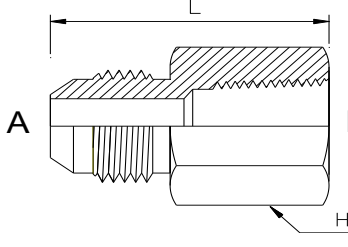
5JT
JIC Male x BSPT Fixed Female

Item No	A-JIC	B-BSPT	L	H1
5JT-0702	-07 7/16-20	-02 1/8-28	30	14
5JT-0704	-07 7/16-20	-04 1/4-19	36	19
5JT-0804	-08 1/2-20	-04 1/4-19	35	19
5JT-0902	-09 9/16-18	-02 1/8-28	33	17
5JT-0904	-09 9/16-18	-04 1/4-19	36	19
5JT-0906	-09 9/16-18	-06 3/8-19	37	22
5JT-0908	-09 9/16-18	-08 1/2-14	43	27
5JT-1206	-12 3/4-16	-06 3/8-19	40	22
5JT-1208	-12 3/4-16	-08 1/2-14	46	27
5JT-1212	-12 3/4-16	-12 3/4-14	51	36
5JT-1408	-14 7/8-14	-08 1/2-14	48	27
5JT-1708	-17 1.1/16-12	-08 1/2-14	52	30
5JT-1712	-17 1.1/16-12	-12 3/4-14	53	36
5JT-2116	-21 1.5/16-12	-16 1-11	60	41

5N
NPT Male x NPT Fixed Female

SAE Specification

	Item No	A-NPT	B-NPT	L	H1
	5N-0202	-02 1/8-27	-02 1/8-27	26	15.9
	5N-0204	-02 1/8-27	-04 1/4-18	31	19.0
	5N-0206	-02 1/8-27	-06 3/8-18	32	22.2
	5N-0404	-04 1/4-18	-04 1/4-18	35	19.0
	5N-0406	-04 1/4-18	-06 3/8-18	37	22.2
	5N-0408	-04 1/4-18	-08 1/2-14	43	28.6
	5N-0412	-04 1/4-18	-12 3/4-14	44	34.9
	5N-0606	-06 3/8-18	-06 3/8-18	37	22.2
	5N-0608	-06 3/8-18	-08 1/2-14	43	28.6
	5N-0806	-08 1/2-14	-06 3/8-18	42	22.2
	5N-0808	-08 1/2-14	-08 1/2-14	47	28.6
	5N-0812	-08 1/2-14	-12 3/4-14	49	34.9
	5N-1208	-12 3/4-14	-08 1/2-14	48	28.6
	5N-1212	-12 3/4-14	-12 3/4-14	49	34.9
	5N-1216	-12 3/4-14	-16 1-11.5	55	41.3
	5N-1612	-16 1-11.5	-12 3/4-14	54	34.9
	5N-1616	-16 1-11.5	-16 1-11.5	60	41.3
	5N-1620	-16 1-11.5	-20 1.1/4-11.5	62	50.8
	5N-1624	-16 1-11.5	-24 1.1/2-11.5	63	60.3
	5N-2016	-20 1.1/4-11.5	-16 1-11.5	61	44.5
	5N-2020	-20 1.1/4-11.5	-20 1.1/4-11.5	63	50.8
	5N-2024	-20 1.1/4-11.5	-24 1.1/2-11.5	64	60.3
	5N-2420	-24 1.1/2-11.5	-20 1.1/4-11.5	65	50.8
	5N-2424	-24 1.1/2-11.5	-24 1.1/2-11.5	64	60.3
	5N-2432	-24 1.1/2-11.5	-32 2-11.5	67	73
	5N-3232	-32 2-11.5	-32 2-11.5	68	73.0

5NO
NPT Male x UNO Female

SAE Specification

	Item No	A-NPT	B-UNO	L	H1
	5NO-0407	-04 1/4-18	-07 7/16-20	33	17.5
	5NO-0409	-04 1/4-18	-09 9/16-18	34	22.2
	5NO-0607	-06 3/8-18	-07 7/16-20	33	17.5
	5NO-0609	-06 3/8-18	-09 9/16-18	34	20.6
	5NO-0612	-06 3/8-18	-12 3/4-16	37	25.4
	5NO-0812	-08 1/2-14	-12 3/4-16	42	27.0
	5NO-0814	-08 1/2-14	-14 7/8-14	44	31.8
	5NO-0817	-08 1/2-14	-17 1.1/16-12	49	34.9
	5NO-1212	-12 3/4-14	-12 3/4-16	42	28.6
	5NO-1214	-12 3/4-14	-14 7/8-14	44	28.6
	5NO-1217	-12 3/4-14	-17 1.1/16-12	49	34.9
	5NO-1221	-12 3/4-14	-21 1.5/16-12	49	41.3
	5NO-1621	-16 1-11.5	-21 1.5/16-12	53	41.3
	5NO-2026	-20 1.1/4-11.5	-26 1.5/8-12	56	54.0

50
UNO Male x UNO Female

SAE Specification

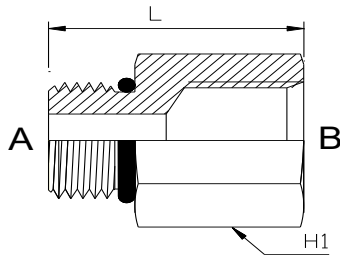

Item No	A-UNO	B-UNO	L	H1
50-0707	-07 7/16-20	-07 7/16-20	27	17.5
50-0709	-07 7/16-20	-09 9/16-18	31	20.6
50-0712	-07 7/16-20	-12 3/4-16	34	27.0
50-0909	-09 9/16-18	-09 9/16-18	29	20.6
50-0912	-09 9/16-18	-12 3/4-16	35	27.0
50-1212	-12 3/4-16	-12 3/4-16	37	27.0
50-1214	-12 3/4-16	-14 7/8-14	40	28.6
50-1217	-12 3/4-16	-17 1.1/16-12	44	34.9
50-1417	-14 7/8-14	-17 1.1/16-12	45	34.9
50-1717	-17 1.1/16-12	-17 1.1/16-12	44	34.9
50-1721	-17 1.1/16-12	-21 1.5/16-12	48	41.3
50-2126	-21 1.5/16-12	-26 1.5/8-12	50	54.0
50-2630	-26 1.5/8-12	-30 1.7/8-12	50	63.5

For Reducing Bush type see 4OR

..... Page 57

50N
UNO Male x NPT Female

SAE Specification

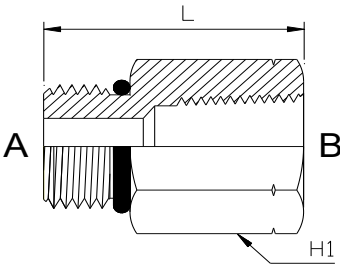

Item No	A-UNO	B-NPT	L	H1
50N-0702	-07 7/16-20	-02 1/8-27	25	14.3
50N-0704	-07 7/16-20	-04 1/4-18	33	19.0
50N-0904	-09 9/16-18	-04 1/4-18	31	19.0
50N-0906	-09 9/16-18	-06 3/8-18	36	22.2
50N-1202	-12 3/4-16	-02 1/8-27	41	28.6
50N-1204	-12 3/4-16	-04 1/4-18	27	22.2
50N-1206	-12 3/4-16	-06 3/8-18	33	22.2
50N-1208	-12 3/4-16	-08 1/2-14	34	28.6
50N-1406	-14 7/8-14	-06 3/8-18	36	25.4
50N-1408	-14 7/8-14	-08 1/2-14	41	28.6
50N-1412	-14 7/8-14	-12 3/4-14	43	34.9
50N-1708	-17 1.1/16-12	-08 1/2-14	38	31.8
50N-1712	-17 1.1/16-12	-12 3/4-14	45	34.9
50N-2112	-21 1.5/16-12	-12 3/4-14	45	38.1
50N-2116	-21 1.5/16-12	-16 1-11.5	53	41.3
50N-2620	-26 1.5/8-12	-20 1.1/4-11.5	58	50.8

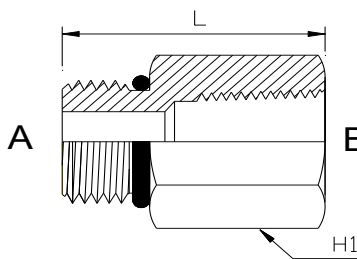
50T
UNO Male x BSPT Female

Item No	A-UNO	B-BSPT	L	H1
50T-0704	-07 7/16-20	-04 1/4-19	31	19
50T-0902	-09 9/16-18	-02 1/8-28	26	17
50T-0904	-09 9/16-18	-04 1/4-19	32	19
50T-1204	-12 3/4-16	-06 3/8-19	33	22
50T-1206	-12 3/4-16	-06 3/8-19	34	22
50T-1208	-12 3/4-16	-08 1/2-14	40	30
50T-1404	-14 7/8-14	-04 1/4-19	36	27
50T-1406	-14 7/8-14	-06 3/8-19	36	27
50T-1408	-14 7/8-14	-08 1/2-14	42	30
50T-1712	-17 1.1/16-12	-12 3/4-14	43	36

5T
BST Male x BSPT Female

Item No	A-BSPT	B-BSPT	L	H1
5T-0202	-02 1/8-28	-02 1/8-28	27	14
5T-0204	-02 1/8-28	-04 1/4-19	33	19
5T-0402	-04 1/4-19	-02 1/8-28	31	16
5T-0404	-04 1/4-19	-04 1/4-19	36	19
5T-0406	-04 1/4-19	-06 3/8-19	38	22
5T-0408	-04 1/4-19	-08 1/2-14	43	27
5T-0606	-06 3/8-19	-06 3/8-19	39	22
5T-0608	-06 3/8-19	-08 1/2-14	44	27
5T-0808	-08 1/2-14	-08 1/2-14	49	27
5T-0812	-08 1/2-14	-12 3/4-14	51	36
5T-0816	-08 1/2-14	-16 1-11	50	41
5T-1212	-12 3/4-14	-12 3/4-14	51	36
5T-1216	-12 3/4-14	-16 1-11	57	41
5T-1612	-16 1-11	-12 3/4-14	58	36
5T-1616	-16 1-11	-16 1-11	60	41
5T-1620	-16 1-11	-20 1.1/4-11	64	50
5T-2020	-20 1.1/4-11	-20 1.1/4-11	65	50
5T-2024	-20 1.1/4-11	-24 1.1/2-11	67	55
5T-2424	-24 1.1/2-11	-24 1.1/2-11	67	55

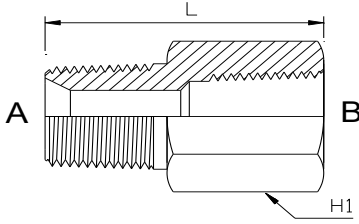
5TN
NPT Male x NPT Female

Item No	A-NPT	B-NPT	L	H1
5TN-0202	-02 1/8-28	-02 1/8-27	26	14
5TN-0404	-04 1/4-19	-04 1/4-18	37	19
5TN-0606	-06 3/8-19	-06 3/8-18	37	22
5TN-0808	-08 1/2-14	-08 1/2-14	49	27
5TN-1212	-12 3/4-14	-12 3/4-14	51	36
5TN-1616	-16 1-11	-16 1-11.5	60	41

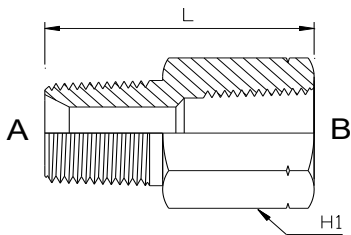
5TO
BSPT Male x UNO Female

Item No	A-BSPT	B-UNO	L	H1
5TO-0414	-04 1/4-19	-14 7/8-14	40	30
5TO-0812	-08 1/2-14	-12 3/4-16	42	27
5TO-0814	-08 1/2-14	-14 7/8-14	44	30

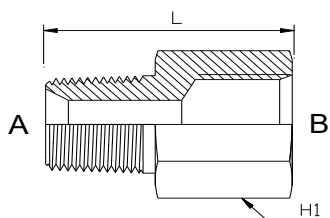

6F
ORFS Male Bulkhead x ORFS Male

SAE Specification

	Item No	A-ORFS	B-ORFS	L	H1	H
	6F-0909	-09 9/16-18	-09 9/16-18	48	20.6	20.6
	6F-1111	-11 11/16-16	-11 11/16-16	53	25.4	25.4
	6F-1313	-13 13/16-16	-13 13/16-16	58	28.6	28.6
	6F-1616	-16 1-14	-16 1-14	67	33.3	33.3
	6F-1919	-19 1.3/16-12	-19 1.3/16-12	69	38.1	38.1
	6F-2323	-23 1.7/16-12	-23 1.7/16-12	69	44.5	44.5
	6F-2727	-27 1.11/16-12	-27 1.11/16-12	70	50.8	50.8
	6F-3232	-32 2-12	-32 2-12	70	60.3	60.3

6FG
ORFS Male Bulkhead x BSPP Male

Encapsulated Seal

	Item No	A-ORFS	B-BSPP	L	H1	H
	6FG-0904	-09 9/16-18	-04 1/4-19			
	6FG-1106	-11 11/16-16	-06 3/8-19			
	6FG-1308	-13 13/16-16	-08 1/2-14			

6FO
ORFS Male Bulkhead x UNO Male

SAE Specification

	Item No	A-ORFS	B-UNO	L	H
	6FO-0907	-11 11/16-16	-09 9/16-18	54	20.6
	6FO-1109	-11 11/16-16	-09 9/16-18	59	25.4
	6FO-1312	-13 13/16-16	-12 3/4-12	66	28.6
	6FO-1614	-16 1-14	-14 7/8-14	74	33.3
	6FO-1917	-19 1.3/16-12	-17 1.1/16-12	79	38.1
	6FO-2321	-23 1.7/16-12	-21 1.5/8-12	82	44.5

6G
BSPP Male Bulkhead x BSPP Male

Encapsulated Seal

	Item No	A-BSPP	B-BSPP	L	H1	H
	6G-0202	-02 1/8-28	-02 1/8-28	43	14	14
	6G-0404	-04 1/4-19	-04 1/4-19	51	19	19
	6G-0404R	-04 1/4-19	-04 1/4-19	51	19	19
	6G-0606	-06 3/8-19	-06 3/8-19	54	22	22
	6G-0808	-08 1/2-14	-08 1/2-14	67	27	27
	6G-1212	-12 3/4-14	-12 3/4-14	67	32	32
	6G-1616	-16 1-11	-16 1-11	74	41	41
	6G-1616R	-16 1-11	-16 1-11	74	41	41
	6G-2020	-20 1.1/4-11	-20 1.1/4-11	81	50	50
	6G-2020R	-20 1.1/4-11	-20 1.1/4-11	81	50	50
	6G-2424	-24 1.1/2-11	-24 1.1/2-11	85	55	55
	6G-2424R	-24 1.1/2-11	-24 1.1/2-11	85	55	55
	6G-3232	-32 2-11	-32 2-11	108	70	70
	6G-3232R	-32 2-11	-32 2-11	108	70	70

6J
JIC Male Bulkhead x JIC Male

SAE Specification

	Item No	A-JIC	B-JIC	L	H1	H
	6J-0707	-07 7/16-20	-07 7/16-20	53	17.5	17.5
	6J-0808	-08 1/2-20	-08 1/2-20	53	19.1	19.1
	6J-0909	-09 9/16-18	-09 9/16-18	55	20.6	20.6
	6J-1212	-12 3/4-16	-12 3/4-16	62	25.4	25.4
	6J-1414	-14 7/8-14	-14 7/8-14	70	28.6	28.6
	6J-1717	-17 1.1/16-12	-17 1.1/16-12	78	34.9	34.9
	6J-2121	-21 1.5/16-12	-21 1.5/16-12	80	41.3	41.3
	6J-2626	-26 1.5/8-12	-26 1.5/8-12	84	47.6	47.6
	6J-3030	-30 1.7/8-12	-30 1.7/8-12	89	54.0	54.0
	6J-4040	-40 2.1/2-12	-40 2.1/2-12	107	69.9	69.9

6JG
JIC Male Bulkhead x BSPP Male

	Item No	A-JIC	B-BSPP	L	H1	H
	6JG-0704	-07 7/16-20	-04 1/4-19	51	19	19
	6JG-0906	-09 9/16-18	-06 3/8-19	56	22	22
	6JG-0906R	-09 9/16-18	-06 3/8-19	56	22	22
	6JG-1206R	-12 3/4-16	-06 3/8-19	57	24	24
	6JG-1208	-12 3/4-16	-08 1/2-14	62	24	24
	6JG-1208R	-12 3/4-16	-08 1/2-14	62	24	24
	6JG-1408R	-14 7/8-14	-08 1/2-14	65	30	30
	6JG-1712	-17 1.1/16-12	-12 3/4-14	74	32	32
	6JG-1712R	-17 1.1/16-12	-12 3/4-14	71	32	32
	6JG-2116	-21 1.5/16-12	-16 1-11	80	41	41

Note - "R" suffix is O-ring + Retaining Ring type

6JN
JIC Male Bulkhead x NPT Male

SAE Specification

	Item No	A-JIC	B-NPT	L	H1	H
	6JN-0704	-07 7/16-20	-04 1/4-18	54	17.5	17.5
	6JN-0906	-09 9/16-18	-06 3/8-18	56	20.6	20.6
	6JN-1208	-12 3/4-16	-08 1/2-14	66	25.4	25.4
	6JN-1408	-14 7/8-14	-08 1/2-14	70	28.6	28.6
	6JN-1712	-17 1.1/16-12	-12 3/4-14	76	34.9	34.9
	6JN-2116	-21 1.5/16-12	-16 1-11.5	81	41.3	41.3

6JNF
JIC Male Bulkhead x NPT Female

SAE Specification

	Item No	A-JIC	B-NPT	L	H1	H
	6JNF-0702	-07 7/16-20	-02 1/8-27	48	17.5	17.5
	6JNF-0704	-07 7/16-20	-04 1/4-18	53	19.1	19.1
	6JNF-0706	-07 7/16-20	-06 3/8-18	55	22.2	22.2
	6JNF-0904	-09 9/16-18	-04 1/4-18	55	20.6	20.6
	6JNF-0906	-09 9/16-18	-06 3/8-18	57	22.2	22.2
	6JNF-1208	-12 3/4-16	-08 1/2-14	67	28.6	28.6
	6JNF-1408	-14 7/8-14	-08 1/2-14	70	28.6	28.6
	6JNF-1712	-17 1.1/16-12	-12 3/4-14	76	34.9	34.9

6JT

JIC Male Bulkhead x BSPT Male

	Item No	A-JIC	B-BSPT	L	H1	H
	6JT-0706	-07 7/16-20	-06 3/8-19	54	22	22
	6JT-0906	-09 9/16-18	-06 3/8-19	56	22	22
	6JT-1208	-12 3/4-16	-08 1/2-14	66	25.4	25.4
	6JT-1416	-14 7/8-14	-16 1-12	80	36	36

6JTF

JIC Male Bulkhead x BSPT Female

	Item No	A-JIC	B-BSPT	L	H1	H
	6JTF-0702	-07 7/16-20	-02 1/8-28	47	14	14
	6JTF-0704	-07 7/16-20	-04 1/4-19	54	19	19

4F
ORFS Plug

SAE Specification

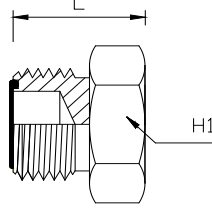

Item No	A-ORFS	L	H1
4F-09	-09 9/16-18	17	15.8
4F-11	-11 11/16-16	19	19.1
4F-13	-13 13/16-16	22	22.2
4F-16	-16 1-14	26	27.0
4F-19	-19 1.3/16-12	27	31.8
4F-23	-23 1.7/16-12	28	38.1
4F-27	-27 1.11/16-12	28	44.5
4F-32	-32 2-11	28	54.0

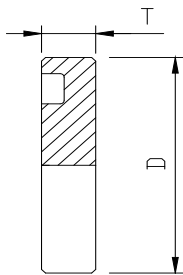
4FL
SAE Flange Plug CD61

Item No	A-SAE F	T	D
4FL-08	-08 1/2	6.7	30.2
4FL-12	-12 3/4	6.7	38.1
4FL-16	-16 1	8.0	44.5
4FL-20	-20 1.1/4	8.0	50.8
4FL-24	-24 1.1/2	8.0	60.3
4FL-32	-32 2	9.5	71.4
4FL-40	-40 2.1/2	9.5	84.1
4FL-48	-48 3	9.5	101.6

- For use with SAE Code 61 Flange Clamps
 - Not for use in full pressure applications. For full pressure see FSBB-

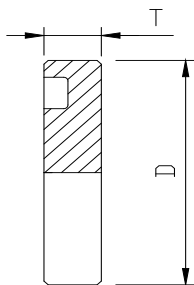
4FLH
SAE Flange Plug CD62

Item No	A-SAE F	T	D
4FLH-08	-08 1/2	7.8	31.8
4FLH-12	-12 3/4	8.8	41.3
4FLH-16	-16 1	9.5	47.6
4FLH-20	-20 1.1/4	10.3	54.0
4FLH-24	-24 1.1/2	12.6	63.5
4FLH-32	-32 2	12.6	79.4

- For use with SAE Code 62 Flange Clamps
 - Not for use in full pressure applications. For full pressure see FSBBH-

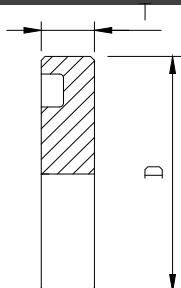
4FLHC
SAE Flange Plug CAT

Item No	A-SAE F	T	D
4FLHC-12	-12 3/4	14.2	41.3
4FLHC-16	-16 1	14.2	47.6
4FLHC-20	-20 1.1/4	14.2	54.0
4FLHC-24	-24 1.1/2	14.2	63.5
4FLHC-32	-32 2	14.2	79.4

- For use with SAE Code 62 Flange Clamps
 - Not for use in full pressure applications. For full pressure see FSBBH-

4G
BSPP Plug

Encapsulated Seal Type

Item No	A-BSPP	L	H1
4G-02	-02 1/8-28	16	14
4G-04	-04 1/4-19	20	19
4G-06	-06 3/8-19	23	22
4G-08	-08 1/2-14	25	27
4G-12	-12 3/4-14	29	32
4G-16	-16 1-11	35	41
4G-20	-20 1.1/4-11	37	50
4G-24	-24 1.1/2-11	40	55
4G-32	-32 2-11	40	75

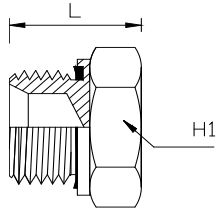
4G*R
BSPP Plug

O-Ring + Retaining Ring Type

Item No	A-BSPP	L	H1
4G-02R	-02 1/8-28	16	14
4G-04R	-04 1/4-19	20	19
4G-06R	-06 3/8-19	23	22
4G-08R	-08 1/2-14	25	27
4G-12R	-12 3/4-14	29	32
4G-16R	-16 1-11	35	41
4G-20R	-20 1.1/4-11	37	50
4G-24R	-24 1.1/2-11	40	55
4G-32R	-32 2-11	40	75

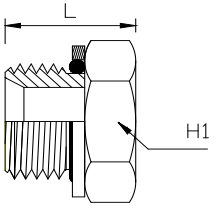

- Standard Encapsulated Seal type
- "R" suffix for O-ring + Retaining Ring type

4G-N
BSPP Socket Head Plug

Encapsulated Seal

Item No	A-BSPP	L	D
4G-N-02	-02 1/8-28	12	14
4G-N-04	-04 1/4-19	17	19
4G-N-06	-06 3/8-19	17	22
4G-N-08	-08 1/2-14	19	27
4G-N-12	-12 3/4-14	21	32
4G-N-16	-16 1-11	22	40
4G-N-20	-20 1.1/4-11	22	50
4G-N-24	-24 1.1/2-11	22	55
4G-N-32	-32 2-11	25	70

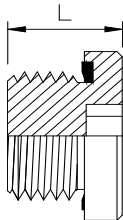

4J
JIC Plug

SAE Specification

	Item No	A-JIC	L	H1
	4J-05	-05 5/16-24	19	11.1
	4J-06	-06 3/8-24	19	11.1
	4J-07	-07 7/16-20	20	12.7
	4J-08	-08 1/2-20	20	14.3
	4J-09	-09 9/16-18	21	15.9
	4J-12	-12 3/4-16	24	20.6
	4J-14	-14 7/8-14	28	23.8
	4J-17	-17 1.1/16-12	33	28.6
	4J-19	-19 1.3/16-12	33	31.8
	4J-21	-21 1.5/16-12	34	34.9
	4J-26	-26 1.5/8-12	37	42.9
	4J-30	-30 1.7/8-12	42	51.8
	4J-40	-40 2.1/2-12	52	66.7

4K
JIS Metric (Komatsu) Plug

	Item No	A-JIS	L	H1
	4K-12	-12 M12x1.5	23	17
	4K-14	-14 M14x1.5	23	17
	4K-16	-16 M16x1.5	24	17
	4K-18	-18 M18x1.5	25	19
	4K-20	-20 M20x1.5	28	22
	4K-22	-22 M22x1.5	28	24
	4K-24	-24 M24x1.5	32	27
	4K-30	-30 M30x1.5	37	32
	4K-33	-33 M33x1.5	41	36
	4K-36	-36 M36x1.5	46	41

4M*ES
Metric Encapsulated Seal Plug

	Item No	A-Metric	L	H1
	4M-10ES	-10 M10x1.0	15	14
	4M-12ES	-12 M12x1.5	17	17
	4M-14ES	-14 M14x1.5	19	19
	4M-16ES	-16 M16x1.5	20	22
	4M-18ES	-18 M18x1.5	20	24
	4M-20ES	-20 M20x1.5	23	27
	4M-22ES	-22 M22x1.5	23	27

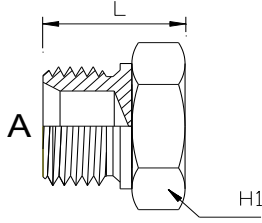
4M
Metric Plug

Item No	A-Metric	L	H1
4M-10	-10 M10x1.0	15	14
4M-12	-12 M12x1.5	17	17
4M-14	-14 M14x1.5	19	19
4M-16	-16 M16x1.5	20	22
4M-18	-18 M18x1.5	20	24
4M-20	-20 M20x1.5	23	27
4M-22	-22 M22x1.5	23	27
4M-24	-24 M24x1.5	25	30
4M-26	-26 M26x1.5	28	32
4M-27-1.5	-27 M27x1.5	28	32
4M-27	-27 M27x2.0	28	32
4M-28	-28 M28x1.5	28	32
4M-30-1.5	-30 M30x1.5	30	36
4M-30	-30 M30x2.0	30	36
4M-33x1.5	-33 M33x1.5	35	41
4M-33	-33 M33x2.0	35	41
4M-36	-36 M36x2.0	35	46
4M-38x1.5	-38 M38x1.5	36	50
4M-38x2.0	-38 M38x2.0	36	50
4M-42	-42 M42x2.0	37	50
4M-52	-52 M52x2.0	40	60

4M-N
Metric Socket Head Plug

Encapsulated Seal Type

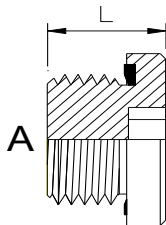

Item No	A-Metric	L	D
4M-N-08	-08 M08x1.0	12	12
4M-N-10	-10 M10x1.0	12	14
4M-N-12	-12 M12x1.5	17	17
4M-N-14	-14 M14x1.5	17	19
4M-N-16	-16 M16x1.5	17	22
4M-N-18	-18 M18x1.5	17	24
4M-N-20	-20 M20x1.5	19	26
4M-N-22	-22 M22x1.5	19	27
4M-N-24	-24 M24x1.5	19	29
4M-N-26	-26 M26x1.5	21	32
4M-N-27-1.5	-27 M27x1.5	21	32
4M-N-30	-30 M30x2.0	22	37
4M-N-33	-33 M33x2.0	22	40
4M-N-42	-42 M42x2.0	22	40

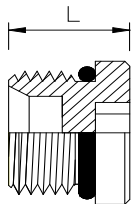
4M-N * O
Metric Socket Head Plug O-ring Type

Item No	A-Metric	L	D
4M-N-10O	-10 M10x1.0	12	14
4M-N-12O	-12 M12x1.5	17	17
4M-N-14O	-14 M14x1.5	17	19
4M-N-16O	-16 M16x1.5	17	22
4M-N-18O	-18 M18x1.5	17	24

4N
NPT Plug

SAE Specification

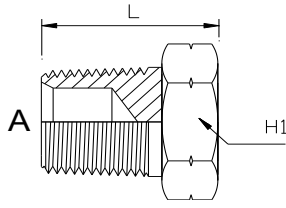

Item No	A-NPT	L	H1
4N-02	-02 1/8-27	15	11.1
4N-04	-04 1/4-18	19	14.3
4N-06	-06 3/8-18	20	17.5
4N-08	-08 1/2-14	28	22.2
4N-12	-12 3/4-14	30	28.6
4N-16	-16 1-11.5	35	34.9
4N-20	-20 1.1/4-11.5	38	44.5
4N-24	-24 1.1/2-11.5	40	50.8
4N-32	-32 2-11.5	44	63.5

4N-N
NPT Socket Head Plug

SAE Specification

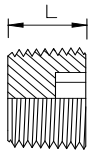

Item No	A-NPT	L
4N-N-02	-02 1/8-27	8
4N-N-04	-04 1/4-18	12
4N-N-06	-06 3/8-18	12
4N-N-08	-08 1/2-14	15
4N-N-12	-12 3/4-14	16
4N-N-16	-16 1-11.5	20
4N-N-20	-20 1.1/4-11.5	22
4N-N-24	-24 1.1/2-11.5	23

40
UNO Plug

SAE Specification

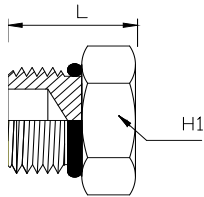

Item No	A-UNO	L	H1
40-05	-05 5/16-24	15	11.1
40-06	-06 3/8-24	15	12.7
40-07	-07 7/16-20	16	14.3
40-08	-08 1/2-20	16	15.8
40-09	-09 9/16-18	18	17.5
40-12	-12 3/4-16	20	22.2
40-14	-14 7/8-14	23	25.4
40-17	-17 1.1/16-12	27	28.6
40-19	-19 1.3/16-12	27	34.9
40-21	-21 1.5/-16-12	28	38.1
40-26	-26 1.5/8-12	30	47.6
40-30	-30 1.7/8-12	30	54.0
40-40	-40 2.1/2-11	32	69.9

40-N
UNO Socket Head Plug

SAE Specification

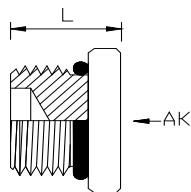

Item No	A-UNO	L	AK
40-N-05	-05 5/16-24	10	3.18
40-N-06	-06 3/8-24	10	3.18
40-N-07	-07 7/16-20	12	4.78
40-N-08	-08 1/2-20	12	4.78
40-N-09	-09 9/16-18	13	6.35
40-N-12	-12 3/4-16	15	7.92
40-N-14	-14 7/8-14	17	9.53
40-N-17	-17 1.1/16-12	20	14.27
40-N-21	-21 1.5/16-12	20	15.88
40-N-26	-26 1.5/8-12	20	19.05
40-N-30	-30 1.7/8-12	20	19.05
40-N-40	-40 2.1/2-12	20	19.05

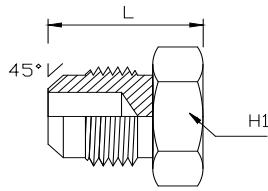
4P
SAE 45 Degree Plug

Item No	A-SAE	L	H1
4P-07	-07 7/16-20	18	12
4P-08	-08 1/2-20	20	14
4P-10	-10 5/8-18	22	16
4P-12	-12 3/4-16	27	24
4P-14	-14 7/8-14	31	27
4P-17	-17 1.1/16-14	34	30

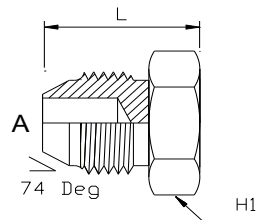
4Q
Metric 37 Degree Plug

Item No	A-Metric	L	H1
4Q-12	-12 M12x1.5	22	14
4Q-14	-14 M14x1.5	23	17
4Q-16	-16 M16x1.5	24	17
4Q-18	-18 M18x1.5	24	19
4Q-22	-22 M22x1.5	28	24
4Q-24	-24 M24x1.5	30	27
4Q-27	-27 M27x1.5	30	30
4Q-30	-30 M30x1.5	34	32

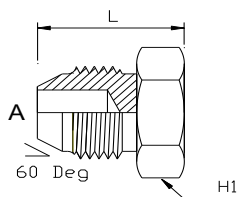
4S
JIS (BSP) Plug

Item No	A-JIS	L	H1
4S-02	-02 1/8-28	22	12
4S-04	-04 1/4-19	23	14
4S-06	-06 3/8-19	24	17
4S-08	-08 1/2-14	30	22
4S-12	-12 3/4-14	30	27
4S-16	-16 1-11	35	36

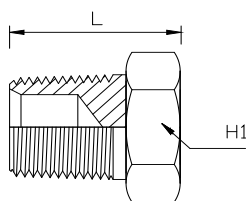
4T
BSPT Plug

Item No	A-BSPT	L	H1
4T-02	-02 1/8-28	16	12
4T-04	-04 1/4-19	20	14
4T-06	-06 3/8-19	21	17
4T-08	-08 1/2-14	27	22
4T-10	-10 5/8-18	28	24
4T-12	-12 3/4-14	29	27
4T-16	-16 1-11	37	36
4T-20	-20 1.1/4-11	39	46
4T-24	-24 1.1/2-11	42	50
4T-32	-32 2-11	47	65

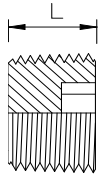
4T-N
BSPT Socket Head Plug

Item No	A-BSPT	L
4T-N-02	-02 1/8-28	8
4T-N-04	-04 1/4-19	12
4T-N-06	-06 3/8-19	12
4T-N-08	-08 1/2-14	15
4T-N-12	-12 3/4-14	16
4T-N-16	-16 1-11	20
4T-N-20	-20 1.1/4-11	

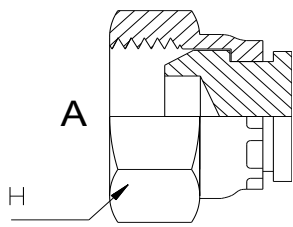
9B
BSP Cap

Item No	A-BSP	L	H
9B-02	-02 1/8-28	6	14
9B-04	-04 1/4-19	6	19
9B-06	-06 3/8-19	6	22
9B-08	-08 1/2-14	8	27
9B-10	-10 5/8-14	10	30
9B-12	-12 3/4-14	11	32
9B-16	-16 1-11	12	41 *
9B-20	-20 1.1/4-11	11	50 *
9B-24	-24 1.1/2-11	13	55 *
9B-32	-32 2-11	16	70 *

9F
ORFS Cap

SAE Specification

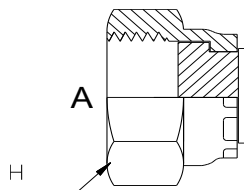

Item No	A-ORFS	H
9F-09	-09 9/16-18	17.5
9F-11	-11 11/16-16	20.6
9F-13	-13 13/16-16	23.8
9F-16	-16 1-14	28.6
9F-19	-19 1.3/16-12	34.9
9F-23	-23 1.7/16-12	41.3
9F-27	-27 1.11/16-12	47.6
9F-32	-32 2-11	57.2

9J*CAP
JIC Cap

SAE Specification

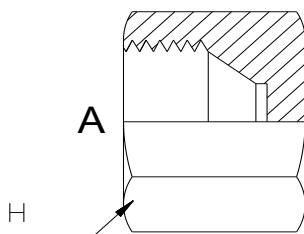

Item No	A-JIC	L	H
9J-06-CAP	-06 3/8-20	14	11.1
9J-07-CAP	-07 7/16-20	15	14.3
9J-08-CAP	-08 1/2-20	16	15.9
9J-09-CAP	-09 9/16-18	16	17.5
9J-12-CAP	-12 3/4-16	19	22.2
9J-14-CAP	-14 7/8-14	21	25.4
9J-17-CAP	-17 1.1/16-12	23	31.8
9J-19-CAP	-19 1.3/16-12	25	34.9
9J-21-CAP	-21 1.5/16-12	26	38.1
9J-26-CAP	-26 1.5/8-16	27	50.8
9J-30-CAP	-30 1.7/8-12	30	57.2
9J-40-CAP	-40 2.1/2-12	37	73.0

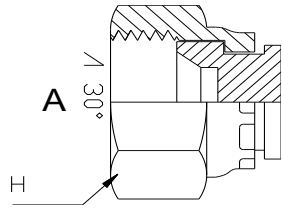
9K
JIS Metric (Komatsu) Cap

Item No	A-JIS	H
9K-12	-12 M12x1.5	17
9K-14	-14 M14x1.5	19
9K-16	-16 M16x1.5	22
9K-18	-18 M18x1.5	24
9K-20	-16 M20x1.5	27
9K-22	-22 M22x1.5	27
9K-24	-24 M24x1.5	32
9K-30	-30 M30x1.5	36
9K-33	-33 M33x1.5	41
9K-36	-36 M36x1.5	46

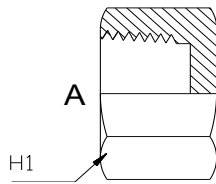
9N
NPT Cap

Item No	A-NPT	H
9N-02	-02 1/8-27	14.3
9N-04	-04 1/4-18	17.5
9N-06	-06 3/8-18	22.2
9N-08	-08 1/2-14	25.4
9N-12	-12 3/4-14	31.8
9N-16	-16 1-11.5	38.1

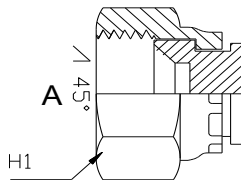
9P
SAE 45 Degree Cap

Item No	A-SAE	H
9P-07	-07 7/16-20	14.3
9P-08	-08 1/2-20	15.9
9P-10	-10 5/8-18	20.6
9P-12	-12 3/4-16	22.2
9P-14	-14 7/8-14	25.4
9P-17	-17 1.1/16-14	31.8

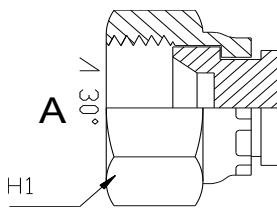
9S
JIS (BSP) Cap

Item No	A-JIS	H
9S-04	-04 1/4-19	19
9S-06	-06 3/8-19	22
9S-08	-08 1/2-14	27
9S-12	-12 3/4-14	32
9S-16	-16 1-11	38

4GR
BSPP Reducing Bush

Encapsulated Seal Type

	Item No	A-BSPP	B-BSPP	L	H1
	4GR-0402	-04 1/4-19	-02 1/8-28	26	19
	4GR-0602	-06 3/8-19	-02 1/8-28	22	22
	4GR-0604	-06 3/8-19	-04 1/4-19	34	22
	4GR-0802	-08 1/2-14	-02 1/8-28	27	27
	4GR-0804	-08 1/2-14	-04 1/4-19	27	27
	4GR-0806	-08 1/2-14	-06 3/8-19	36	27
	4GR-1204	-12 3/4-14	-04 1/4-19	29	32
	4GR-1206	-12 3/4-14	-06 3/8-19	29	32
	4GR-1208	-12 3/4-14	-08 1/2-14	46	32
	4GR-1606	-16 1-11	-06 3/8-19	35	41
	4GR-1608	-16 1-11	-08 1/2-14	35	41
	4GR-1612	-16 1-11	-12 3/4-14	51	41
	4GR-2012	-20 1.1/4-11	-12 3/4-14	38	50
	4GR-2016	-20 1.1/4-11	-16 1-11	47	50
	4GR-2412	-24 1.1/2-11	-12 3/4-14	40	55
	4GR-2416	-24 1.1/2-11	-16 1-11	40	55
	4GR-2420	-24 1.1/2-11	-20 1.1/4-11	53	55
	4GR-3216	-32 2-11	-16 1-11	55	70
	4GR-3220	-32 2-11	-20 1.1/4-11	55	70
	4GR-3224	-32 2-11	-24 1.1/2-11	55	70

4GR R
BSPP Reducing Bush

O-Ring + Retaining Ring Type

	Item No	A-BSPP	B-BSPP	L	H1
	4GR-0402R	-04 1/4-19	-02 1/8-28	26	19
	4GR-0604R	-06 3/8-19	-04 1/4-19	34	22
	4GR-0804R	-08 1/2-14	-04 1/4-19	27	27
	4GR-0806R	-08 1/2-14	-06 3/8-19	36	27
	4GR-1204R	-12 3/4-14	-04 1/4-19	29	32
	4GR-1206R	-12 3/4-14	-06 3/8-19	29	32
	4GR-1208R	-12 3/4-14	-08 1/2-14	46	32
	4GR-1608R	-16 1-11	-08 1/2-14	35	41
	4GR-1612R	-16 1-11	-12 3/4-14	51	41
	4GR-2008R	-20 1.1/4-11	-08 1/2-14	38	50
	4GR-2012R	-20 1.1/4-11	-12 3/4-14	38	50
	4GR-2016R	-20 1.1/4-11	-16 1-11	47	50
	4GR-2416R	-24 1.1/2-11	-16 1-11	40	55
	4GR-2420R	-24 1.1/2-11	-20 1.1/4-11	53	55

- Standard Encapsulated Seal type

- "R" suffix for O-ring + Retaining Ring type

4NR
NPT Reducing Bush

SAE Specification

	Item No	A-NPT	B-NPT	L	H1
	4NR-0402	-04 1/4-18	-02 1/8-27	22	15.9
	4NR-0602	-06 3/8-18	-02 1/8-27	22	19.1
	4NR-0604	-06 3/8-19	-04 1/4-18	22	19.1
	4NR-0802	-08 1/2-14	-02 1/8-27	28	22.2
	4NR-0804	-08 1/2-14	-04 1/4-18	28	22.2
	4NR-0806	-08 1/2-14	-06 3/8-18	28	22.2
	4NR-1202	-12 3/4-14	-02 1/8-27	30	28.6
	4NR-1204	-12 3/4-14	-04 1/4-18	30	28.6
	4NR-1206	-12 3/4-14	-06 3/8-18	30	28.6
	4NR-1208	-12 3/4-14	-08 1/2-14	30	28.6
	4NR-1604	-16 1-11.5	-04 1/4-18	35	34.9
	4NR-1606	-16 1-11.5	-06 3/8-18	35	34.9
	4NR-1608	-16 1-11.5	-08 1/2-14	35	34.9
	4NR-1612	-16 1-11.5	-12 3/4-14	35	34.9
	4NR-2006	-20 1.1/4-11.5	-06 3/8-18	37	44.5
	4NR-2008	-20 1.1/4-11.5	-08 1/2-14	37	44.5
	4NR-2012	-20 1.1/4-11.5	-12 3/4-14	37	44.5
	4NR-2016	-20 1.1/4-11.5	-16 1-11.5	37	44.5
	4NR-2408	-24 1.1/2-11.5	-08 1/2-14	40	50.8
	4NR-2412	-24 1.1/2-11.5	-12 3/4-14	40	50.8
	4NR-2416	-24 1.1/2-11.5	-16 1-11.5	40	50.8
	4NR-2420	-24 1.1/2-11.5	-20 1.1/4-11.5	40	50.8
	4NR-3212	-32 2-11.5	-12 3/4-14	45	63.5
	4NR-3216	-32 2-11.5	-16 1-11.5	45	63.5
	4NR-3220	-32 2-11.5	-20 1.1/4-11.5	45	63.5
	4NR-3224	-32 2-11.5	-24 1.1/2-11.5	45	63.5
	4NR-4032	-40 2.1/2-8	-32 2-11.5	60	75

4OR
UNO Reducing Bush

SAE Specification

	Item No	A-UNO	B-UNO	L	H1
	4OR-0907	-09 9/16-18	-07 7/16-20	31	20.6
	4OR-1207	-12 3/4-16	-07 7/16-20	34	27.0
	4OR-1209	-12 3/4-16	-09 9/16-18	35	27.0
	4OR-1407	-14 7/8-14	-07 7/16-20	35	27.0
	4OR-1409	-14 7/8-14	-09 9/16-18	35	27.0
	4OR-1412	-14 7/8-14	-12 3/4-16	40	28.6
	4OR-1707	-17 1.1/16-12	-07 7/16-20	44	34.9
	4OR-1709	-17 1.1/16-12	-09 9/16-18	44	34.9
	4OR-1712	-17 1.1/16-12	-12 3/4-16	44	34.9
	4OR-1714	-17 1.1/16-12	-14 7/8-14	45	34.9
	4OR-2107	-21 1.5/16-12	-07 7/16-20	45	41.3
	4OR-2109	-21 1.5/16-12	-09 9/16-18	45	41.3
	4OR-2112	-21 1.5/16-12	-12 3/4-16	45	41.3
	4OR-2114	-21 1.5/16-12	-14 7/8-14	45	41.3
	4OR-2117	-21 1.5/16-12	-17 1.1/16-12	48	41.3
	4OR-2612	-26 1.5/8-12	-12 3/4-16	49	54.0
	4OR-2614	-26 1.5/8-12	-14 7/8-14	49	54.0
	4OR-2617	-26 1.5/8-12	-17 1.1/16-12	49	54.0
	4OR-2621	-26 1.5/8-12	-21 1.5/16-12	50	54.0
	4OR-3017	-30 1.7/8-12	-17 1.1/16-12	50	63.5
	4OR-3021	-30 1.7/8-12	-21 1.5/16-12	50	63.5
	4OR-3026	-30 1.7/8-12	-26 1.5/8-12	50	63.5
	4OR-4026	-40 2.1/2-12	-26 1.5/8-12	50	69.9
	4OR-4030	-40 2.1/2-12	-30 1.7/8-12	50	69.9

* For Male Female expander see 50

Page 43

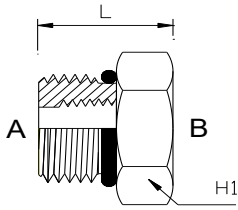
40TR
UNO to BSPT Reducing Bush

Item No	A-UNO	B-BSPT	L	H1
40TR-0902	-09 9/16-18	-02 1/8-28	26	19
40TR-1204	-12 3/4-16	-04 1/4-19	33	22
40TR-1404	-14 7/8-14	-04 1/4-19	34	27
40TR-1708	-17 1.1/16-12	-08 1/2-14	44	32
40TR-2108	-21 1.5/16-12	-08 1/2-14	44	38
40TR-2112	-21 1.5/16-12	-12 3/4-14	45	38
40TR-2616	-26 1.5/8-12	-12 3/4-14	42	48

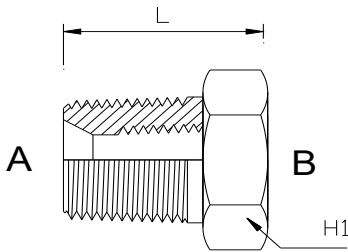
4TR
BSPT Reducing Bush

Item No	A-BSPT	B-BSPT	L	H1
4TR-0402	-04 1/4-19	-02 1/8-28	21	14
4TR-0602	-06 3/8-19	-02 1/8-28	22	19
4TR-0604	-06 3/8-19	-04 1/4-19	22	19
4TR-0802	-08 1/2-14	-02 1/8-28	28	22
4TR-0804	-08 1/2-14	-04 1/4-19	28	22
4TR-0806	-08 1/2-14	-06 3/8-19	28	22
4TR-1204	-12 3/4-14	-04 1/4-19	29	30
4TR-1206	-12 3/4-14	-06 3/8-19	29	30
4TR-1208	-12 3/4-14	-08 1/2-14	29	30
4TR-1604	-16 1-11	-04 1/4-19	34	36
4TR-1606	-16 1-11	-06 3/8-19	34	36
4TR-1608	-16 1-11	-08 1/2-14	34	36
4TR-1612	-16 1-11	-12 3/4-14	34	36
4TR-2008	-20 1.1/4-11	-08 1/2-14	37	46
4TR-2012	-20 1.1/4-11	-12 3/4-14	38	46
4TR-2016	-20 1.1/4-11	-16 1-11	38	45
4TR-2408	-24 1.1/2-11	-08 1/2-14	40	50
4TR-2412	-24 1.1/2-11	-12 3/4-14	40	50
4TR-2416	-24 1.1/2-11	-16 1-11	40	50
4TR-2420	-24 1.1/2-11	-20 1.1/4-11	40	50
4TR-3216	-32 2-11	-16 1-11	45	65
4TR-3220	-32 2-11	-20 1.1/4-11	45	65
4TR-3224	-32 2-11	-24 1.1/2-11	45	65

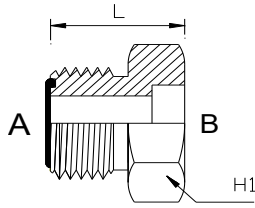
4FW
ORFS Male Tube Weld

Item No	A-ORFS	B-Tube	L	H1
4FW-0904	-09 9/16-18	-04 1/4	22	15.9
4FW-0906	-09 9/16-18	-06 3/8	22	15.9
4FW-1106	-11 11/16-18	-06 3/8	23	19.1
4FW-1308	-13 13/16-16	-08 1/2	25	22.2
4FW-1610	-16 1-14	-10 5/8	27	27.0
4FW-1912	-19 1.3/16-12	-12 3/4	34	31.8
4FW-1916	-19 1.3/16-12	-16 1	35	31.8
4FW-2316	-23 1.7/16-12	-16 1	39	38.1
4FW-2320	-23 1.7/16-12	-20 1.1/4		

Note - Supplied without O-rings.

Available seperately. See OR-F-** page -

115

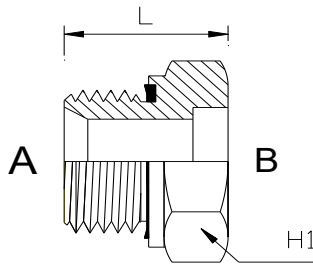
4GW
BSPP Male Tube Weld

Item No	A-BSPP	B-Tube	L	H1
4GW-0404	-04 1/4-19	-04 1/4	20	19
4GW-0406	-04 1/4-19	-06 3/8	20	19
4GW-0606	-06 3/8-19	-06 3/8	23	22
4GW-0608	-06 3/8-19	-08 1/2	25	22
4GW-0808	-08 1/2-14	-08 1/2	25	27
4GW-0810	-08 1/2-14	-10 5/8	25	27
4GW-0812	-08 1/2-14	-12 3/4	25	27
4GW-1212	-12 3/4-14	-12 3/4	29	32
4GW-1216	-12 3/4-14	-16 1	29	32
4GW-1616	-16 1-11	-16 1	35	41
4GW-1620	-16 1-11	-20 1.1/4	35	41
4GW-2020	-20 1.1/4-11	-20 1.1/4	37	50
4GW-2420	-24 1.1/2-11	-20 1.1/4	40	55

4JW
JIC Male Tube Weld

SAE Specification

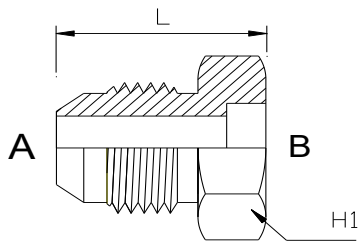

Item No	A-JIC	B-Tube	L	H1
4JW-0704	-07 7/16-20	-04 1/4		12.7
4JW-0706	-07 7/16-20	-06 3/8		14.3
4JW-0904	-09 9/16-18	-04 1/4		15.9
4JW-0906	-09 9/16-18	-06 3/8		15.9
4JW-0908	-09 9/16-18	-08 1/2		20.6
4JW-1206	-12 3/4-16	-06 3/8		20.6
4JW-1208	-12 3/4-16	-08 1/2		20.6
4JW-1210	-12 3/4-16	-10 5/8		23.8
4JW-1212	-12 3/4-16	-12 3/4		23.8
4JW-1408	-14 7/8-14	-08 1/2		23.8
4JW-1410	-14 7/8-14	-10 5/8		23.8
4JW-1412	-14 7/8-14	-12 3/4		31.8
4JW-1710	-17 1.1/16-12	-10 5/8		31.8
4JW-1712	-17 1.1/16-12	-12 3/4		31.8
4JW-1716	-17 1.1/16-12	-16 1		31.8
4JW-2116	-21 1.5/16-12	-16 1		34.9
4JW-2120	-21 1.5/16-12	-20 1.1/4		42.9
4JW-2124	-21 1.5/16-12	-24 1.1/2		42.9
4JW-2620	-26 1.5/8-12	-20 1.1/4		42.9
4JW-2624	-26 1.5/8-12	-24 1.1/2		50.8
4JW-3024	-30 1.7/8-12	-24 1.1/2		50.8
4JW-4032	-40 2.1/2-12	-32 2		66.7

4JW9
JIC Male 90 Degree Tube Weld

SAE Specification

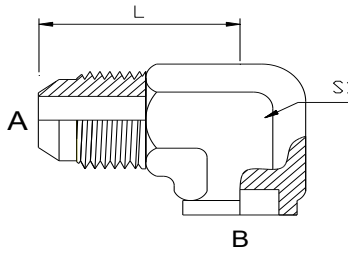

Item No	A-JIC	B-Tube	L	S1
4JW9-0704	-07 7/16-20	-04 1/4	23	12.7
4JW9-0906	-09 9/16-18	-06 3/8	27	15.9
4JW9-1206	-12 3/4-16	-06 3/8	32	20.6
4JW9-1208	-12 3/4-16	-08 1/2	32	20.6
4JW9-1410	-14 7/8-14	-10 5/8	37	23.8
4JW9-1712	-17 1.1/16-12	-12 3/4	42	28.6
4JW9-1716	-17 1.1/16-12	-16 1	48	33.0
4JW9-2116	-21 1.5/16-12	-16 1	46	34.9
4JW9-2620	-26 1.5/8-12	-20 1.1.4	52	44.5

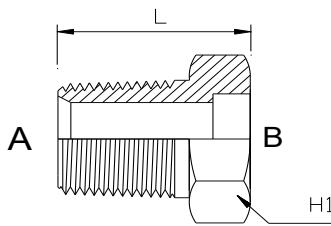
4TW
BSPT Male Tube Weld

Item No	A-BSPT	B-Tube	L	H1
4TW-0404	-04 1/4-19	-04 1/4	21	14
4TW-0406	-04 1/4-19	-06 3/8	21	14
4TW-0408	-04 1/4-19	-08 1/2	24	17
4TW-0604	-06 3/8-19	-04 1/4	25	19
4TW-0606	-06 3/8-19	-06 3/8	25	19
4TW-0608	-06 3/8-19	-08 1/2	25	19
4TW-0808	-08 1/2-14	-08 1/2	31	22
4TW-0810	-08 1/2-14	-10 5/8	31	22
4TW-0812	-08 1/2-14	-12 3/4	31	24
4TW-1212	-12 3/4-14	-12 3/4	31	30
4TW-1216	-12 3/4-14	-16 1	37	30
4TW-1616	-16 1-11	-16 1	35	36
4TW-1620	-16 1-11	-20 1.1/4	36	38
4TW-2020	-20 1.1/4-11	-20 1.1/4	38	46
4TW-2424	-24 1.1/2-11	-24 1.1/2	42	50
4TW-3232	-32 2-11	-32 2	50	65

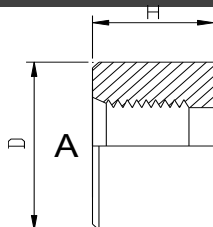
7OW
UNO Half Socket Weld On

Item No	A-UNO	H	D
7OW-12	-12 3/4-16	20	32
7OW-14	-14 7/8-14	23	36
7OW-17	-17 1.1/16-12	26	41

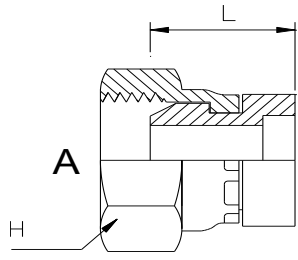
9BW
BSPP Female Tube Weld

Item No	A-BSPP	B-Tube	L	H
9BW-0404	-04 1/4-19	-04 1/4	20	19
9BW-0406	-04 1/4-19	-06 3/8	20	19
9BW-0606	-06 3/8-19	-06 3/8	22	22
9BW-0608	-06 3/8-19	-08 1/2	22	22
9BW-0808	-08 1/2-14	-08 1/2	24	27
9BW-1212	-12 3/4-14	-12 3/4	27	32
9BW-1616	-16 1-11	-16 1	30	38 *
9BW-2020	-20 1.1/4-11	-20 1.1/4		50 *
9BW-2424	-24 1.1/2-11	-24 1.1/2		55 *
9BW-3232	-32 2-11	-32 2		70 *

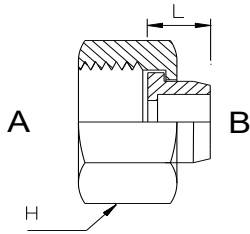
9FW
ORFS Female Tube Weld (Set)

Item No	A-ORFS	B-Tube	Weld-On only	H
9FW-0904	-09 9/16-18	-04 1/4	9FW-0904S	17.5
9FW-1106	-11 11/16-18	-06 3/8	9FW-1106S	20.6
9FW-1308	-13 13/16-16	-08 1/2	9FW-1308S	23.8
9FW-1610	-16 1-14	-10 5/8	9FW-1610S	28.6
9FW-1912	-19 1.3/16-12	-12 3/4	9FW-1912S	34.9
9FW-2316	-23 1.7/16-12	-16 1	9FW-2316S	41.3
Weld-on Only 9FW-2720	-27 1.11/16-12	-20 1.1/4	9FW-2720S	47.6

Note - the Weld-On is available separately. Order with suffix "S" eg. 9FW-0904S

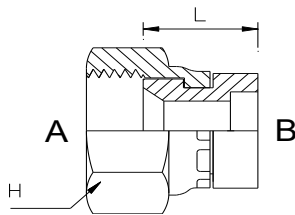
9JW
JIC Female Tube Weld

Item No	A-JIC	B-Tube	H
9JW-0704	-07 7/16-20	-04 1/4	14.3
9JW-0706	-07 7/16-20	-06 3/8	14.3
9JW-0904	-09 9/16-18	-04 1/4	17.5
9JW-0906	-09 9/16-18	-06 3/8	17.5
9JW-1206	-12 3/4-16	-06 3/8	22.2
9JW-1208	-12 3/4-16	-08 1/2	22.2
9JW-1210	-12 3/4-16	-10 5/8	22.2
9JW-1408	-14 7/8-14	-08 1/2	25.4
9JW-1410	-14 7/8-14	-10 5/8	25.4
9JW-1412	-14 7/8-14	-12 3/4	25.4
9JW-1712	-17 1.1/16-12	-12 3/4	32.0
9JW-1716	-17 1.1/16-12	-16 1	32.0
9JW-2116	-21 1.5/16-12	-16 1	41 *
9JW-2120	-21 1.5/16-12	-20 1.1/4	41 *
9JW-2620	-26 1.5/8-12	-20 1.1/4	50 *
9JW-2624	-26 1.5/8-12	-24 1.1/2	50 *
9JW-3024	-30 1.7/8-12	-24 1.1/2	55 *
9JW-4032	-40 2.1/2-12	-32 2	70 *

1FG4

ORFS Male x BSPP Male 45 Elbow

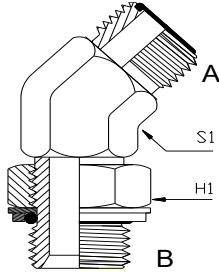

Item No	A-ORFS	B-BSPP	S1	H
1FG4-0904	-09 9/16-18	-04 1/4-19	14	19
1FG4-1104	-11 11/16-16	-04 1/4-19	19	19
1FG4-1106	-11 11/16-16	-06 3/8-19	19	22
1FG4-1306	-13 13/16-16	-06 3/8-19	22	22
1FG4-1308	-13 13/16-16	-08 1/2-14	22	27
1FG4-1608	-16 1-14	-08 1/2-14	27	27
1FG4-1612	-16 1-14	-12 3/4-14	27	32
1FG4-1908	-19 1.3/16-12	-08 1/2-14	30	27
1FG4-1912	-19 1.3/16-12	-12 3/4-14	30	32
1FG4-2316	-23 1.7/16-12	-16 1-11	36	41

1FN4

ORFS Male x NPT Male 45 Elbow

SAE Specification

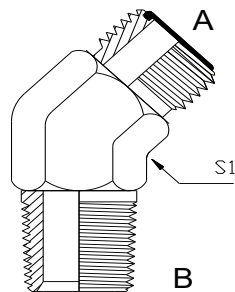

Item No	A-ORFS	B-NPT	S1
1FN4-0904	-09 9/16-18	-04 1/4-18	14.3
1FN4-1106	-11 11/16-16	-06 3/8-18	19.1
1FN4-1308	-13 13/16-16	-08 1/2-14	22.2
1FN4-1608	-16 1-14	-08 1/2-14	27.0
1FN4-1912	-19 1.3/16-12	-12 3/4-14	31.2
1FN4-2316	-23 1.7/16-12	-16 1-11.5	36.5

1FO4

ORFS Male x UNO Male 45 Elbow

SAE Specification

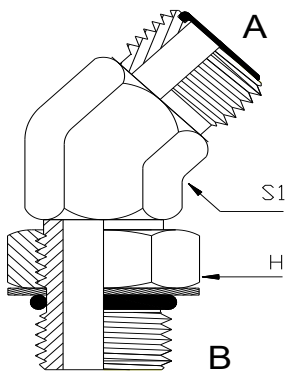

Item No	A-ORFS	B-UNO	S1	H
1FO4-0907	-09 9/16-18	-07 7/16-20	14.3	15.9
1FO4-0909	-09 9/16-18	-09 9/16-18	19.1	19.1
1FO4-1107	-11 11/16-16	-07 7/16-20	19.1	15.9
1FO4-1109	-11 11/16-16	-09 9/16-18	19.1	19.1
1FO4-1112	-11 11/16-16	-12 3/4-16	19.1	23.8
1FO4-1114	-11 11/16-16	-14 7/8-14	27.0	27.0
1FO4-1309	-13 13/13-16	-09 9/16-19	19.1	19.1
1FO4-1312	-13 13/16-16	-12 3/4-16	19.1	23.8
1FO4-1314	-13 13/16-16	-14 7/8-14	27.0	27.0
1FO4-1612	-16 1-14	-12 3/4-16	27.0	34.9
1FO4-1614	-16 1-14	-14 7/8-14	27.0	27.0
1FO4-1914	-19 1.3/16-12	-14 7/8-14	31.2	27.0
1FO4-1917	-19 1.3/16-12	-17 1.1/16-12	31.2	34.9
1FO4-1921	-19 1.3/16-12	-21 1.5/16-12	36.5	41.3
1FO4-2321	-23 1.7/16-12	-21 1.5/16-12	36.5	41.3
1FO4-2726	-26 1.5/8-12	-26 1.5/8-12	41.3	47.6
1FO4-2730	-27 1.11/16-12	-30 1.7/8-12	47.6	54.0

1J4
JIC Male x JIC Male 45 Elbow

SAE Specification

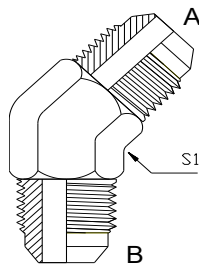

Item No	A-JIC	B-JIC	S1
1J4-0707	-07 7/16-20	-07 7/16-20	11.1
1J4-0808	-08 1/2-20	-08 1/2-20	14.3
1J4-0909	-09 9/16-18	-09 9/16-18	14.3
1J4-1212	-12 3/4-16	-12 3/4-16	19.1
1J4-1414	-14 7/8-14	-14 7/8-14	22.2
1J4-1717	-17 1.1/16-12	-12 1.1/16-12	27.0
1J4-2121	-21 1.5/16-12	-21 1.5/16-12	33.3
1J4-2626	-26 1.5/8-12	-26 1.5/8-12	41.3
1J4-3030	-30 1.7/8-12	-30 1.7/8-12	47.6

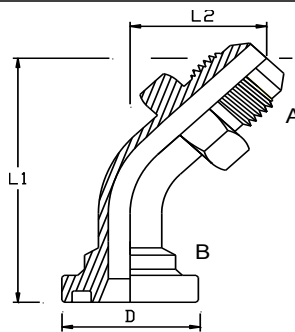
1JFL4
JIC Male x SAE Cd 61 Flange 45 Swept Bend

Item No	A-JIC	B-CD61	L1	L2	D
1JFL4-1208	-12 3/4-16	-08 1/2	64	31	30.2
1JFL4-1412	-14 7/8-14	-12 3/4	73	38	38.1
1JFL4-1712	-17 1.1/16-12	-12 3/4	73	38	38.1
1JFL4-1716	-17 1.1/16-12	-16 1	73	38	44.4
1JFL4-2112	-21 1.5/16-12	-12 3/4	86	43	38.1
1JFL4-2116	-21 1.5/16-12	-16 1	88	44	44.4
1JFL4-2120	-21 1.5/16-12	-20 1.1/4	86	44	50.8
1JFL4-2620	-26 1.5/8-12	-20 1.1/4	94	50	50.8
1JFL4-2624	-26 1.5/8-12	-24 1.1/2	96	50	60.3
1JFL4-3024	-30 1.7/8-12	-24 1.1/2	112	56	60.3
1JFL4-4032	-40 2.1/2-12	-32 2	149	85	71.4

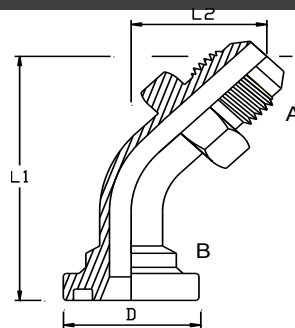
1JFLH4
JIC Male x SAE Cd 62 Flange 45 Swept Bend

Item No	A-JIC	B-CD62	L1	L2	D
1JFLH4-1712	-17 1.1/16-12	-12 3/4	77	38	41.3
1JFLH4-1716	-17 1.1/16-12	-16 1	80	38	47.6
1JFLH4-2116	-21 1.5/16-12	-16 1	91	44	47.6
1JFLH4-2120	-21 1.5/16-12	-20 1.1/4	95	44	54.0
1JFLH4-2620	-26 1.5/8-12	-20 1.1/4	107	50	54.0
1JFLH4-3024	-30 1.7/8-12	-24 1.1/2	125	56	63.5

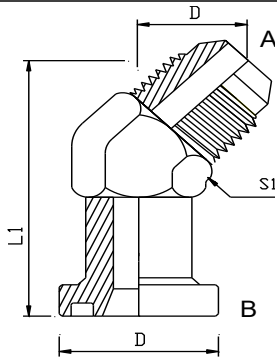
1JFL4C
JIC Male x SAE Cd 61 Flange 45 Elbow

Item No	A-JIC	B-CD61	L1	L2	D
1JFL4C-1712	-17 1.1/16-12	-12 3/4	53	23	38.1
1JFL4C-1716	-17 1.1/16-12	-16 1	73	26	44.5
1JFL4C-2116	-21 1.5/16-12	-16 1	73	26	44.5

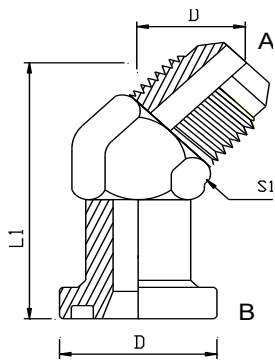
1JFLH4C
JIC Male x SAE Cd 62 Flange 45 Elbow

Item No	A-JIC	B-CD62	L1	L2	D
1JFLH4C-1208	-17 1.1/16-12	-12 3/4	62	23	
1JFLH4C-1712	-17 1.1/16-12	-12 3/4	63	23	38.1
1JFLH4C-1716	-17 1.1/16-12	-16 1	73	26	44.5
1JFLH4C-2116	-21 1.5/16-12	-16 1	73	26	44.5
1JFLH4C-2620	-26 1.5/8-12	-20 1.1/4	80	29	
1JFLH4C-3024	-30 1.7/8-12	-24 1.1/2	92	32	

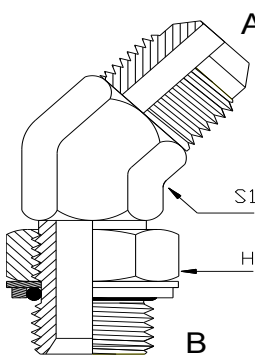
1JG4
JIC Male x JIC Male 45 Elbow

Item No	A-JIC	B-JIC	S1	H
1JG4-0702	-07 7/16-20	-02 1/8-28	11	14
1JG4-0704	-07 7/16-20	-04 1/4-19	14	19
1JG4-0706	-07 7/16-20	-06 3/8-19	19	22
1JG4-0904	-09 9/16-18	-04 1/4-19	14	19
1JG4-0906	-09 9/16-18	-06 3/8-19	19	22
1JG4-0908	-09 9/16-18	-08 1/2-14	22	27
1JG4-1204	-12 3/4-16	-04 1/4-19	19	19
1JG4-1206	-12 3/4-16	-06 3/8-19	19	22
1JG4-1208	-12 3/4-16	-08 1/2-14	22	27
1JG4-1212	-12 3/4-16	-12 3/4-12	27	32
1JG4-1406	-14 7/8-14	-06 3/8-19	22	22
1JG4-1408	-14 7/8-14	-08 1/2-14	22	27
1JG4-1412	-14 7/8-14	-12 3/4-14	27	32
1JG4-1708	-17 1.1/16-12	-08 1/2-14	27	22
1JG4-1712	-17 1.1/16-12	-12 3/4-14	27	32
1JG4-1716	-17 1.1/16-12	-16 1-11	33	41
1JG4-2116	-21 1.5/16-12	-16 1-11	33	41
1JG4-2620	-26 1.5/8-12	-20 1.1/4-11	41	50
1JG4-3024	-30 1.7/8-12	-24 1.1/2-11	41	55

1JN4
JIC Male x NPT Male 45 Elbow

SAE Specification

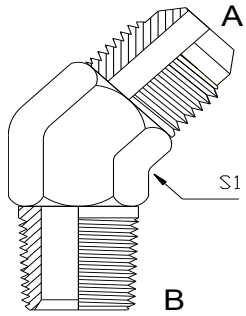

Item No	A-JIC	B-NPT	S1
1JN4-0502	-05 5/16-24	-02 1/8-27	11.1
1JN4-0602	-06 3/8-24	-02 1/8-27	11.1
1JN4-0702	-07 7/16-20	-02 1/8-27	11.1
1JN4-0704	-07 7/16-20	-04 1/4-18	14.3
1JN4-0706	-07 7/16-20	-06 3/8-18	19.1
1JN4-0708	-07 7/16-20	-08 1/2-14	22.2
1JN4-0802	-08 1/2-20	-02 1/8-27	14.3
1JN4-0804	-08 1/2-20	-04 1/4-18	14.3
1JN4-0806	-08 1/2-20	-06 3/8-18	19.1
1JN4-0902	-09 9/16-18	-02 1/8-27	14.3
1JN4-0904	-09 9/16-18	-04 1/4-18	14.3
1JN4-0906	-09 9/16-18	-06 3/8-18	19.1
1JN4-0908	-09 9/16-18	-08 1/2-14	22.2
1JN4-0912	-09 9/16-18	-12 3/4-14	27.0
1JN4-1204	-12 3/4-16	-04 1/4-18	19.1
1JN4-1206	-12 3/4-16	-06 3/8-18	19.1
1JN4-1208	-12 3/4-16	-08 1/2-14	22.2
1JN4-1212	-12 3/4-16	-08 1/2-14	22.2
1JN4-1406	-14 7/8-14	-06 3/8-18	22.2
1JN4-1408	-14 7/8-14	-08 1/2-14	22.2
1JN4-1412	-14 7/8-14	-12 3/4-14	27.0
1JN4-1708	-17 1.1/16-12	-08 1/2-14	27.0
1JN4-1712	-17 1.1/16-12	-12 3/4-14	27.0
1JN4-1716	-17 1.1/16-12	-16 1-11.5	33.3
1JN4-2112	-21 1.5/16-12	-12 3/4-14	33.3
1JN4-2116	-21 1.5/16-12	-16 1-11.5	33.3
1JN4-2120	-21 1.5/16-12	-20 1.1/4-11.5	41.3
1JN4-2616	-26 1.5/8-12	-16 1-11.5	41.3
1JN4-2620	-26 1.5/8-12	-20 1.1/4-11.5	41.3
1JN4-2624	-26 1.5/8-12	-24 1.1/2-11.5	47.6
1JN4-3024	-30 1.7/8-12	-24 1.1/2-11.5	47.6
1JN4-4032	-40 2.1/2-12	-32 2-11.5	63.5

1JO4
JIC Male x UNO Male 45 Elbow

SAE Specification

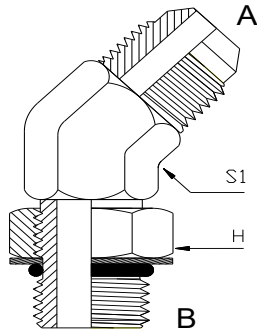

Item No	A-JIC	B-UNO	S1	H
1JO4-0707	-07 7/16-20	-07 7/16-20	11.1	14.3
1JO4-0709	-07 7/16-20	-09 9/16-18	14.3	17.5
1JO4-0907	-09 9/16-18	-07 7/16-20	14.3	14.3
1JO4-0909	-09 9/16-18	-09 9/16-18	14.3	17.5
1JO4-0912	-09 9/16-18	-12 3/4-16	19.1	22.2
1JO4-0914	-09 9/16-18	-14 7/8-14	22.2	25.4
1JO4-1209	-12 3/4-16	-09 9/16-18	19.1	17.5
1JO4-1212	-12 3/4-16	-12 3/4-16	19.1	22.2
1JO4-1214	-12 3/4-16	-14 7/8-14	22.2	25.4
1JO4-1217	-12 3/4-16	-17 1.1/16-12	27.0	31.8
1JO4-1412	-14 7/8-14	-12 3/4-16	22.2	22.2
1JO4-1414	-14 7/8-14	-14 7/8-14	22.2	25.4
1JO4-1417	-14 7/8-14	-17 1.1/16-12	27.0	31.8
1JO4-1712	-17 1.1/16-12	-12 3/4-16	27.0	22.2
1JO4-1714	-17 1.1/16-12	-14 7/8-14	27.0	25.4
1JO4-1717	-17 1.1/16-12	-17 1.1/16-12	27.0	31.8
1JO4-1721	-17 1.1/16-12	-21 1.5/16-12	33.3	38.1
1JO4-2117	-21 1.5/16-12	-17 1.1/16-12	33.3	31.8
1JO4-2121	-21 1.5/16-12	-21 1.5/16-12	33.3	38.1
1JO4-2626	-26 1.5/8-12	-26 1.5/8-12	41.3	47.6
1JO4-3030	-30 1.7/8-12	-30 1.7/8-12	47.6	54.0

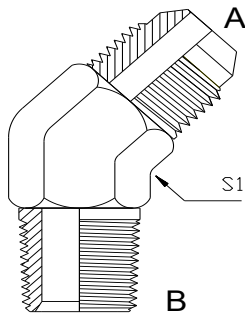
1JT4
JIC Male x BSPT Male 45 Elbow

Item No	A-JIC	B-BSPT	S1
1JT4-0702	-07 7/16-20	-02 1/8-28	11
1JT4-0704	-07 7/16-20	-04 1/4-19	14
1JT4-0706	-07 7/16-20	-06 3/8-19	19
1JT4-0802	-08 1/2-20	-02 1/8-28	14
1JT4-0804	-08 1/2-20	-04 1/4-19	14
1JT4-0902	-09 9/16-18	-02 1/8-28	14
1JT4-0904	-09 9/16-18	-04 1/4-19	14
1JT4-0906	-09 9/16-18	-06 3/8-19	19
1JT4-0908	-09 9/16-18	-08 1/2-14	22
1JT4-1204	-12 3/4-16	-04 1/4-19	19
1JT4-1206	-12 3/4-16	-06 3/8-19	19
1JT4-1208	-12 3/4-16	-08 1/2-14	22
1JT4-1212	-12 3/4-16	-12 3/4-14	27
1JT4-1406	-14 7/8-14	-06 3/8-19	22
1JT4-1408	-14 7/8-14	-08 1/2-14	22
1JT4-1412	-14 7/8-14	-12 3/4-14	27
1JT4-1708	-17 1.1/16-12	-08 1/2-14	27
1JT4-1712	-17 1.1/16-12	-12 3/4-14	27
1JT4-1716	-17 1.1/16-12	-16 1-11	33
1JT4-2112	-21 1.5/16-12	-12 3/4-14	33
1JT4-2116	-21 1.5/16-12	-16 1-11	33
1JT4-2620	-26 1.5/8-12	-20 1.1/4-11	41
1JT4-3024	-30 1.7/8-12	-24 1.1/2-11	48
1JT4-4032	-40 2.1/2-12	-32 2-11	65

1N4
NPT Male x NPT Male 45 Elbow

SAE Specification

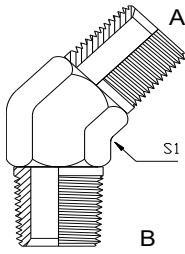

Item No	A-NPT	B-NPT	S1
1N4-0202	-02 1/8-27	-02 1/8-27	11.1
1N4-0404	-04 1/4-18	-04 1/4-18	14.3
1N4-0606	-06 3/8-18	-06 3/8-18	19.1
1N4-0808	-08 1/2-14	-08 1/2-14	22.2
1N4-1208	-12 3/4-14	-08 1/2-14	27.0
1N4-1212	-12 3/4-14	-12 3/4-14	27.0
1N4-1616	-16 1-11.5	-16 1-11.5	33.3
1N4-2020	-20 1.1/4-11.5	-20 1.1/4-11.5	41.3

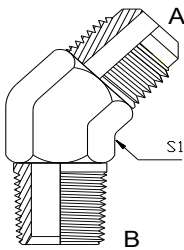
1PT4
SAE Male x BSPT Male 45 Elbow

Item No	A-SAE	B-BSPT	S1
1PT4-1004	-10 5/8-18	-04 1/4-19	19
1PT4-1006	-10 5/8-18	-06 3/8-19	19

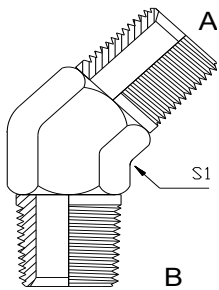
1T4
BSPT Male x BSPT Male 45 Elbow

Item No	A-BSPT	B-BSPT	S1
1T4-0202	-02 1/8-28	-02 1/8-28	11
1T4-0402	-04 1/4-19	-02 1/8-28	14
1T4-0404	-04 1/4-19	-04 1/4-19	14
1T4-0604	-06 3/8-19	-04 1/4-19	19
1T4-0606	-06 3/8-19	-06 3/8-19	19
1T4-0806	-08 1/2-14	-06 3/8-19	22
1T4-0808	-08 1/2-14	-08 1/2-14	22
1T4-1208	-12 3/4-14	-08 1/2-14	27
1T4-1212	-12 3/4-14	-12 3/4-14	27
1T4-1612	-16 1-11	-12 3/4-14	33
1T4-1616	-16 1-11	-16 1-11	33
1T4-2020	-20 1.1/4-11	-20 1.1/4-11	41

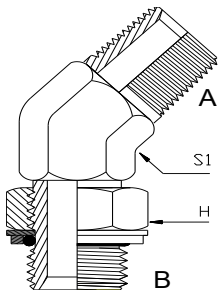
1TG4
BSPT Male x BSPP Male 45 Elbow

Item No	A-BSPT	B-BSPP	S1	H
1TG4-0404	-04 1/4-19	-04 1/4-19	14	19
1TG4-0606	-06 3/8-19	-06 3/8-19	19	22
1TG4-0808	-08 1/2-14	-08 1/2-14	22	27
1TG4-1212	-12 3/4-14	-12 3/4-14	27	32
1TG4-1616	-16 1-11	-16 1-11	33	41

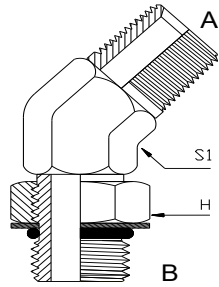
1T04
BSPT Male x UNO Male 45 Elbow

Item No	A-BSPT	B-UNO	S1	H
1T04-0409	-04 1/4-19	-09 9/16-18	14	17.5
1T04-0609	-06 3/8-19	-09 9/16-18	19	17.5
1T04-0612	-06 3/8-19	-12 3/4-16	19	22.2
1T04-0812	-08 1/2-14	-12 3/4-16	22	22.2
1T04-0814	-08 1/2-14	-14 7/8-14	22	25.4
1T04-1217	-12 3/4-14	-17 1.1/16-12	27	31.8
1T04-1621	-16 1-11	-21 1.5/16-12	33	38.1

2F4
ORFS Male x ORFS Female 45 Elbow

SAE Specification

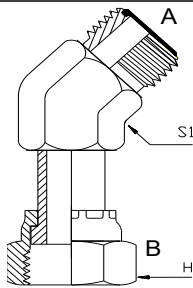

Item No	A-ORFS	B-ORFS	S1	H
2F4-0909	-09 9/16-18	-09 9/16-18	14.3	17.5
2F4-1111	-11 11/16	-11 11/16-16	19.1	20.6
2F4-1313	-13 13/16-16	-13 13/16-16	19.1	23.8
2F4-1616	-16 1-14	-16 1-14	27.0	28.6
2F4-1919	-19 1.3/16-12	-19 1.3/16-16	34.9	34.9
2F4-2323	-23 1.7/16-12	-23 1.7/16-12	36.5	41.3
2F4-2727	-27 1.11/16-12	-27 1.11/16-12	41.3	47.6
2F4-3232	-32 2-12	-32 2-12	47.6	57.2

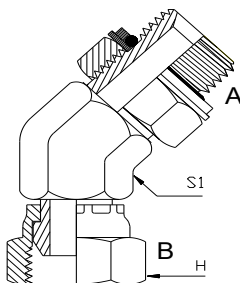
2GB4
BSPF Male x BSP Female Elbow

Item No	A-BSPF	B-BSP	S1	H
2GB4-0808	-08 1/2-14	-08 1/2-14	22	27
2GB4-1212	-12 3/4-14	-12 3/4-14	27	32
2GB4-1616	-16 1-11	-16 1-11	33	41 *

2J4
JIC Male x JIC Female 45 Elbow

SAE Specification

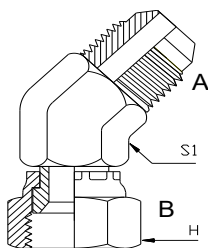

Item No	A-JIC	B-JIC	S1	H
2J4-0707	-07 7/16-20	-07 7/16-20	11.1	14.3
2J4-0808	-08 1/2-20	-08 1/2-20	14.3	15.9
2J4-0909	-09 9/16-18	-09 9/16-18	14.3	17.5
2J4-1212	-12 3/4-16	-12 3/4-16	17.5	22.2
2J4-1414	-14 7/8-14	-14 7/8-14	22.2	25.4
2J4-1717	-17 1.1/16-12	-17 1.1/16-12	27.0	31.8
2J4-1919	-19 1.3/16-12	-19 1.3/16-12	33.3	34.9
2J4-2121	-21 1.5/16-12	-21 1.5/16-12	33.3	38.0
2J4-2626	-26 1.5/8-12	-26 1.5/8-12	41.3	50.0
2J4-3030	-30 1.7/8-12	-30 1.7/8-12	47.6	55.0
2J4-4040	-40 2.1/2-12	-40 2.1/2-12	63.5	73.0

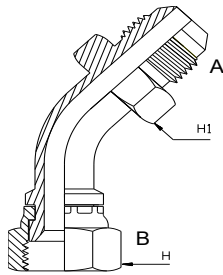
2J4-T
JIC Male x JIC Female 45 Swept Bend

Item No	A-JIC	B-JIC	H1	H
2J4-T-0707	-07 7/16-20	-07 7/16-20	12	14.3
2J4-T-0909	-09 9/16-18	-09 9/16-18	17	17.5
2J4-T-1212	-12 3/4-16	-12 3/4-16	22	22.2
2J4-T-1414	-14 7/8-14	-14 7/8-14	24	25.4
2J4-T-1717	-17 1.1/16-12	-17 1.1/16-12	30	31.8
2J4-T-2121	-21 1.5/16-12	-21 1.5/16-12	36	41 *
2J4-T-2626	-26 1.5/8-12	-26 1.5/8-12	42	50 *

2NU4
NPT Male x NPSM Female 45 Elbow

SAE Specification

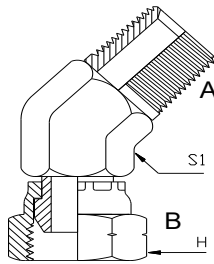

Item No	A-NPT	B-NPSM	S1	H
2NU4-0202	-02 1/8-27	-02 1/8-27	11.1	14.3
2NU4-0404	-04 1/4-18	-04 1/4-18	14.3	17.5
2NU4-0606	-06 3/8-18	-06 3/8-18	19.1	22.2
2NU4-0808	-08 1/2-14	-08 1/2-14	22.2	25.4
2NU4-1212	-12 3/4-14	-12 3/4-14	27.0	31.8
2NU4-1616	-16 1-11.5	-16 1-11.5	33.3	38.1

2OJ4
UNO Male x JIC Female 45 Elbow

SAE Specification

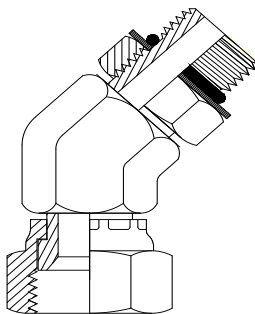

Item No	A-UNO	B-JIC	S1	H
2OJ4-0707	-07 7/16-20	-07 7/16-20	14.3	14.3
2OJ4-0909	-09 9/16-18	-09 9/16-18	17.5	17.5
2OJ4-1212	-12 3/4-16	-12 3/4-16	19.1	22.2
2OJ4-1717	-17 1.1/16-12	-17 1.1/16-12	27.0	31.8
2OJ4-2121	-21 1.5/16-12	-21 1.5/16-12	33.3	38.1

2OU4
UNO Male x NPSM Female 45 Elbow

SAE Specification

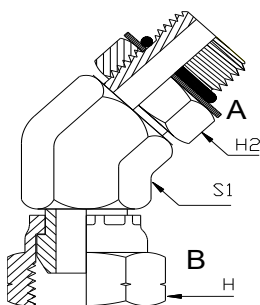

Item No	A-UNO	B-NPSM	S1	H
2OU4-0704	-07 7/16-20	-04 1/4-18	14.3	17.5
2OU4-0906	-09 9/16-18	-06 3/8-18	19.1	22.2
2OU4-1208	-12 3/4-16	-08 1/2-14	22.2	25.4
2OU4-1408	-14 7/8-14	-08 1/2-14	22.2	25.4
2OU4-1712	-17 1.1/16-12	-12 3/4-14	27.0	31.8
2OU4-2116	-21 1.5/16-12	-16 1-11.5	33.3	38.1

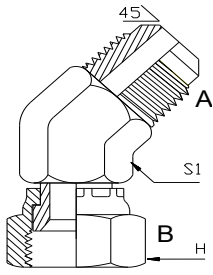
2P4
SAE Male xSAE Female 45 Elbow

Item No	A-SAE	B-SAE	S1	H
2P4-1010	-10 5/8-18	-10 5/8-18	19	22
2P4-1717	-17 1.1.16-14	-17 1.1.16-14	27	31.8

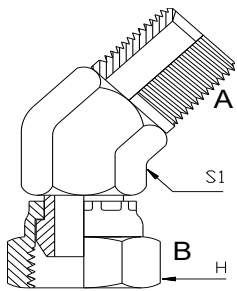
2TB4
BSPT Male x BSPP Female 45 Elbow

Item No	A-BSPT	B-BSPP	S1	H
2TB4-0202	-02 1/8-28	-02 1/8-28	11	14
2TB4-0404	-04 1/4-19	-04 1/4-19	14	19
2TB4-0406	-04 1/4-19	-06 3/8-19	19	22
2TB4-0606	-06 3/8-19	-06 3/8-19	19	22
2TB4-0808	-08 1/2-14	-08 1/2-14	22	27
2TB4-1212	-12 3/4-14	-12 3/4-14	27	32
2TB4-1616	-16 1-11	-16 1-11	33	41 *
2TB4-1620	-16 1-11	-20 1.1/4-11	41	50 *
2TB4-2020	-20 1.1/4-11	-20 1.1/4-11	41	50 *
2TB4-2424	-24 1.1/2-11	-24 1.1/2-11	48	55 *
2TB4-3232	-32 2-11	-32 2-11	63	73 *

5N4
NPT Male x NPT Female 45 Elbow

SAE Specification

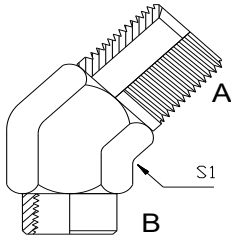

Item No	A-NPT	B-NPT	S1
5N4-0202	-02 1/8-27	-02 1/8-27	14.3
5N4-0404	-04 1/4-18	-04 1/4-18	19.1
5N4-0606	-06 3/8-18	-06 3/8-18	22.2
5N4-0808	-08 1/2-14	-08 1/2-14	27.0
5N4-1212	-12 3/4-14	-12 3/4-14	33.3
5N4-1616	-16 1-11.5	-16 1-11.5	41.3
5N4-2020	-20 1.1/4-11.5	-20 1.1/4-11.5	47.6
5N4-2424	-24 1.1/2-11.5	-24 1.1/2-11.5	65.1

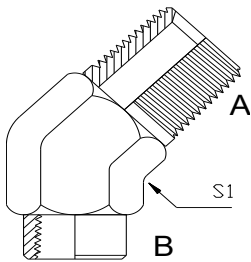
5T4
BSPT Male x BSPT Female 45 Elbow

Item No	A-BSPT	B-BSPT	S1
5T4-0202	-02 1/8-28	-02 1/8-28	14
5T4-0402	-04 1/4-19	-02 1/8-28	14
5T4-0404	-04 1/4-19	-04 1/4-19	19
5T4-0606	-06 3/8-19	-06 3/8-19	24
5T4-0808	-08 1/2-14	-08 1/2-14	27
5T4-1212	-12 3/4-14	-12 3/4-14	33
5T4-1616	-16 1-11	-16 1-11	41

6F4
ORFS Male x ORFS Male 45 Bulkhead

SAE Specification

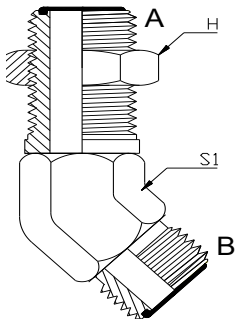

Item No	A-ORFS	B-ORFS	S1	H
6F4-0909	-09 9/16-18	-09 9/16-18	14.3	20.6
6F4-1111	-11 11/16-16	-11 11/16-16	19.1	25.4
6F4-1313	-13 13/16-16	-13 13/16-16	19.1	31.8
6F4-1616	-16 1-14	-16 1-14	27.0	33.3
6F4-1919	-19 1.3/16-12	-19 1.3/16-12	31.2	38.1
6F4-2323	-23 1.7/16-12	-23 1.7/16-12	36.5	44.5
6F4-2727	-27 1.11/16-16	-27 1.11/16-16	41.3	50.8

6J4
JIC Male x JIC Male 45 Bulkhead

SAE Specification

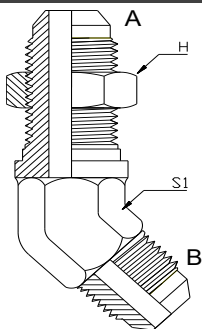

Item No	A-JIC	B-JIC	S1	H
6J4-0707	-07 7/16-20	-07 7/16-20	11.1	17.5
6J4-0808	-08 1/2-20	-08 1/2-20	14.3	19.1
6J4-0909	-09 9/16-18	-09 9/16-18	14.3	20.6
6J4-1212	-12 3/4-16	-12 3/4-16	17.5	25.4
6J4-1414	-14 7/8-14	-14 7/8-14	22.2	28.6
6J4-1717	-17 1.1/16-12	-17 1.1/16-12	27.0	34.9
6J4-2121	-21 1.5/16-12	-21 1.5/16-12	33.3	41.3

7N4
NPT Male x NPT Female 45 Elbow

SAE Specification

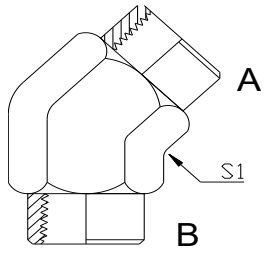

Item No	A-NPT	B-NPT	S1
7N4-0202	-02 1/8-27	-02 1/8-27	14.3
7N4-0404	-04 1/4-18	-04 1/4-18	19.1
7N4-0606	-06 3/8-18	-06 3/8-18	22.2
7N4-0808	-08 1/2-14	-08 1/2-14	27.0
7N4-1212	-12 3/4-14	-12 3/4-14	33.3
7N4-1616	-16 1-11.5	-16 1-11.5	41.3

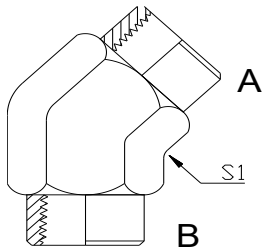
7T4
BSPT Female x BSPT Female 45 Elbow

Item No	A-BSPT	B-BSPT	S1
7T4-0202	-02 1/8-28	-02 1/8-28	14
7T4-0404	-04 1/4-19	-04 1/4-19	19
7T4-0606	-06 3/8-19	-06 3/8-19	22
7T4-0808	-08 1/2-14	-08 1/2-14	27
7T4-1212	-12 3/4-14	-12 3/4-14	33
7T4-1616	-16 1-11	-16 1-11	41

67 DEGREE

1JG6

JIC Male x BSPP Male 67 Degree Elbow

Item No	A-JIC	B-BSPP	S1	H
1JG6-1712	-17 1.1/16-12	-12 3/4-11	27	36

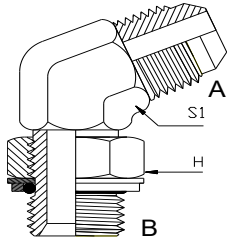

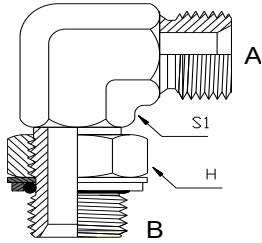
90 DEGREE
1BG9
BSPP Male x BSPP Male 90 Elbow

Item No	A-BSPP	B-BSPP	S1	H
1BG9-0404	-04 1/4-19	-04 1/4-19	14	19
1BG9-0604	-06 3/8-19	-04 1/4-19	19	22
1BG9-0606	-06 3/8-19	-06 3/8-19	19	22
1BG9-0806	-08 1/2-14	-06 3/8-19	22	22
1BG9-0808	-08 1/2-14	-08 1/2-14	22	27
1BG9-1212	-12 3/4-14	-12 3/4-14	27	32
1BG9-1616	-16 1-11	-16 1-11	33	41
1BG9-2020	-20 1.1/4-11	-20 1.1/4-11	41	50

1F9
ORFS Male x ORFS Male 90 Elbow

SAE Specification

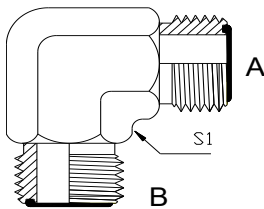

Item No	A-ORFS	B-ORFS	S1
1F9-0909	-09 9/16-18	-09 9/16-18	14.3
1F9-1111	-11 11/16	-11 11/16-16	19.1
1F9-1313	-13 13/16-16	-13 13/16-16	19.1
1F9-1616	-16 1-14	-16 1-14	27.0
1F9-1919	-19 1.3/16-12	-19 1.3/16-16	31.2
1F9-2323	-23 1.7/16-12	-23 1.7/16-12	36.5
1F9-2727	-27 1.11/16-12	-27 1.11/16-12	41.3

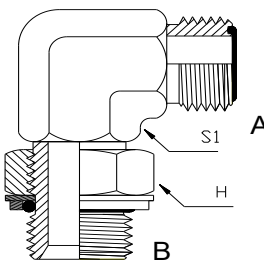
1FG9
ORFS Male x BSPP Male 90 Elbow

Item No	A-ORFS	B-BSPP	S1	H
1FG9-0902	-09 9/16-18	-02 1/8-28	14	14
1FG9-0904	-09 9/16-18	-04 1/4-19	14	19
1FG9-0906	-09 9/16-18	-06 3/8-19	19	22
1FG9-0908	-09 9/16-18	-08 1/2-14	22	27
1FG9-1104	-11 11/16-16	-04 1/4-19	19	19
1FG9-1106	-11 11/16-16	-06 3/8-19	19	22
1FG9-1108	-11 11/16-16	-08 1/2-14	22	27
1FG9-1304	-13 13/16-16	-04 1/4-19	19	19
1FG9-1306	-13 13/16-16	-06 3/8-19	19	22
1FG9-1308	-13 13/16-16	-08 1/2-14	22	27
1FG9-1312	-13 13/16-16	-12 3/4-14	27	32
1FG9-1608	-16 1-14	-08 1/2-14	27	27
1FG9-1612	-16 1-14	-12 3/4-14	27	32
1FG9-1908	-19 1.3/16-12	-08 1/2-14	30	27
1FG9-1912	-19 1.3/16-12	-12 3/4-14	30	32
1FG9-1916	-19 1.3/16-12	-16 1-12	33	41
1FG9-2316	-23 1.7/16-12	-16 1-12	36	41

1FN9
ORFS Male x NPT Male 90 Elbow

SAE Specification

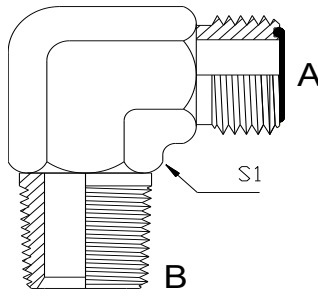

Item No	A-ORFS	B-NPT	S1
1FN9-0902	-09 9/16-18	-02 1/8-27	14.3
1FN9-0904	-09 9/16-18	-04 1/4-18	14.3
1FN9-1104	-11 11/16-16	-04 1/4-18	19.1
1FN9-1106	-11 11/16-16	-06 3/8-18	19.1
1FN9-1108	-11 11/16-16	-08 1/2-14	22.2
1FN9-1306	-13 13/16-16	-06 3/8-18	19.1
1FN9-1308	-13 13/16-16	-08 1/2-14	22.2
1FN9-1312	-13 13/16-16	-12 3/4-14	27.0
1FN9-1608	-16 1-14	-08 1/2-14	27.0
1FN9-1612	-16 1-14	-12 3/4-14	27.0
1FN9-1908	-19 1.3/16-12	-08 1/2-14	31.2
1FN9-1912	-19 1.3/16-12	-12 3/4-14	31.2
1FN9-1916	-19 1.3/16-12	-16 1-11.5	33.3
1FN9-2312	-23 1.7/16-12	-12 3/4-14	36.5
1FN9-2316	-23 1.7/16-12	-16 1-11.5	36.5
1FN9-2320	-23 1.7/16-12	-20 1.1/4-11.5	41.3
1FN9-2720	-27 1.11/16-12	-20 1.1/4-11.5	41.3
1FN9-3224	-32 2-12	-24 1.1/2-11.5	47.6

1FO9
ORFS Male x UNO Male 90 Elbow

SAE Specification

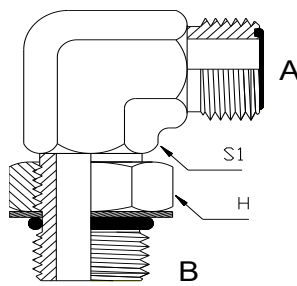

Item No	A-ORFS	B-UNO	S1	H
1FO9-0907	-09 9/16-18	-07 7/16-20	14.3	15.9
1FO9-0909	-09 9/16-18	-09 9/16-18	14.3	19.1
1FO9-1107	-11 11/16-16	-07 7/16-20	19.1	15.9
1FO9-1108	-11 11/16-16	-08 1/2-20	19.1	17.5
1FO9-1109	-11 11/16-16	-09 9/16-18	19.1	19.1
1FO9-1112	-11 11/16-16	-12 3/4-16	19.1	22.2
1FO9-1114	-11 11/16-16	-14 7/8-14	27.0	27.0
1FO9-1117	-11 11/16-16	-17 1.1/16-12	30.2	34.9
1FO9-1309	-13 13/16-16	-09 9/16-18	19.1	19.1
1FO9-1312	-13 13/16-16	-12 3/4-16	19.1	22.2
1FO9-1314	-13 13/16-16	-14 7/8-14	27.0	27.0
1FO9-1317	-13 13/16-16	-17 1.1/16-12	30.2	34.9
1FO9-1612	-16 1-14	-12 3/4-16	27.0	22.2
1FO9-1614	-16 1-14	-14 7/8-14	27.0	27.0
1FO9-1617	-16 1-14	-17 1.1/16-12	27.0	34.9
1FO9-1912	-19 1.3/16-12	-12 3/4-16	30.2	22.2
1FO9-1914	-19 1.3/16-12	-14 7/8-14	30.2	27.0
1FO9-1917	-19 1.3/16-12	-17 1.1/16-12	30.2	34.9
1FO9-1921	-19 1.3/16-12	-21 1.5/16-12	36.5	41.3
1FO9-2317	-23 1.7/16-12	-17 1.1/16-12	36.5	34.9
1FO9-2321	-23 1.7/16-12	-21 1.5/16-12	36.5	41.3
1FO9-2326	-23 1.7/16-12	-26 1.5/8-12	41.3	41.3
1FO9-2721	-27 1.11/16-12	-21 1.5/16-12	36.5	41.3
1FO9-2726	-27 1.11/16-12	-26 1.5/8-12	41.3	47.6
1FO9-2730	-27 1.11/16-12	-30 1.7/8-12	47.2	54.0
1FO9-3226	-32 2-12	-26 1.5/8-12	41.3	47.6
1FO9-3230	-32 2-12	-30 1.7/8-12	47.2	47.6

1GG9

BSPP Male x BSPP Male 90 Elbow

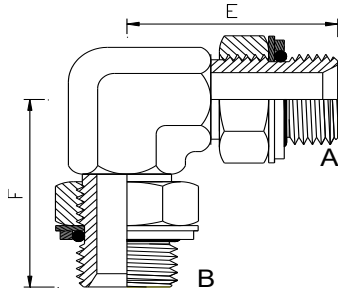

Item No	A-BSPP	B-BSPP	E	F
1GG9-0808	-08 1/2-14	-08 1/2-14	43	43
1GG9-1212	-12 3/4-14	-12 3/4-14	49	49
1GG9-1612	-16 1-11	-12 3/4-14	53	50
1GG9-1616	-16 1-11	-16 1-11	53	53

1GO9

BSPP Male x UNO Male 90 Elbow

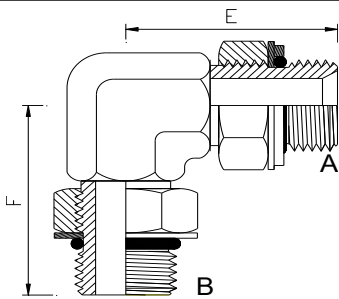

Item No	A-BSPP	B-UNO	E	F
1GO9-1617	-16 1-11	-17 1.1/16-12	53	52
1GO9-1621	-16 1-11	-21 1.5/16-12	53	52

1J9
JIC Male x JIC Male 90 Elbow

SAE Specification

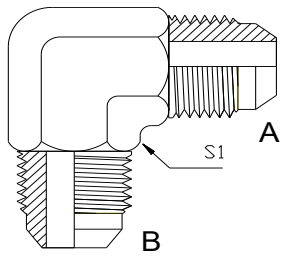

Item No	A-JIC	B-JIC	S1
1J9-0707	-07 7/16-20	-07 7/16-20	11.1
1J9-0808	-08 1/2-20	-08 1/2-20	14.3
1J9-0908	-09 9/16-18	-08 1/2-20	14.3
1J9-0907	-09 9/16-18	-07 7/16-20	14.3
1J9-0909	-09 9/16-18	-09 9/16-18	14.3
1J9-1209	-12 3/4-16	-09 9/16-18	19.1
1J9-1212	-12 3/4-16	-12 3/4-16	19.1
1J9-1412	-14 7/8-14	-12 3/4-16	22.2
1J9-1414	-14 7/8-14	-14 7/8-14	22.2
1J9-1712	-17 1.1/16-12	-12 3/4-16	27.0
1J9-1714	-17 1.1/16-12	-14 7/8-14	27.0
1J9-1717	-17 1.1/16-12	-17 1.1/16-12	27.0
1J9-1919	-19 1.3/16-12	-19 1.3/16-12	33.3
1J9-2117	-21 1.5/16-12	-17 1.1/16-12	33.3
1J9-2121	-21 1.5/16-12	-21 1.5/16-12	33.3
1J9-2626	-26 1.5/8-12	-26 1.5/8-12	41.3
1J9-3030	-30 1.7/8-12	-30 1.7/8-12	47.6
1J9-4040	-40 2.1/2-12	-40 2.1/2-12	63.5

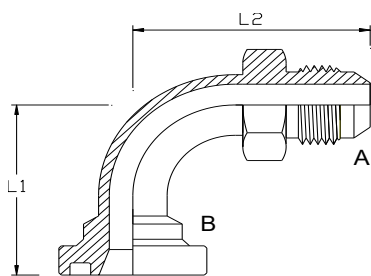
1JFL9
JIC Male x SAE Cd 61 Flange 90 Swept Bend

Item No	A-JIC	B-CD61	L1	L2
1JFL9-1208	-12 3/4-12	-08 1/2	46	57
1JFL9-1212	-12 3/4-12	-12 3/4	47	60
1JFL9-1712	-17 1.1/16-12	-12 3/4	54	73
1JFL9-1716	-17 1.1/16-12	-16 1	54	73
1JFL9-1720	-17 1.1/16-12	-20 1.1/4	55	73
1JFL9-2112	-21 1.5/16-12	-12 3/4	66	86
1JFL9-2116	-21 1.5/16-12	-16 1	66	86
1JFL9-2120	-21 1.5/16-12	-20 1.1/4	66	86
1JFL9-2124	-21 1.5/16-12	-24 1.1/2	68	86
1JFL9-2620	-26 1.5/8-12	-20 1.1/4	77	101
1JFL9-2624	-26 1.5/8-12	-24 1.1/2	77	101
1JFL9-2632	-26 1.5/8-12	-32 2	77	101
1JFL9-3024	-30 1.7/8-12	-24 1.1/2	93	116
1JFL9-3032	-30 1.7/8-12	-32 2	93	116
1JFL9-4032	-40 2.1/2-12	-32 2	115	168

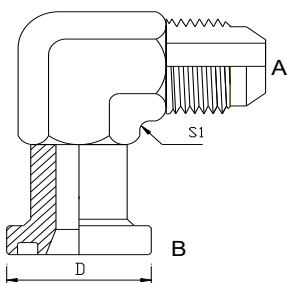
1JFL9C
JIC Male x SAE Cd 61 Flange 90 Elbow

Item No	A-JIC	CD 61	L1	L2
1JFL9C-1208	-12 3/4-16	-08 1/2	38	38
1JFL9C-1712	-17 1.1/16-12	-12 3/4	42	45
1JFL9C-1716	-17 1.1/16-12	-16 1	45	50
1JFL9C-2116	-21 1.5/16-12	-16 1	45	50
1JFL9C-2620	-26 1.5/8-12	-20 1.1/4	50	59
1JFL9C-3024	-30 1.7/8-12	-24 1.1/2	76	76
1JFL9C-3032	-30 1.7/8-12	-32 2	108	80

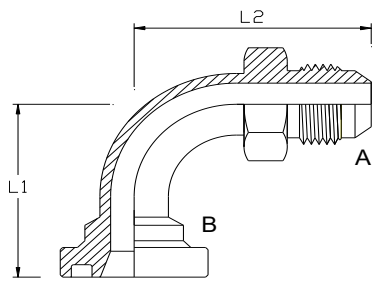
1JFLH9
JIC Male x SAE Cd 62 Flange 90 Swept Bend

Item No	A-JIC	B-CD62	L1	L2
1JFLH9-1208	-12 3/4-16	-08 1/2	47	60
1JFLH9-1212	-12 3/4-12	-12 3/4	51	60
1JFLH9-1712	-17 1.1/16-12	-12 3/4	58	73
1JFLH9-1716	-17 1.1/16-12	-16 1	61	73
1JFLH9-1720	-17 1.1/16-12	-20 1.1/4	70	73
1JFLH9-2112	-21 1.5/16-12	-12 3/4	70	86
1JFLH9-2116	-21 1.5/16-12	-16 1	73	86
1JFLH9-2120	-21 1.5/16-12	-20 1.1/4	77	86
1JFLH9-2124	-21 1.5/16-12	-20 1.1/4	77	86
1JFLH9-2620	-26 1.5/8-12	-20 1.1/4	82	86
1JFLH9-2624	-26 1.5/8-12	-24 1.1/2	96	101
1JFLH9-3020	-30 1.7/8-12	-20 1.1/4	88	101
1JFLH9-3024	-30 1.7/8-12	-24 1.1/2	109	116
1JFLH9-3032	-30 1.7/8-12	-32 2	122	116
1JFLH9-4032	-40 2.1/2-12	-32 2	126	168

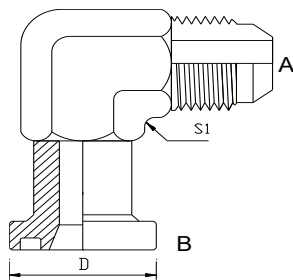
1JFLH9C
JIC Male x SAE Cd 62 Flange 90 Elbow

Item No	A-JIC	B-CD62	L1	L2
1JFLH9C-1208	-12 3/4-16	-08 1/2	39	30
1JFLH9C-1412	-14 7/8-14	-12 3/4	48	48
1JFLH9C-1712	-17 1.1/16-12	-12 3/4	48	48
1JFLH9C-1716	-17 1.1/16-12	-16 1	60	48
1JFLH9C-2116	-21 1.5/16-12	-16 1	60	60
1JFLH9C-2620	-26 1.5/8-12	-20 1.1/4	68	68
1JFLH9C-3024	-30 1.7/8-12	-24 1.1/2	76	76
1JFLH9C-4032	-40 2.1/2-12	-32 2	108	80

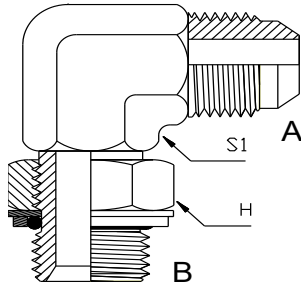
1JG9
JIC Male x BSPP Male 90 Elbow

Item No	A-JIC	B-BSPP	S1	H
1JG9-0702	-07 7/16-20	-02 1/8-28	11	14
1JG9-0704	-07 7/16-20	-04 1/4-19	14	19
1JG9-0706	-07 7/16-20	-06 3/8-19	19	22
1JG9-0708	-07 7/16-20	-08 1/2-14	22	27
1JG9-0804	-08 1/2-20	-04 1/4-19	14	19
1JG9-0902	-09 9/16-18	-02 1/8-28	14	14
1JG9-0904	-09 9/16-18	-04 1/4-19	14	19
1JG9-0906	-09 9/16-18	-06 3/8-19	19	22
1JG9-0908	-09 9/16-18	-08 1/2-14	22	27
1JG9-0912	-09 9/16-18	-12 3/4-14	27	32
1JG9-1204	-12 3/4-16	-04 1/4-19	19	19
1JG9-1206	-12 3/4-16	-06 3/8-19	19	22
1JG9-1208	-12 3/4-16	-08 1/2-14	22	27
1JG9-1212	-12 3/4-16	-12 3/4-14	27	32
1JG9-1406	-14 7/8-14	-06 3/8-19	22	22
1JG9-1408	-14 7/8-14	-08 1/2-14	22	27
1JG9-1412	-14 7/8-14	-12 3/4-14	27	36
1JG9-1708	-17 1.1/16-12	-08 1/2-14	27	27
1JG9-1712	-17 1.1/16-12	-12 3/4-14	27	32
1JG9-1716	-17 1.1/16-12	-16 1-11	33	41
1JG9-1720	-17 1.1/16-12	-20 1.1/4-11	41	50
1JG9-2112	-21 1.5/16-12	-12 3/4-14	33	32
1JG9-2116	-21 1.5/16-12	-16 1-11	33	41
1JG9-2120	-21 1.5/16-12	-20 1.1/4-11	41	50
1JG9-2124	-21 1.5/16-12	-24 1.1/2-11	48	55
1JG9-2616	-26 1.5/8-12	-16 1-11	41	41
1JG9-2620	-26 1.5/8-12	-20 1.1/4-11	41	50
1JG9-2624	-26 1.5/8-12	-24 1.1/2-11	48	55
1JG9-3020	-30 1.7/8-12	-20 1.1/4-11	48	50
1JG9-3024	-30 1.7/8-12	-24 1.1/2-11	48	55
1JG9-4032	-40 2.1/2-12	-32 2-12	63	70

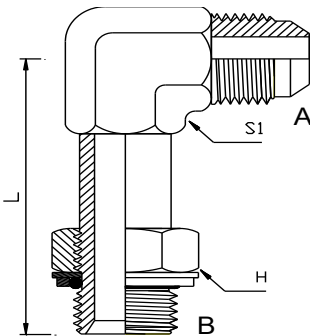
1JG9L
JIC Male x BSPP Male 90 Elbow Long

Item No	A-JIC	B-BSPP	DL	S1	H
1JG9L-0906	-09 9/16-18	-06 3/8-19	63	19	22
1JG9L-1206	-12 3/4-16	-06 3/8-19	63	19	22
1JG9L-1208	-12 3/4-16	-08 1/2-14	74	22	27
1JG9L-1408	-14 7/8-14	-08 1/2-14	74	22	27
1JG9L-1712	-17 1.1/16-12	-12 3/4-14	85	27	36
1JG9L-2116	-21 1.5/16-12	-16 1-11	94	33	41

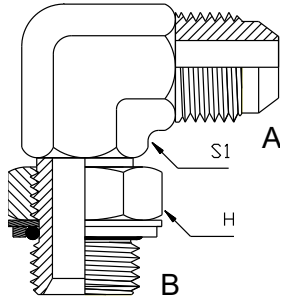
1JM9
JIC Male x Metric Male 90 Elbow

Item No	A-JIC	B-METRIC	S1	H
1JM9-0710	-07 7/16-20	-10 M10x1.5		
1JM9-0712	-07 7/16-20	-12 M12x1.5		
1JM9-0714	-07 7/16-20	-14 M14x1.5		
1JM9-0914	-09 9/16-18	-14 M14x1.5		
1JM9-0916	-09 9/16-18	-16 M16x1.5		
1JM9-0918	-09 9/16-18	-18 M18x1.5		
1JM9-0922	-09 9/16-18	-22 M22x1.5		
1JM9-1216	-12 3/4-16	-16 M16x1.5		
1JM9-1218	-12 3/4-16	-18 M18x1.5		
1JM9-1422	-14 7/8-14	-22 M22x1.5		
1JM9-1727	-17 1.1/16-12	-27 M27x2.0		
1JM9-2133	-21 1.5/16-12	-33 M33x2.0		

1JN9
JIC Male x NPT Male 90 Elbow

SAE Specification

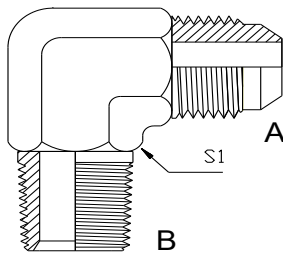

Item No	A-JIC	B-NPT	S1
1JN9-0502	-05 5/16-24	-02 1/8-27	11.1
1JN9-0602	-06 3/8-24	-02 1/8-27	11.1
1JN9-0702	-07 7/16-20	-02 1/8-27	11.1
1JN9-0702-E29	-07 7/16-20	-02 1/8-27	11.1
1JN9-0702-E39	-07 7/16-20	-02 1/8-27	11.1
1JN9-0702-E58	-07 7/16-20	-02 1/8-27	11.1
1JN9-0704	-07 7/16-20	-04 1/4-18	14.3
1JN9-0704-E39	-07 7/16-20	-04 1/4-18	14.3
1JN9-0704-E52	-07 7/16-20	-04 1/4-18	14.3
1JN9-0706	-07 7/16-20	-06 3/8-18	19.1
1JN9-0708	-07 7/16-20	-08 1/2-14	22.2
1JN9-0802	-08 1/2-20	-02 1/8-27	14.3
1JN9-0804	-08 1/2-20	-04 1/4-18	14.3
1JN9-0806	-08 1/2-20	-06 3/8-18	19.1
1JN9-0902	-09 9/16-18	-02 1/8-27	14.3
1JN9-0904	-09 9/16-18	-04 1/4-18	14.3
1JN9-0904-E40	-09 9/16-18	-04 1/4-18	14.3
1JN9-0906	-09 9/16-18	-06 3/8-18	19.1
1JN9-0908	-09 9/16-18	-08 1/2-14	22.2
1JN9-0912	-09 9/16-18	-12 3/4-14	27.0
1JN9-1204	-12 3/4-16	-04 1/4-18	19.1
1JN9-1206	-12 3/4-16	-06 3/8-18	19.1
1JN9-1208	-12 3/4-16	-08 1/2-14	22.2
1JN9L-1208	-12 3/4-16	-08 1/2-14	22.2
1JN9LL-1208	-12 3/4-16	-08 1/2-14	22.2
1JN9-1212	-12 3/4-16	-12 3/4-14	27.0
1JN9-1216	-12 3/4-16	-16 1-11	33.3
1JN9-1406	-14 7/8-14	-06 3/8-18	22.2
1JN9-1408	-14 7/8-14	-08 1/2-14	22.2
1JN9-1412	-14 7/8-14	-12 3/4-14	27.0
1JN9-1416	-14 7/8-14	-16 1-11	33.3
1JN9-1706	-17 1.1/16-12	-06 3/8-18	27.0
1JN9-1708	-17 1.1/16-12	-08 1/2-14	27.0
1JN9-1712	-17 1.1/16-12	-12 3/4-14	27.0
1JN9-1716	-17 1.1/16-12	-16 1-11	33.3
1JN9-1720	-17 1.1/16-12	-20 1.1/4-11.5	41.3
1JN9-2108	-21 1.5/16-12	-08 1/2-14	33.3
1JN9-2112	-21 1.5/16-12	-12 3/4-14	33.3
1JN9-2116	-21 1.5/16-12	-16 1-11	33.3
1JN9-2120	-21 1.5/16-12	-20 1.1/4-11.5	41.3
1JN9-2124	-21 1.5/16-12	-24 1.1/2-11.5	47.6
1JN9-2616	-26 1.5/8-12	-16 1-11.5	41.3
1JN9-2620	-26 1.5/8-12	-20 1.1/4-11.5	47.6
1JN9-2624	-26 1.5/8-12	-24 1.1/2-11.5	47.6
1JN9-3020	-30 1.7/8-12	-20 1.1/4-11.5	47.6
1JN9-3024	-30 1.7/8-12	-24 1.1/2-11.5	47.6
1JN9-3032	-30 1.7/8-12	-32 2-11.5	63.5
1JN9-4024	-40 2.1/2-12	-24 1.1/2-11.5	63.5
1JN9-4032	-40 2.1/2-12	-32 2-11.5	63.5

1JO9
JIC Male x UNO Male 90 Elbow

SAE Specification

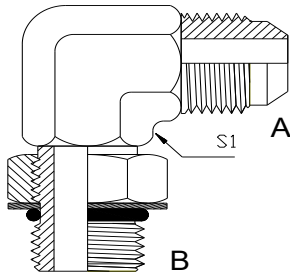

Item No	A-JIC	B-UNO	S1	H
1JO9-0707	-07 7/16-20	-07 7/16-20	11.1	14.3
1JO9-0708	-07 7/16-20	-08 1/2-20	14.3	15.9
1JO9-0709	-07 7/16-20	-09 9/16-18	14.3	17.5
1JO9-0712	-07 7/16-20	-12 3/4-16	19.1	19.1
1JO9-0714	-07 7/16-20	-14 7/8-14	22.2	27.0
1JO9-0717	-07 7/16-20	-17 1.1/16-12	27.0	31.8
1JO9-0808	-08 1/2-20	-08 1/2-20	14.3	15.9
1JO9-0809	-08 1/2-20	-09 9/16-18	14.3	17.5
1JO9-0907	-09 9/16-18	-07 7/16-20	14.3	14.3
1JO9-0908	-09 9/16-18	-08 1/2-20	14.3	15.9
1JO9-0909	-09 9/16-18	-09 9/16-18	14.3	17.5
1JO9-0912	-09 9/16-18	-12 3/4-16	19.1	22.2
1JO9-0914	-09 9/16-18	-14 7/8-14	22.2	27.0
1JO9-0917	-09 9/16-18	-17 1.1/16-12	27.0	31.8
1JO9-1207	-12 3/4-16	-07 7/16-20	19.1	22.2
1JO9-1209	-12 3/4-16	-09 9/16-18	19.1	17.5
1JO9-1212	-12 3/4-16	-12 3/4-16	19.1	22.2
1JO9-1214	-12 3/4-16	-14 7/8-14	22.2	27.0
1JO9-1217	-12 3/4-16	-17 1.1/16-12	27.0	31.8
1JO9-1221	-12 3/4-16	-21 1.5/16-12	33.3	38.1
1JO9-1409	-14 7/8-14	-09 9/16-18	22.2	17.5
1JO9-1412	-14 7/8-14	-12 3/4-16	22.2	22.2
1JO9-1414	-14 7/8-14	-14 7/8-14	22.2	27.0
1JO9-1417	-14 7/8-14	-17 1.1/16-12	27.0	31.8
1JO9-1709	-17 1.1/16-12	-09 9/16-18	27.0	17.5
1JO9-1712	-17 1.1/16-12	-12 3/4-16	27.0	22.2
1JO9-1714	-17 1.1/16-12	-14 7/8-14	27.0	27.0
1JO9-1717	-17 1.1/16-12	-17 1.1/16-12	27.0	31.8
1JO9-1719	-17 1.1/16-12	-19 1.3/16-12	33.3	34.9
1JO9-1721	-17 1.1/16-12	-21 1.5/16-12	33.3	38.1
1JO9-2112	-21 1.5/16-12	-14 7/8-14	33.3	22.2
1JO9-2114	-21 1.5/16-12	-14 7/8-14	33.3	27.0
1JO9-2117	-21 1.5/16-12	-17 1.1/16-12	33.3	31.8
1JO9-2119	-21 1.5/16-12	-19 1.3/16-12	33.3	34.9
1JO9-2121	-21 1.5/16-12	-21 1.5/16-12	33.3	38.1
1JO9-2126	-21 1.5/16-12	-26 1.5/8-12	41.3	47.6
1JO9-2621	-26 1.5/8-12	-21 1.5/16-12	41.3	38.1
1JO9-2626	-26 1.5/8-12	-26 1.5/8-12	41.3	47.6
1JO9-2630	-26 1.5/8-12	-30 1.7/8-12	47.6	54.0
1JO9-3026	-30 1.7/8-12	-26 1.5/8-12	47.6	47.6
1JO9-3030	-30 1.7/8-12	-30 1.7/8-12	47.6	54.0
1JO9-4040	-40 2.1/2-12	-40 2.1/2-12	63.5	69.9

1JO9L
JIC Male x UNO Male 90 Extended Elbow

SAE Specification

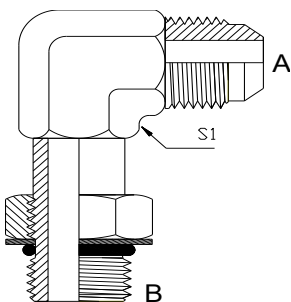

Item No	A-JIC	B-UNO	DL	S1	H
1JO9L-0707	-07 7/16-20	-07 7/16-20	39	11.1	14.3
1JO9L-0909	-09 9/16-18	-09 9/16-18	42	14.3	17.5
1JO9L-0912	-09 9/16-18	-12 3/4-16	50	19.1	22.2
1JO9L-0914	-09 9/16-18	-14 7/8-14	57	22.2	25.4
1JO9L-1209	-12 3/4-16	-09 9/16-18	47	17.5	17.5
1JO9L-1212	-12 3/4-16	-12 3/4-16	50	19.1	22.2
1JO9L-1214	-12 3/4-16	-14 7/8-14	57	22.2	25.4
1JO9L-1414	-14 7/8-14	-14 7/8-14	57	22.2	25.4
1JO9L-1714	-17 1.1/16-12	-14 7/8-14	62	27.0	25.4
1JO9L-1717	-17 1.1/16-12	-17 1.1/16-12	62	27.0	31.8
1JO9L-2117	-21 1.5/16-12	-17 1.1/16-12	78	33.3	31.8
1JO9L-2121	-21 1.5/16-12	-21 1.5/16-12	78	33.3	38.1
1JO9LL-0707	-07 7/16-20	-07 7/16-20	44	11.1	14.3
1JO9LL-0909	-09 9/16-18	-09 9/16-18	53	14.3	17.5
1JO9LL-0912	-09 9/16-18	-12 3/4-16	63	19.1	22.2
1JO9LL-1209	-12 3/4-16	-09 9/16-18	63	19.1	17.5
1JO9LL-1212	-12 3/4-16	-12 3/4-16	63	19.1	22.2
1JO9LL-1214	-12 3/4-16	-14 7/8-14	73	22.2	25.4
1JO9LL-1414	-14 7/8-14	-14 7/8-14	73	22.2	25.4
1JO9LL-1714	-17 1.1/16-12	-14 7/8-14	85	27.0	25.7
1JO9LL-1717	-17 1.1/16-12	-17 1.1/16-12	85	27.0	31.8
1JO9LL-2121	-21 1.5/16-12	-21 1.5/16-12	94	33.3	38.1

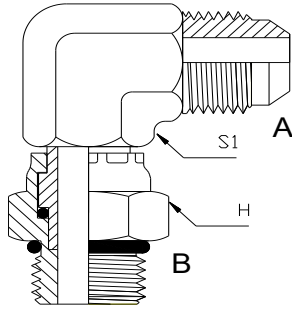
1JO9X
JIC Male x UNO Male Swivel 90 Elbow

Item No	A-JIC	B-UNO	S1	H
1JO9X-1212	-12 3/4-16	-12 3/4-16	19.1	22.2
1JO9X-1214	-12 3/4-16	-14 7/8-14	22.2	25.4
1JO9X-1414	-14 7/8-14	-14 7/8-14	22.2	25.4
1JO9X-1717	-17 1.1/16-12	-17 1.1/16-12	27.0	31.8

Note - The swivel function is for assembly only.
These fittings cannot be used as live swivels.

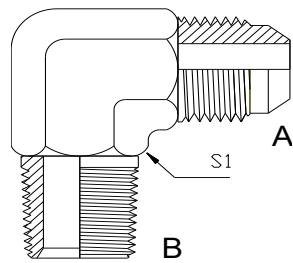
1JT9
JIC Male x BSPT Male 90 Elbow

Item No	A-JIC	B-BSPT	S1
1JT9-0702	-07 7/16-20	-02 1/8-28	11
1JT9-0702-E29	-07 7/16-20	-02 1/8-28	11
1JT9-0702-E39	-07 7/16-20	-02 1/8-28	11
1JT9-0702-E49	-07 7/16-20	-02 1/8-28	11
1JT9-0702-E58	-07 7/16-20	-02 1/8-28	11
1JT9-0704	-07 7/16-20	-04 1/4-19	14
1JT9-0704-E40	-07 7/16-20	-04 1/4-19	14
1JT9-0706	-07 7/16-20	-06 3/8-19	19
1JT9-0708	-07 7/16-20	-08 1/2-14	22
1JT9-0802	-08 1/2-20	-02 1/8-28	14
1JT9-0804	-08 1/2-20	-04 1/4-19	14
1JT9-0806	-08 1/2-20	-06 3/8-19	19
1JT9-0902	-09 9/16-18	-02 1/8-28	14
1JT9-0904	-09 9/16-18	-04 1/4-19	14
1JT9-0906	-09 9/16-18	-06 3/8-19	19
1JT9-0908	-09 9/16-18	-08 1/2-14	22
1JT9-0912	-09 9/16-18	-12 3/4-14	27
1JT9-1204	-12 3/4-16	-04 1/4-19	19
1JT9-1206	-12 3/4-16	-06 3/8-19	19
1JT9-1208	-12 3/4-16	-08 1/2-14	22
1JT9-1212	-12 3/4-16	-12 3/4-14	27
1JT9-1216	-12 3/4-16	-16 1-11	33
1JT9-1406	-14 7/8-14	-06 3/8-19	22
1JT9-1408	-14 7/8-14	-08 1/2-14	22
1JT9-1412	-14 7/8-14	-12 3/4-14	27
1JT9-1416	-14 7/8-14	-16 1-11	33
1JT9-1708	-17 1.1/16-12	-08 1/2-14	27
1JT9-1712	-17 1.1/16-12	-12 3/4-14	27
1JT9-1716	-17 1.1/16-12	-16 1-11	33
1JT9-1720	-17 1.1/16-12	-20 1.1/4-11	41
1JT9-2112	-21 1.5/16-12	-12 3/4-14	33
1JT9-2116	-21 1.5/16-12	-16 1-11	33
1JT9-2120	-21 1.5/16-12	-20 1.1/4-11	41
1JT9-2124	-21 1.5/16-12	-24 1.1/2-11	48
1JT9-2616	-26 1.5/8-12	-16 1-11	41
1JT9-2620	-26 1.5/8-12	-20 1.1/4-11	41
1JT9-2624	-26 1.5/8-12	-24 1.1/2-11	48
1JT9-3020	-30 1.7/8-12	-20 1.1/4-11	48
1JT9-3024	-30 1.7/8-12	-24 1.1/2-11	48
1JT9-4032	-40 2.1/2-12	-32 2-11	63

1JT9X
JIC Male x BSPT Male Swivel 90 Elbow

Item No	A-JIC	B-BSPT	S1
1JT9X-0906	-09 9/16-18	-06 3/8-19	19
1JT9X-1206	-12 3/4-16	-06 3/8-19	19
1JT9X-1208	-12 3/4-16	-08 1/2-14	22
1JT9X-1408	-14 7/8-14	-08 1/2-14	22

1N9
NPT Male x NPT Male 90 Elbow

SAE Specification

Item No	A-NPT	B-NPT	S1
1N9-0202	-02 1/8-27	-02 1/8-27	11.1
1N9-0402	-04 1/4-18	-02 1/8-27	14.3
1N9-0404	-04 1/4-18	-04 1/4-18	14.3
1N9-0602	-06 3/8-18	-02 1/8-27	19.1
1N9-0604	-06 3/8-18	-04 1/4-18	19.1
1N9-0606	-06 3/8-18	-06 3/8-18	19.1
1N9-0804	-08 1/2-14	-04 1/4-18	22.2
1N9-0806	-08 1/2-14	-06 3/8-18	22.2
1N9-0808	-08 1/2-14	-08 1/2-14	22.2
1N9-1206	-12 3/4-14	-06 3/8-18	27.0
1N9-1208	-12 3/4-14	-08 1/2-14	27.0
1N9-1212	-12 3/4-14	-12 3/4-14	27.0
1N9-1608	-16 1-11.5	-08 1/2-14	33.3
1N9-1612	-16 1-11.5	-12 3/4-14	33.3
1N9-1616	-16 1-11.5	-16 1-11.5	33.3
1N9-2020	-20 1.1/4-11.5	-20 1.1/4-11.5	41.3
1N9-2424	-24 1.1/2-11.5	-24 1.1/2-11.5	47.6
1N9-3232	-32 2-11.5	-32 2-11.5	63.5

1N09
NPT Male x UNO Male 90 Elbow

SAE Specification

Item No	A-NPT	B-UNO	S1	H
1N09-0207	-04 1/8-27	-07 7/16-20	11.1	14.3
1N09-0407	-04 1/4-18	-07 7/16-20	14.3	14.3
1N09-0409	-04 1/4-18	-09 9/16-18	14.3	19.1
1N09-0609	-06 3/8-18	-09 9/16-18	19.1	19.1
1N09-0612	-06 3/8-18	-12 3/4-16	19.1	22.2
1N09-0812	-08 1/2-14	-12 3/4-16	22.2	22.2
1N09-0814	-08 1/2-14	-14 7/8-14	22.2	25.4
1N09-1214	-12 3/4-14	-14 7/8-14	27.0	25.4
1N09-1217	-12 3/4-14	-17 1.1/16-12	27.0	31.8
1N09-1621	-16 1-11.5	-21 1.5/16-12	33.3	38.1

109
UNO Male x UNO Male 90 Elbow

SAE Specification

Item No	A-UNO	B-UNO	S1	H
109-0909	-09 9/16-18	-09 9/16-18	14.3	17.5
109-0912	-09 9/16-18	-12 3/4-16	19.1	22.2
109-1212	-12 3/4-16	-12 3/4-16	19.1	22.2
109-1414	-14 7/8-14	-14 7/8-14	22.2	25.4
109-1717	-17 1.1/16-12	-17 1.1/16-12	27.0	31.8

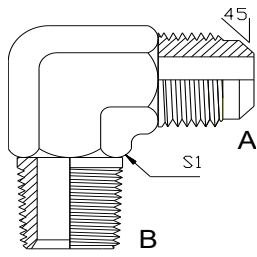
1PT9
SAE Male x BSPT Male 90 Elbow

Item No	A-BSPT	B-BSPT	S1
1PT9-1004	-10 5/8-18	-04 1/4-19	19
1PT9-1006	-10 5/8-18	-06 3/8-19	19

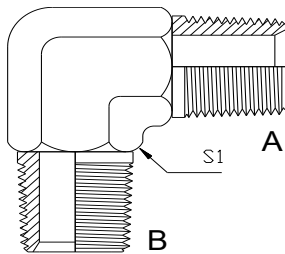
1T9
BSPT Male x BSPT Male 90 Elbow

Item No	A-BSPT	B-BSPT	S1
1T9-0202	-02 1/8-28	-02 1/8-28	11
1T9-0402	-04 1/4-19	-02 1/8-28	14
1T9-0404	-04 1/4-19	-04 1/4-19	14
1T9-0604	-06 3/8-19	-04 1/4-19	14
1T9-0606	-06 3/8-19	-06 3/8-19	19
1T9-0804	-08 1/2-14	-04 1/4-19	22
1T9-0806	-08 1/2-14	-06 3/8-19	22
1T9-0808	-08 1/2-14	-08 1/2-14	22
1T9-1208	-12 3/4-14	-08 1/2-14	27
1T9-1212	-12 3/4-14	-12 3/4-14	27
1T9-1612	-16 1-11	-12 3/4-14	33
1T9-1616	-16 1-11	-16 1-11	33
1T9-2012	-20 1.1/4-11	-12 3/4-14	41
1T9-2016	-20 1.1/4-11	-16 1-11	41
1T9-2020	-20 1.1/4-11	-20 1.1/4-11	41
1T9-2424	-24 1.1/2-11	-24 1.1/2-11	48
1T9-3232	-32 2-11	-32 2-11	63

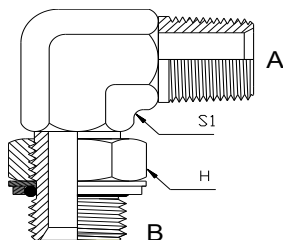
1TG9
BSPT Male x BSPP Male 90 Elbow

Item No	A-BSPT	B-BSPP	S1	H
1TG9-0202	-02 1/8-28	-02 1/8-28	11	14
1TG9-0404	-04 1/4-19	-04 1/4-19	14	19
1TG9-0406	-04 1/4-19	-06 3/8-19	19	22
1TG9-0604	-06 3/8-19	-04 1/4-19	19	19
1TG9-0606	-06 3/8-19	-06 3/8-19	19	22
1TG9-0608	-06 3/8-19	-08 1/2-14	22	27
1TG9-0806	-08 1/2-14	-06 3/8-19	22	22
1TG9-0808	-08 1/2-14	-08 1/2-14	22	27
1TG9-0812	-08 1/2-14	-12 3/4-14	27	32
1TG9-1208	-12 3/4-14	-08 1/2-14	27	27
1TG9-1212	-12 3/4-14	-12 3/4-14	27	32
1TG9-1216	-12 3/4-14	-16 1-11	33	41
1TG9-1612	-16 1-11	-12 3/4-14	33	27
1TG9-1616	-16 1-11	-16 1-11	33	41
1TG9-1620	-16 1-11	-20 1.1/4-11	41	50
1TG9-2020	-20 1.1/4-11	-20 1.1/4-11	41	50
1TG9-2424	-24 1.1/2-11	-24 1.1/2-11	48	55

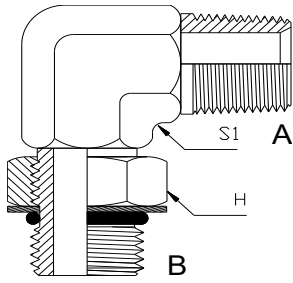
1T09
BSPT Male x UNO Male 90 Elbow

Item No	A-BSPT	B-UNO	S1	H
1T09-0407	-04 1/4-19	-07 7/16-20	14	14.3
1T09-0409	-04 1/4-19	-09 9/16-18	14	17.5
1T09-0412	-04 1/4-19	-12 3/4-16	19	22.2
1T09-0609	-06 3/8-19	-09 9/16-18	19	17.5
1T09-0612	-06 3/8-19	-12 3/4-16	19	22.2
1T09-0614	-06 3/8-19	-14 7/8-14	22	25.4
1T09-0812	-08 1/2-14	-12 3/4-16	22	22.2
1T09-0814	-08 1/2-14	-14 7/8-14	22	25.4
1T09-0817	-08 1/2-14	-17 1.1/16-12	27	31.8
1T09-1214	-12 3/4-14	-14 7/8-14	27	25.4
1T09-1217	-12 3/4-14	-17 1.1/16-12	27	31.8
1T09-1221	-12 3/4-14	-21 1.5/16-12	33	38.1
1T09-1617	-16 1-11	-17 1.1/16-12	33	31.8
1T09-1621	-16 1-11	-21 1.5/16-12	33	38.1
1T09-1626	-16 1-11	-26 1.5/8-12	41	47.6
1T09-2026	-20 1.1/4-11	-26 1.5/8-12	41	47.6

2F9
ORFS Male x ORFS Female 90 Elbow

SAE Specification

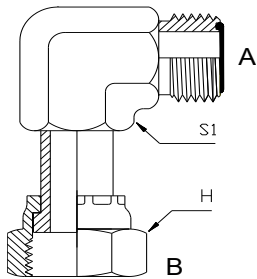

Item No	A-ORFS	B-ORFS	S1	H
2F9-0909	-09 9/16-18	-09 9/16-18	14.3	17.4
2F9-1111	-11 11/16	-11 11/16-16	19.1	20.6
2F9-1313	-13 13*16-16	-13 13/16-16	19.1	23.8
2F9-1616	-16 1-14	-16 1-14	27.0	28.6
2F9-1919	-19 1.3/16-12	-19 1.3/16-16	30.2	34.9
2F9-2323	-23 1.7/16-12	-23 1.7/16-12	36.5	41.3
2F9-2727	-27 1.11/16-12	-27 1.11/16-12	41.3	47.6
2F9-3232	-32 2-12	-32 2-12	47.6	57.2

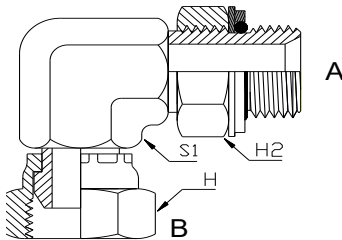
2GB9
BSPP Male x BSPP Female 90 Elbow

Item No	A-BSPP	B-BSPP	S1	H	H2
2GB9-0202	-02 1/8-28	-02 1/8-28	11	14	14
2GB9-0404	-04 1/4-19	-04 1/4-19	14	19	19
2GB9-0606	-06 3/8-19	-06 3/8-19	19	22	22
2GB9-0808	-08 1/2-14	-08 1/2-14	22	27	27
2GB9-1212	-12 3/4-14	-12 3/4-14	27	32	32
2GB9-1216	-12 3/4-14	-16 1-11	33	41 *	32
2GB9-1616	-16 1-11	-16 1-11	33	41 *	41
2GB9-2020	-20 1.1/4-11	-20 1.1/4-11	41	50 *	50
2GB9-2424	-24 1.1/2-11	-24 1.1/2-11	48	55 *	55

2J9
JIC Male x JIC Female 90 Elbow

SAE Specification

Item No	A-JIC	B-JIC	S1	H
2J9-0606	-06 3/8-24	-06 3/8-24	11.1	12.7
2J9-0707	-07 7/16-20	-07 7/16-20	11.1	14.3
2J9-0709	-07 7/16-20	-09 9/16-18	14.3	17.5
2J9-0808	-08 1/2-20	-08 1/2-20	14.3	15.9
2J9-0907	-09 9/16-18	-07 7/16-20	14.3	14.3
2J9-0909	-09 9/16-18	-09 9/16-18	14.3	17.5
2J9-0912	-09 9/16-18	-12 3/4-16	19.1	22.2
2J9-1209	-12 3/4-16	-09 9/16-18	19.1	17.5
2J9-1212	-12 3/4-16	-12 3/4-16	19.1	22.2
2J9-1214	-12 3/4-16	-14 7/8-14	22.2	25.4
2J9-1217	-12 3/4-16	-17 1.1/16-12	27.0	31.8
2J9-1412	-14 7/8-14	-12 3/4-16	22.2	22.2
2J9-1414	-14 7/8-14	-14 7/8-14	22.2	25.4
2J9-1417	-14 7/8-14	-17 1.1/16-12	27.0	31.8
2J9-1712	-17 1.1/16-12	-12 3/4-16	27.0	22.2
2J9-1714	-17 1.1/16-12	-14 7/8-14	27.0	25.4
2J9-1717	-17 1.1/16-12	-17 1.1/16-12	27.0	31.8
2J9-1721	-17 1.1/16-12	-21 1.5/16-12	33.3	38.1
2J9-1919	-19 1.3/16-12	-19 1.3/16-12	33.3	34.9
2J9-2121	-21 1.5/16-12	-21 1.5/16-12	33.3	38.1
2J9-2126	-21 1.5/16-12	-26 1.5/8-12	41.3	50.8
2J9-2626	-26 1.5/8-12	-26 1.5/8-12	41.3	50.8
2J9-3030	-30 1.7/8-12	-30 1.7/8-12	47.6	57.2
2J9-4040	-40 2.1/2-12	-40 2.1/2-12	63.5	76.2

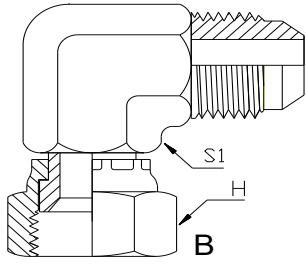
2J9-T
JIC Male x JIC Female 90 Swept Bend

Item No	A-JIC	B-JIC	DL	H1	H
2J9-T-0707	-07 7/16-20	-07 7/16-20	29	12	14.3
2J9-T-0909	-09 9/16-18	-09 9/16-18	39	17	17.5
2J9-T-1212	-12 3/4-16	-12 3/4-16	44	22	22.2
2J9-T-1414	-14 7/8-14	-14 7/8-14	50	24	25.4
2J9-T-1717	-17 1.1/16-12	-17 1.1/16-12	58	30	31.8
2J9-T-2121	-21 1.5/16-12	-21 1.5/16-12	73	36	38 *
2J9-T-2626	-26 1.5/8-12	-26 1.5/8-12	85	42	50 *
2J9-T-3030	-30 1.7/8-12	-30 1.7/8-12	105	52	55 *
2J9-T-4040	-40 2.1/2-12	-40 2.1/2-12	131	66	70 *

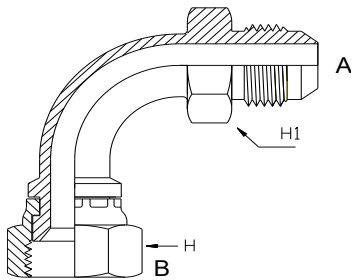

2J9-TL
JIC Male x JIC Female 90 Swept Bend Long

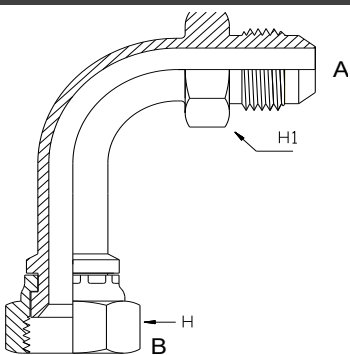
Item No	A-JIC	B-JIC	DL	H1	H
2J9-TL-0707	-07 7/16-20	-07 7/16-20	45	12	14.3
2J9-TL-0909	-09 9/16-18	-09 9/16-18	55	17	17.5
2J9-TL-1212	-12 3/4-16	-12 3/4-16	62	22	22.2
2J9-TL-1414	-14 7/8-14	-14 7/8-14	65	24	25.4
2J9-TL-1717	-17 1.1/16-12	-17 1.1/16-12	91	30	31.8
2J9-TL-2121	-21 1.5/16-12	-21 1.5/16-12	105	36	38 *
2J9-TL-2626	-26 1.5/8-12	-26 1.5/8-12	127	42	50 *
2J9-TL-3030	-30 1.7/8-12	-30 1.7/8-12	138	52	55 *

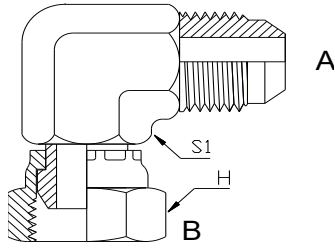

2JB9
JIC Male x BSP Female 90 Elbow

Item No	A-JIC	B-BSP	S1	H
2JB9-0702	-07 7/16-20	-02 1/8-28	11	14
2JB9-0704	-07 7/16-20	-04 1/4-19	14.3	19

2NJ9
NPT Male x JIC Female 90 Elbow

SAE Specification

Item No	A-NPT	B-JIC	S1	H
2NJ9-0207	-04 1/8-27	-07 7/16-20	11.1	14.3
2NJ9-0407	-04 1/4-18	-07 7/16-20	14.3	14.3
2NJ9-0409	-04 1/4-18	-09 9/16-18	14.3	17.5
2NJ9-0412	-04 1/4-18	-12 3/4-16	19.1	22.2
2NJ9-0607	-06 3/8-18	-07 7/16-20	19.1	14.3
2NJ9-0609	-06 3/8-18	-09 9/16-18	19.1	17.5
2NJ9-0612	-06 3/8-18	-12 3/4-16	19.1	22.2
2NJ9-0807	-08 1/2-14	-07 7/16-20	22.2	14.4
2NJ9-0809	-08 1/2-14	-09 9/16-18	22.2	17.5
2NJ9-0812	-08 1/2-14	-12 3/4-16	22.2	22.2
2NJ9-0814	-08 1/2-14	-14 7/8-14	22.2	25.4
2NJ9-0817	-08 1/2-14	-17 1.1/16-12	27.0	31.8
2NJ9-1212	-12 3/4-14	-12 3/4-16	27.0	22.2
2NJ9-1214	-12 3/4-14	-14 7/8-14	27.0	25.4
2NJ9-1217	-12 3/4-14	-17 1.1/16-12	27.0	31.8
2NJ9-1221	-12 3/4-14	-21 1.5/16-12	33.3	38.1
2NJ9-1617	-16 1-11.5	-17 1.1/16-12	33.3	31.8
2NJ9-1621	-16 1-11.5	-21 1.5/16-12	33.3	38.1
2NJ9-2026	-20 1.1/4-11.5	-26 1.5/8-12	41.6	50.8
2NJ9-2430	-24 1.1/2-11.5	-30 1.7/8-12	47.6	57.2
2NJ9-3240	-32 2-11.5	-40 2.1/2-12	63.5	73.0

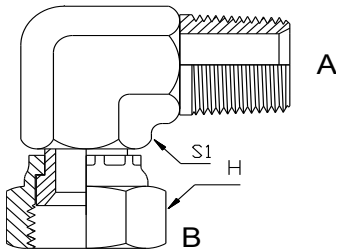
2NU9
NPT Male x NPSM Female 90 Elbow

SAE Specification

Item No	A-NPT	B-NPSM	S1	H
2NU9-0202	-02 1/8-27	-02 1/8-27	11.1	14.3
2NU9-0402	-04 1/4-18	-02 1/8-27	14.3	14.3
2NU9-0404	-04 1/4-18	-04 1/4-18	14.3	17.5
2NU9-0406	-04 1/4-18	-06 3/8-18	19.1	22.2
2NU9-0604	-06 3/8-18	-04 1/4-18	19.1	17.5
2NU9-0606	-06 3/8-18	-06 3/8-18	19.1	22.2
2NU9-0608	-06 3/8-18	-08 1/2-14	22.2	25.4
2NU9-0806	-08 1/2-14	-06 3/8-18	22.2	22.2
2NU9-0808	-08 1/2-14	-08 1/2-14	22.2	25.4
2NU9-0812	-08 1/2-14	-12 3/4-14	27.0	31.8
2NU9-1208	-12 3/4-14	-08 1/2-14	27.0	25.4
2NU9-1212	-12 3/4-14	-12 3/4-14	27.0	31.8
2NU9-1216	-12 3/4-14	-16 1-11.5	33.3	38.1
2NU9-1612	-16 1-11.5	-12 3/4-14	33.3	31.8
2NU9-1616	-16 1-11.5	-16 1-11.5	33.3	38.1
2NU9-2020	-20 1.1/4-11.5	-20 1.1/4-11.5	41.3	47.6
2NU9-2424	-24 1.1/2-11.5	-24 1.1/2-11.5	47.6	54.0
2NU9-3232	-32 2-11.5	-32 2-11.5	63.5	66.7

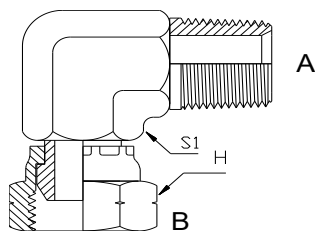

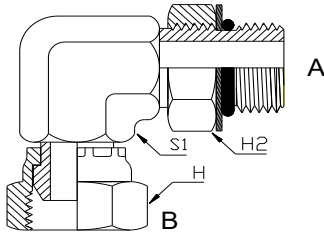
20B9
UNO Male x BSP Female 90 Elbow

Item No	A-UNO	B-BSP	S1	H	H2
20B9-0702	-07 7/16-20	-02 1/8-28	11	14	14.3
20B9-0704	-07 7/16-20	-04 1/4-19	14	19	14.3
20B9-0904	-09 9/16-18	-04 1/4-19	14	19	17.5
20B9-0906	-09 9/16-18	-06 3/8-19	19	22	17.5
20B9-1206	-12 3/4-16	-06 3/8-19	19	22	22.2
20B9-1208	-12 3/4-16	-08 1/2-14	22	27	22.2
20B9-1408	-14 7/8-14	-08 1/2-14	22	27	25.4
20B9-1712	-17 1.1/16-12	-12 3/4-14	27	32	31.8
20B9-2116	-21 1.5/16-12	-16 1-11	33	38	38.1

20F9
UNO Male x ORFS Female 90 Elbow

SAE Specification

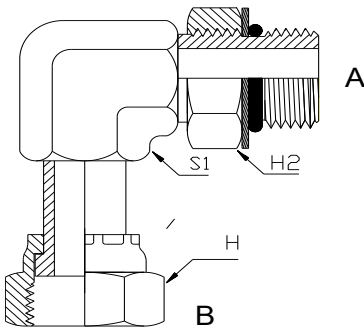

Item No	A-UNO	B-ORFS	S1	H
20F9-0709	-07 7/16-20	-09 9/16-18	15.9	17.5
20F9-0911	-09 9/16-18	-11 11/16-16	19.1	20.6
20F9-1213	-12 3/4-16	-13 13/16-16	23.8	23.8
20F9-1416	-14 7/8-14	-16 1-14	27.0	28.6
20F9-1719	-17 1.1/16-12	-19 1.3/16-12	34.8	34.9
20F9-2123	-21 1.5/16-12	-23 1.7/16-12	41.3	41.3

20J9
UNO Male x JIC Female 90 Elbow

SAE Specification

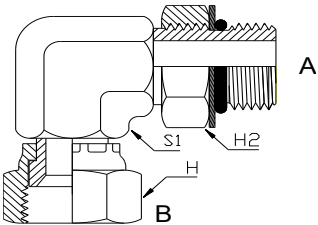

Item No	A-UNO	B-JIC	S1	H2	H
20J9-0707	-07 7/16-20	-07 7/16-20	11.1	14.3	14.3
20J9-0909	-09 9/16-18	-09 9/16-18	14.3	17.5	17.5
20J9-1209	-12 3/4-16	-09 9/16-18	19.1	17.5	22.2
20J9-1212	-12 3/4-16	-12 3/4-16	19.1	22.2	22.2
20J9-1214	-12 3/4-16	-14 7/8-14	22.2	25.4	22.2
20J9-1412	-14 7/8-14	-12 3/4-16	22.2	22.2	25.4
20J9-1414	-14 7/8-14	-14 7/8-14	22.2	25.4	25.4
20J9-1717	-17 1.1/16-12	-17 1.1/16-12	27.0	31.8	31.8
20J9-2121	-21 1.5/16-12	-21 1.5/16-12	33.3	38.1	38.1

20U9
UNO Male x NPSM Female 90 Elbow

SAE Specification

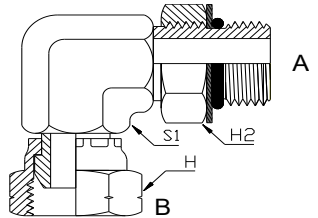

Item No	A-UNO	B-NPSM	S1	H2	H
20U9-0704	-07 7/16-20	-04 1/4-18	14.3	14.3	17.5
20U9-0904	-09 9/16-18	-04 1/4-18	14.3	17.5	22.2
20U9-0906	-09 9/16-18	-06 3/8-18	19.1	17.5	22.2
20U9-1206	-12 3/4-16	-06 3/8-18	19.1	22.2	22.2
20U9-1208	-12 3/4-16	-08 1/2-14	22.2	22.2	25.5
20U9-1408	-14 7/8-14	-08 1/2-14	22.2	25.4	25.4
20U9-1712	-17 1.1/16-12	-12 3/4-14	27.0	31.8	31.8
20U9-2116	-21 1.5/16-12	-16 1-11.5	33.3	38.1	38.1
20U9-2620	-26 1.5/8-12	-20 1.1/4-11.5	41.3	47.6	47.6

2P9
SAE Male x SAE Female 90 Elbow

Item No	A-SAE	B-SAE	S1	H
2P9-1010	-10 5/8-18	-10 5/8-18	19	20
2P9-1717	-17 1.1/16-14	-17 1.1/16-14	27	32

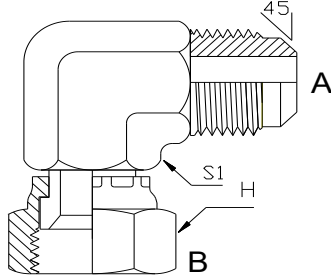
2TB9
BSPT Male x BSPP Female 90 Elbow

Item No	A-BSPT	B-BSPP	S1	H
2TB9-0202	-02 1/8-28	-02 1/8-28	11	14
2TB9-0404	-04 1/4-19	-04 1/4-19	14	19
2TB9-0406	-04 1/4-19	-06 3/8-19	19	22
2TB9-0604	-06 3/8-19	-04 1/4-19	19	19
2TB9-0606	-06 3/8-19	-06 3/8-19	19	22
2TB9-0608	-06 3/8-19	-08 1/2-12	22	27
2TB9-0806	-08 1/2-14	-06 3/8-19	22	42
2TB9-0808	-08 1/2-14	-08 1/2-14	22	27
2TB9-0812	-08 1/2-14	-12 3/4-14	27	27
2TB9-1208	-12 3/4-14	-08 1/2-14	27	32
2TB9-1212	-12 3/4-14	-12 3/4-14	27	32
2TB9-1216	-12 3/4-14	-16 1-11	33	41 *
2TB9-1612	-16 1-11	-12 3/4-14	33	32
2TB9-1616	-16 1-11	-16 1-11	33	41 *
2TB9-2020	-20 1.1/4-11	-20 1.1/4-11	41	50 *
2TB9-2424	-24 1.1/2-11	-24 1.1/2-11	48	55 *
2TB9-3232	-32 2-11	-32 2-11	63	73 *

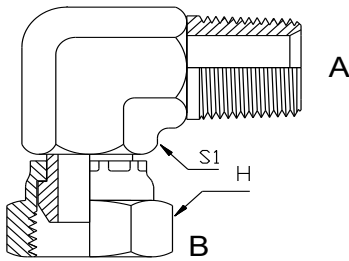
2TB9-T
BSPT Male x BSPP Female 90 Swept Elbow

Item No	A-BSPT	B-BSPP	DL	H1	H
2TB9-T-2024	-20 1.1/4-11	-24 1.1/2-11	138	46	55 *
2TB9-T-3232	-32 2-11	-32 2-11	128	61	73 *

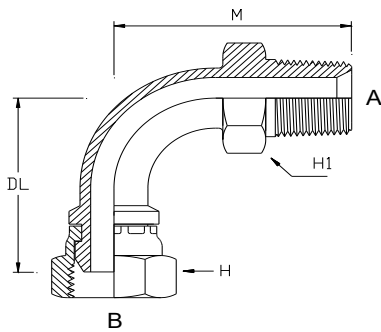

2TJ9
BSPT Male x JIC Female 90 Elbow

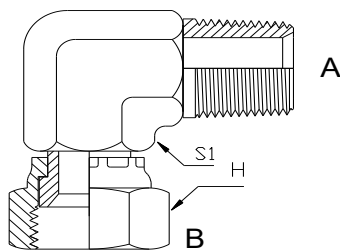
Item No	A-BSPT	B-JIC	S1	H
2TJ9-0207	-02 1/8-28	-07 7/16-20	11	14.3
2TJ9-0209	-02 1/8-28	-09 9/16-18	14	17.5
2TJ9-0407	-04 1/4-19	-07 7/16-20	14	14.3
2TJ9-0409	-04 1/4-19	-09 9/16-18	14	17.5
2TJ9-0609	-06 3/8-19	-09 9/16-18	19	17.5
2TJ9-0612	-06 3/8-19	-12 3/4-16	19	22.2
2TJ9-0614	-06 3/8-19	-14 7/8-14	22	25.4
2TJ9-0812	-08 1/2-14	-12 3/4-16	22	22.2
2TJ9-0814	-08 1/2-14	-14 7/8-14	22	25.4
2TJ9-1217	-12 3/4-14	-17 1.1/16-12	27	31.8
2TJ9-1221	-12 3/4-14	-21 1.5/16-12	33	38 *
2TJ9-1621	-16 1-11	-21 1.5/16-12	33	38 *

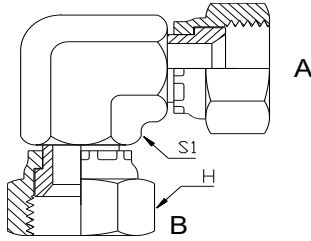

3J9
JIC Female x JIC Female 90 Elbow

SAE Specification



Item No	A-BSPT	B-JIC	S1	H
3J9-0707	-02 1/8-28	-07 7/16-20	11	14.3
3J9-0909	-02 1/8-28	-09 9/16-18	14	17.5
3J9-1212	-06 3/8-19	-12 3/4-16	19	22.2
3J9-1414	-06 3/8-19	-14 7/8-14	22	25.4
3J9-1717	-12 3/4-14	-17 1.1/16-12	27	31.8
3J9-2121	-16 1-11	-21 1.5/16-12	33	41 *

5JN9
JIC Male x NPT Female 90 Elbow

SAE Specification

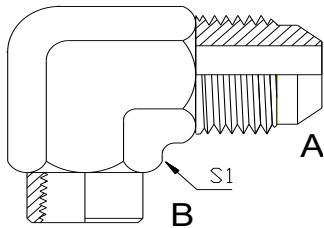

Item No	A-JIC	B-NPT	S1
5JN9-0704	-07 7/16-20	-04 1/4-18	19.1
5JN9-0802	-08 1/2-20	-02 1/8-27	14.3
5JN9-0804	-08 1/2-20	-04 1/4-18	19.1
5JN9-0902	-09 9/16-18	-02 1/8-27	19.1
5JN9-0904	-09 9/16-18	-04 1/4-18	19.1
5JN9-0906	-09 9/16-18	-06 3/8-18	22.2
5JN9-1204	-12 3/4-16	-04 1/4-18	22.2
5JN9-1206	-12 3/4-16	-06 3/8-18	22.2
5JN9-1208	-12 3/4-16	-08 1/2-14	27.0
5JN9-1408	-14 7/8-14	-08 1/2-14	27.0
5JN9-1708	-17 1.1/16-12	-08 1/2-14	33.3
5JN9-1712	-17 1.1/16-12	-12 3/4-14	33.3
5JN9-2116	-21 1.5/16-12	-16 1-11.5	41.3
5JN9-2620	-26 1.5/8-12	-20 1.1/4-11.5	47.6
5JN9-3024	-30 1.7/8-12	-24 1.1/2-11.5	65.0
5JN9-4032	-40 2.1/2-12	-32 2-11.5	71.4

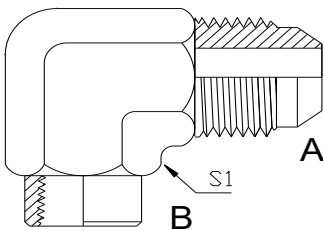
5JT9
JIC Male x BSPT Female 90 Elbow

Item No	A-JIC	B-BSPT	S1
5JT9-0702	-07 7/16-20	-02 1/8-28	14
5JT9-0704	-07 7/16-20	-04 1/4-19	19
5JT9-0904	-09 9/16-18	-04 1/4-19	19
5JT9-1206	-12 3/4-16	-06 3/8-19	22
5JT9-1208	-12 3/4-16	-08 1/2-14	27
5JT9-1712	-17 1.1/16-12	-12 3/4-14	33

5N9
NPT Male x NPT Female 90 Elbow

SAE Specification

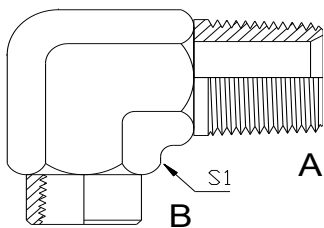

Item No	A-NPT	B-NPT	S1
5N9-0202	-02 1/8-27	-02 1/8-27	14.3
5N9-0204	-02 1/8-27	-04 1/4-18	19.1
5N9-0402	-04 1/4-18	-02 1/8-27	14.3
5N9-0404	-04 1/4-18	-04 1/4-18	19.1
5N9-0406	-04 1/4-18	-06 3/8-18	22.2
5N9-0604	-06 3/8-18	-04 1/4-18	22.2
5N9-0606	-06 3/8-18	-06 3/8-18	22.2
5N9-0608	-06 3/8-18	-08 1/2-14	27.0
5N9-0806	-08 1/2-14	-06 3/8-18	22.2
5N9-0808	-08 1/2-14	-08 1/2-14	27.0
5N9-0812	-08 1/2-14	-12 3/4-14	33.3
5N9-1208	-12 3/4-14	-08 1/2-14	27.0
5N9-1212	-12 3/4-14	-12 3/4-14	33.3
5N9-1616	-16 1-11.5	-16 1-11.5	41.3
5N9-2020	-20 1.1/4-11.5	-20 1.1/4-11.5	47.6
5N9-2424	-24 1.1/2-11.5	-24 1.1/2-11.5	65.0
5N9-3232	-32 2-11.5	-32 2-11.5	71.4

509
UNO Male x UNO Female 90 Elbow

SAE Specification

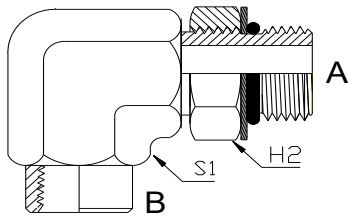

Item No	A-UNO	B-UNO	S1	H
509-0707	-07 7/16-20	-07 7/16-20	19.1	14.3
509-0909	-09 9/16-18	-09 9/16-18	22.2	17.5
509-1212	-12 3/4-16	-12 3/4-16	27	22.2
509-1414	-14 7/8-14	-14 7/8-14	27	25.4
509-1717	-17 1.1/16-12	-17 1.1/16-12	33.3	31.8

50N9
UNO Male x NPT Female 90 Elbow

SAE Specification

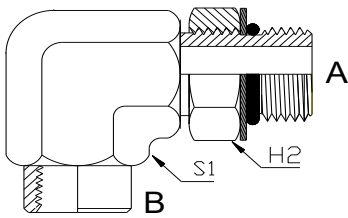

Item No	A-UNO	B-NPT	S1	H
50N9-0906	-09 9/16-18	-06 3/8-18	22.2	17.5
50N9-1206	-12 3/4-16	-06 3/8-18	22.2	22.2
50N9-1208	-12 3/4-16	-08 1/2-14	27.00	22.2
50N9-1408	-14 7/8-14	-08 1/2-14	27.00	25.4
50N9-1708	-17 1.1/16-12	-08 1/2-14	27.00	31.8
50N9-1712	-17 1.1/16-12	-12 3/4-14	33.30	31.8

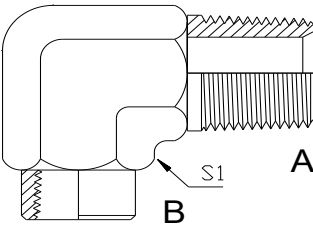
5T9
BSPT Male x BSPT Female 90 Elbow

Item No	A-BSPT	B-BSPT	S1
5T9-0202	-02 1/8-28	-02 1/8-28	16
5T9-0404	-04 1/4-19	-04 1/4-19	19
5T9-0604	-06 3/8-19	-04 1/4-19	24
5T9-0606	-06 3/8-19	-06 3/8-19	24
5T9-0608	-06 3/8-19	-08 1/2-14	30
5T9-0806	-08 1/2-14	-06 3/8-19	24
5T9-0808	-08 1/2-14	-08 1/2-14	30
5T9-0812	-08 1/2-14	-12 3/4-14	33
5T9-1208	-12 3/4-14	-08 1/2-14	30
5T9-1212	-12 3/4-14	-12 3/4-14	33
5T9-1616	-16 1-11	-16 1-11	41
5T9-2020	-20 1.1/4-11	-20 1.1/4-11	48
5T9-2424	-24 1.1/2-11	-24 1.1/2-11	63
5T9-3232	-32 2-11	-32 2-11	70

6F9
ORFS Bulkhead Male x ORFS Male 90 Elbow

SAE Specification

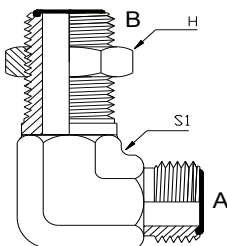

Item No	A-ORFS	B-ORFS	S1	H
6F9-0909	-09 9/16-18	-09 9/16-18	14.3	20.6
6F9-1111	-11 11/16-16	-11 11/16-16	19.1	25.4
6F9-1313	-13 13/16-16	-13 13/16-16	19.1	31.8
6F9-1616	-16 1-14	-16 1-14	27.0	33.3
6F9-1919	-19 1.3/16-12	-19 1.3/16-12	31.2	38.1
6F9-2323	-23 1.7/16-12	-23 1.7/16-12	36.5	44.5
6F9-2727	-27 1.11/16-12	-27 1.11/16-12	47.6	60.3

6J9
JIC Male Bulkhead x JIC Male 90 Elbow

SAE Specification

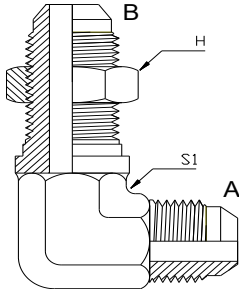

Item No	A-JIC	B-JIC	S1	H
6J9-0707	-07 7/16-20	-07 7/16-20	11.1	17.5
6J9-0808	-08 1/2-20	-08 1/2-20	14.3	19.1
6J9-0909	-09 9/16-18	-09 9/16-18	14.3	20.6
6J9-1212	-12 3/4-16	-12 3/4-16	17.5	25.4
6J9-1414	-14 7/8-14	-14 7/8-14	22.2	28.6
6J9-1717	-17 1.1/16-12	-17 1.1/16-12	27.0	34.9
6J9-2121	-21 1.5/16-12	-21 1.5/16-12	33.3	41.3
6J9-2626	-26 1.5/8-12	-26 1.5/8-12	41.3	47.6
6J9-3030	-30 1.7/8-12	-30 1.7/8-12	47.6	54.0

7N9
NPT Female x NPT Female 90 Elbow

SAE Specification

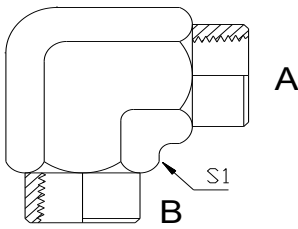

Item No	A-NPT	B-NPT	S1
7N9-0202	-02 1/8-27	-02 1/8-27	14.3
7N9-0404	-04 1/4-18	-04 1/4-18	19.1
7N9-0606	-06 3/8-18	-06 3/8-18	22.2
7N9-0808	-08 1/2-14	-08 1/2-14	27.0
7N9-1212	-12 3/4-14	-12 3/4-14	33.3
7N9-1616	-16 1-11.5	-16 1-11.5	41.3
7N9-2020	-20 1.1/4-11.5	-20 1.1/4-11.5	47.6
7N9-2424	-24 1.1/2-11.5	-24 1.1/2-11.5	65.0
7N9-3232	-32 2-11.5	-32 2-11.5	71.4

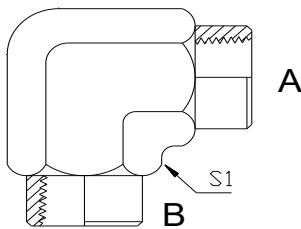
7T9
BSPT Female x BSPT Female 90 Elbow

Item No	A-BSPT	B-BSPT	S1
7T9-0202	-02 1/8-28	-02 1/8-28	16
7T9-0402	-04 1/4-19	-04 1/4-19	19
7T9-0404	-04 1/4-19	-04 1/4-19	19
7T9-0606	-06 3/8-19	-06 3/8-19	24
7T9-0806	-08 1/2-14	-06 3/8-19	27
7T9-0808	-08 1/2-14	-08 1/2-14	27
7T9-1212	-12 3/4-14	-12 3/4-14	33
7T9-1616	-16 1-11	-16 1-11	41
7T9-2020	-20 1.1/4-11	-20 1.1/4-11	50
7T9-2424	-24 1.1/2-11	-24 1.1/2-11	63
7T9-3232	-32 2-11	-32 2-11	70

A1F

ORFS Male Tee

SAE Specification

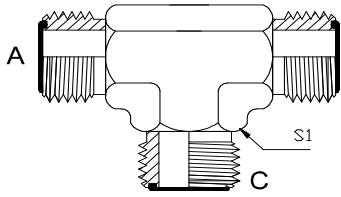

Item No	A-ORFS	B-ORFS	C-ORFS	S1
A1F-090909	-09 9/16-18	-09 9/16-18	-09 9/16-18	14.3
A1F-111111	-11 11/16-16	-11 11/16-16	-11 11/16-16	19.1
A1F-131313	-13 13/16-16	-13 13/16-16	-13 13/16-16	22.2
A1F-161616	-16 1-14	-16 1-14	-16 1-14	27.0
A1F-191919	-19 1.3/16-12	-19 1.3/16-12	-19 1.3/16-12	31.2
A1F-232323	-23 1.7/16-12	-23 1.7/16-12	-23 1.7/16-12	36.5
A1F-272727	-27 1.11/16-12	-27 1.11/16-12	-27 1.11/16-12	41.3
A1F-323232	-32 2-12	-32 2-12	-32 2-12	65.0

A1F6F

ORFS Male x Bulkhead Run Tee

SAE Specification

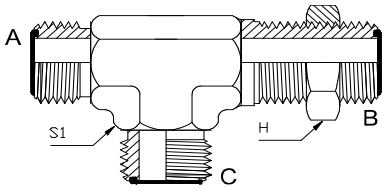

Item No	A-ORFS	B-ORFS	C-ORFS	S1	H
A1F6F-09	-09 9/16-18	-09 9/16-18	-09 9/16-18	14.3	20.6
A1F6F-11	-11 11/16-16	-11 11/16-16	-11 11/16-16	19.1	25.4
A1F6F-13	-13 13/16-16	-13 13/16-16	-13 13/16-16	22.2	31.8
A1F6F-16	-16 1-14	-16 1-14	-16 1-14	27.0	33.3
A1F6F-19	-19 1.3/16-12	-19 1.3/16-12	-19 1.3/16-12	31.2	38.1
A1F6F-23	-23 1.7/16-12	-23 1.7/16-12	-23 1.7/16-12	36.5	44.5

A1FF6

ORFS Male x Bulkhead Branch Tee

SAE Specification

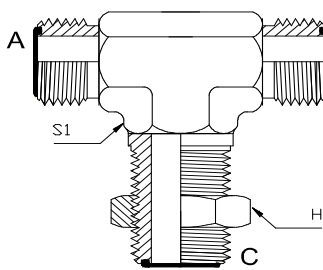

Item No	A-ORFS	B-ORFS	C-ORFS	S1	H
A1FF6-09	-09 9/16-18	-09 9/16-18	-09 9/16-18	14.3	20.6
A1FF6-11	-11 11/16-16	-11 11/16-16	-11 11/16-16	19.1	25.4
A1FF6-13	-13 13/16-16	-13 13/16-16	-13 13/16-16	22.2	31.8
A1FF6-16	-16 1-14	-16 1-14	-16 1-14	27.0	33.3
A1FF6-19	-19 1.3/16-12	-19 1.3/16-12	-19 1.3/16-12	31.2	38.1
A1FF6-23	-23 1.7/16-12	-23 1.7/16-12	-23 1.7/16-12	36.5	44.5

A1FFG

ORFS Male x BSPP Male Branch Tee

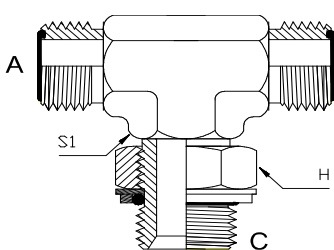

Item No	A-ORFS	B-ORFS	C-BSPP	S1	H
A1FFG-111106	-11 11/16-16	-11 11/16-16	-06 3/8-19	19.1	22
A1FFG-131308	-13 13/16-16	-13 3/4-16	-08 1/2-14	22.2	24
A1FFG-161608	-16 1-14	-16 1-14	-08 1/2-14	27.0	27
A1FFG-191912	-19 1.3/16-12	-19 1.3/16-12	-12 3/4-14	31.2	32

A1FFO
ORFS Male Tee x UNO Male Branch Tee

SAE Specification

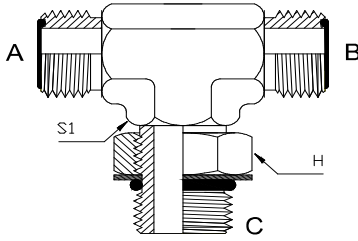

Item No	A-ORFS	B-ORFS	C-UNO	S1	H
A1FFO-090907	-09 9/16-18	-09 9/16-18	-07 7/16-20	14.3	17
A1FFO-111109	-11 11/16-16	-11 11/16-16	-09 9/16-18	19.1	19
A1FFO-131312	-13 13/16-16	-13 3/4-16	-12 3/4-16	22.2	24
A1FFO-161614	-16 1-14	-16 1-14	-14 7/8-14	27.0	27
A1FFO-191917	-19 1.3/16-12	-19 1.3/16-12	-17 1.1/16-12	31.2	32
A1FFO-232321	-23 1.7/16-12	-23 1.7/16-12	-21 1.5/16-12	36.5	41
A1FFO-272726	-27 1.11/16-12	-27 1.11/16-12	-26 1.5/8-12	41.3	50

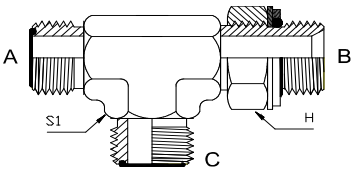
A1FGF
ORFS Male x BSPP Male Run Tee

Item No	A-ORFS	B-BSPP	C-ORFS	S1	H
A1FGF-090409	-09 9/16-18	-04 1/4-19	-09 9/16-18	14.3	19
A1FGF-110611	-11 11/16-16	-06 3/8-19	-11 11/16-16	19.1	22
A1FGF-130813	-13 13/16-16	-08 1/2-14	-13 13/16-16	22.2	27
A1FGF-160816	-16 1-14	-08 1/2-14	-16 1-14	27.0	27
A1FGF-191219	-19 1.3/16-12	-12 3/4-14	-19 1.3/16-12	31.2	32
A1FGF-231623	-23 1.7/16-12	-16 1-11	-23 1.7/16-12	36.5	41

A1FOF
ORFS Male x UNO Male Run Tee

SAE Specification

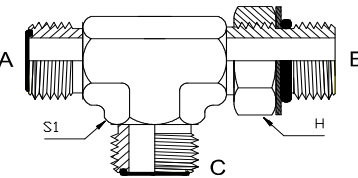

Item No	A-ORFS	B-UNO	C-ORFS	S1	H
A1FOF-090709	-09 9/16-18	-07 9/16-18	-09 9/16-18	14.3	15.9
A1FOF-110911	-11 11/16-16	-09 9/16-18	-11 11/16-16	19.1	19.1
A1FOF-131213	-13 13/16-16	-12 3/4-16	-13 13/16-16	22.2	23.8
A1FOF-161416	-16 1-14	-14 7/8-14	-16 1-14	27.0	27.0
A1FOF-191719	-19 1.1/16-12	-17 1.6/16-12	-19 1.3/16-12	31.2	34.9
A1FOF-232123	-23 1.7/16-12	-21 1.5/16-12	-23 1.7/16-12	36.5	41.3
A1FOF-272627	-27 1.11/16-12	-26 1.5/8-12	-27 1.11/16-12	41.3	47.6

A1J
JIC Male Tee

SAE Specification

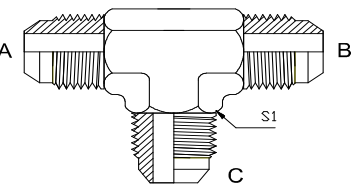

Item No	A-JIC	B-JIC	C-JIC	S1
A1J-070707	-07 7/16-20	-07 7/16-20	-07 7/16-20	11.1
A1J-080808	-08 1/2-20	-08 1/2-20	-08 1/2-20	14.3
A1J-090909	-09 9/16-18	-09 9/16-18	-09 9/16-18	14.3
A1J-090912	-09 9/16-18	-09 9/16-18	-12 3/4-16	19.1
A1J-121209	-12 3/4-16	-12 3/4-16	-09 9/16-18	19.1
A1J-121212	-12 3/4-16	-12 3/4-16	-12 3/4-16	19.1
A1J-121214	-12 3/4-16	-12 3/4-16	-14 7/8-14	22.2
A1J-121217	-12 3/4-16	-12 3/4-16	-17 1.1/16-12	27.0
A1J-141412	-14 7/8-14	-14 7/8-14	-12 3/4-16	22.2
A1J-141414	-14 7/8-14	-14 7/8-14	-14 7/8-14	22.2
A1J-141417	-14 7/8-14	-14 7/8-14	-17 1.1/16-12	27.0
A1J-171712	-17 1.1/16-12	-17 1.1/16-12	-12 3/4-16	27.0
A1J-171714	-17 1.1/16-12	-17 1.1/16-12	-14 7/8-14	27.0
A1J-171717	-17 1.1/16-12	-17 1.1/16-12	-17 1.1/16-12	27.0
A1J-171721	-17 1.1/16-12	-17 1.1/16-12	-21 1.5/16-12	33.3
A1J-171726	-17 1.1/16-12	-17 1.1/16-12	-26 1.5/8-12	41.3
A1J-172117	-17 1.1/16-12	-21 1.5/16-12	-17 1.1/16-12	33.3
A1J-212117	-21 1.5/16-12	-21 1.5/16-12	-17 1.1/16-12	33.3
A1J-212121	-21 1.5/16-12	-21 1.5/16-12	-21 1.5/16-12	33.3
A1J-262626	-26 1.5/8-12	-26 1.5/8-12	-26 1.5/8-12	41.3
A1J-303030	-30 1.7/8-12	-30 1.7/8-12	-30 1.7/8-12	47.6
A1J-404040	-40 2.1/2-12	-40 2.1/2-12	-40 2.1/2-12	63.5

A1J6J
JIC Male x Bulkhead Run Tee

SAE Specification

	Item No	A-JIC	B-JIC	C-JIC	S1	H
	A1J6J-07	-07 7/16-20	-07 7/16-20	-07 7/16-20	11.1	17.5
	A1J6J-08	-08 1/2-20	-08 1/2-20	-08 1/2-20	14.3	19.1
	A1J6J-09	-09 9/16-18	-09 9/16-18	-09 9/16-18	14.3	20.6
	A1J6J-12	-12 3/4-16	-12 3/4-16	-12 3/4-16	19.1	25.4
	A1J6J-14	-14 7/8-14	-14 7/8-14	-14 7/8-14	22.2	28.6
	A1J6J-17	-17 1.1/16-12	-17 1.1/16-12	-17 1.1/16-12	27.0	34.9
	A1J6J-21	-21 1.5/16-12	-21 1.5/16-12	-21 1.5/16-12	33.3	41.3
	A1J6J-26	-26 1.5/8-12	-26 1.5/8-12	-26 1.5/8-12	41.3	47.6

A1JGJ
JIC Male x BSPP Male Run Tee

	Item No	A-JIC	B-BSPP	C-JIC	S1	H
	A1JGJ-070207	-07 7/16-20	-02 1/8-28	-07 7/16-20	11	14
	A1JGJ-070407	-07 7/16-20	-04 1/4-19	-07 7/16-20	14	19
	A1JGJ-080208	-08 1/2-20	-02 1/8-28	-08 1/2-20	14	14
	A1JGJ-090409	-09 9/16-18	-04 1/4-19	-09 9/16-18	14	19
	A1JGJ-090609	-09 9/16-18	-06 3/8-19	-09 9/16-18	16	22
	A1JGJ-120412	-12 3/4-16	-04 1/4-19	-12 3/4-16	19	19
	A1JGJ-120612	-12 3/4-16	-06 3/8-19	-12 3/4-16	19	22
	A1JGJ-120812	-12 3/4-16	-08 1/2-14	-12 3/4-16	22	27
	A1JGJ-121212	-12 3/4-16	-12 3/4-14	-12 3/4-16	27	32
	A1JGJ-140814	-14 7/8-14	-08 1/2-14	-14 7/8-14	22	27
	A1JGJ-170817	-17 1.1/16-12	-08 1/2-14	-17 1.1/16-12	27	27
	A1JGJ-171217	-17 1.1/16-12	-12 3/4-14	-17 1.1/16-12	27	32
	A1JGJ-211621	-21 1.5/16-12	-16 1-11	-21 1.5/16-12	33	41
	A1JGJ-262026	-26 1.5/8-12	-20 1.1/4-11	-26 1.5/8-12	41	50

A1JJ6
JIC Male x Bulkhead Branch Tee

SAE Specification

	Item No	A-JIC	B-JIC	C-JIC	S1	H
	A1JJ6-07	-07 7/16-20	-07 7/16-20	-07 7/16-20	11.1	17.5
	A1JJ6-08	-08 1/2-20	-08 1/2-20	-08 1/2-20	14.3	19.1
	A1JJ6-09	-09 9/16-18	-09 9/16-18	-09 9/16-18	14.3	20.6
	A1JJ6-12	-12 3/4-16	-12 3/4-16	-12 3/4-16	19.1	25.4
	A1JJ6-14	-14 7/8-14	-14 7/8-14	-14 7/8-14	22.2	28.6
	A1JJ6-17	-17 1.1/16-12	-17 1.1/16-12	-17 1.1/16-12	27.0	34.9
	A1JJ6-21	-21 1.5/16-12	-21 1.5/16-12	-21 1.5/16-12	33.3	41.3
	A1JJ6-26	-26 1.5/8-12	-26 1.5/8-12	-26 1.5/8-12	41.3	47.6

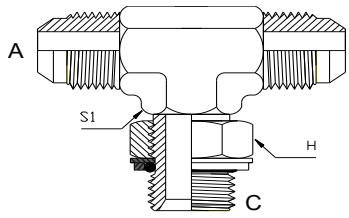
A1JJG
JIC Male x BSPP Male Branch Tee

Item No	A-JIC	B-JIC	C-BSPP	S1	H
A1JJG-070702	-07 7/16-20	-07 7/16-20	-02 1/8-28	11	14
A1JJG-070704	-07 7/16-20	-07 7/16-20	-04 1/4-19	14	19
A1JJG-090904	-09 9/16-18	-09 9/16-18	-04 1/4-19	14	19
A1JJG-090906	-09 9/16-18	-09 9/16-18	-06 3/8-19	16	22
A1JJG-121206	-12 3/4-16	-12 3/4-16	-06 3/8-19	19	22
A1JJG-121208	-12 3/4-16	-12 3/4-16	-08 1/2-14	22	27
A1JJG-141408	-14 7/8-14	-14 7/8-14	-08 1/2-14	22	27
A1JJG-141412	-14 7/8-14	-14 7/8-14	-12 3/4-14	27	32
A1JJG-171712	-17 1.1/16-12	-17 1.1/16-12	-12 3/4-14	27	32
A1JJG-212112	-21 1.5/16-12	-21 1.5/16-12	-12 3/4-14	33	32
A1JJG-212116	-21 1.5/16-12	-21 1.5/16-12	-16 1-11	33	41
A1JJG-262620	-26 1.5/8-12	-26 1.5/8-12	-20 1.1/4-11	41	50
A1JJG-303024	-30 1.7/8-12	-30 1.7/8-12	-24 1.1/2-11	48	55

A1JJN
JIC Male x NPT Male Branch Tee

SAE Specification

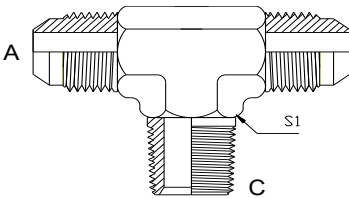

Item No	A-JIC	B-JIC	C-NPT	S1
A1JJN-070702	-07 7/16-20	-07 7/16-20	-02 1/8-27	11.1
A1JJN-070704	-07 7/16-20	-07 7/16-20	-04 1/4-18	14.3
A1JJN-090904	-09 9/16-18	-09 9/16-18	-04 1/4-18	14.3
A1JJN-090906	-09 9/16-18	-09 9/16-18	-06 3/8-18	19.1
A1JJN-090908	-09 9/16-18	-09 9/16-18	-08 1/2-18	19.1
A1JJN-121206	-12 3/4-16	-12 3/4-16	-06 3/8-18	19.1
A1JJN-121208	-12 3/4-16	-12 3/4-16	-08 1/2-18	22.2
A1JJN-141408	-14 7/8-14	-14 7/8-14	-08 1/2-14	22.2
A1JJN-171712	-17 1.1/16-12	-17 1.1/16-12	-12 3/4-14	27.0
A1JJN-212116	-21 1.5/16-12	-21 1.5/16-12	-16 1-11.5	33.3

A1JJO
JIC Male x UNO Male Branch Tee

SAE Specification

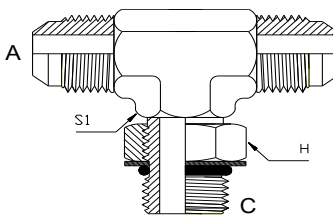

Item No	A-JIC	B-JIC	C-UNO	S1	H
A1JJO-070707	-07 7/16-20	-07 7/16-20	-07 7/16-20	11.1	14.3
A1JJO-070709	-07 7/16-20	-07 7/16-20	-09 9/16-18	14.3	17.5
A1JJO-090907	-09 9/16-18	-09 9/16-18	-07 7/16-20	14.3	14.3
A1JJO-090909	-09 9/16-18	-09 9/16-18	-09 9/16-18	14.3	17.5
A1JJO-090912	-09 9/16-18	-09 9/16-18	-12 3/4-16	19.1	22.2
A1JJO-121209	-12 3/4-16	-12 3/4-16	-09 9/16-18	19.1	17.5
A1JJO-121212	-12 3/4-16	-12 3/4-16	-12 3/4-16	19.1	22.2
A1JJO-121214	-12 3/4-16	-12 3/4-16	-14 7/8-14	22.2	25.4
A1JJO-141414	-14 7/8-14	-14 7/8-14	-14 7/8-14	22.2	25.4
A1JJO-171717	-17 1.1/16-12	-17 1.1/16-12	-17 1.1/16-12	27.0	31.8
A1JJO-212121	-21 1.5/16-12	-21 1.5/16-12	-21 1.5/16-12	33.3	38.1
A1JJO-262626	-26 1.5/8-12	-26 1.5/8-12	-26 1.5/8-12	41.3	47.6

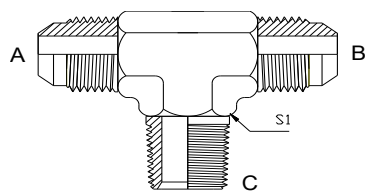
A1JJT
JIC Male x BSPT Male Branch Tee

Item No	A-JIC	B-JIC	C-BSPT	S1
A1JJT-070702	-07 7/16-20	-07 7/16-20	-02 1/8-28	11
A1JJT-070704	-07 7/16-20	-07 7/16-20	-04 1/4-19	14
A1JJT-070706	-07 7/16-20	-07 7/16-20	-06 3/8-19	19
A1JJT-080804	-08 1/2-20	-08 1/2-20	-04 1/4-19	14
A1JJT-090904	-09 9/16-18	-09 9/16-18	-04 1/4-19	14
A1JJT-090906	-09 9/16-18	-09 9/16-18	-06 3/8-19	19
A1JJT-090908	-09 9/16-18	-09 9/16-18	-08 1/2-14	22
A1JJT-121204	-12 3/4-16	-12 3/4-16	-04 1/4-19	19
A1JJT-121206	-12 3/4-16	-12 3/4-16	-06 3/8-19	19
A1JJT-121208	-12 3/4-16	-12 3/4-16	-08 1/2-14	22
A1JJT-141406	-14 7/8-14	-14 7/8-14	-06 3/8-19	22
A1JJT-141408	-14 7/8-14	-14 7/8-14	-08 1/2-14	22
A1JJT-171712	-17 1.1/16-12	-17 1.1/16-12	-12 3/4-14	27
A1JJT-171716	-17 1.1/16-12	-17 1.1/16-12	-16 1-11	33
A1JJT-212116	-21 1.5/16-12	-21 1.5/16-12	-16 1-11	33
A1JJT-262620	-26 1.5/8-12	-26 1.5/8-12	-20 1.1/4-11	41

A1JNJ
JIC Male x NPT Male Run Tee

SAE Specification

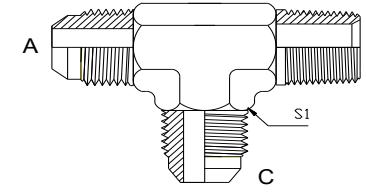

Item No	A-JIC	B-NPT	C-JIC	S1
A1JNJ-070207	-07 7/16-20	-02 1/8-28	-07 7/16-20	11.1
A1JNJ-070407	-07 7/16-20	-04 1/4-18	-07 7/16-20	14.3
A1JNJ-090409	-09 9/16-18	-04 1/4-18	-09 9/16-18	14.3
A1JNJ-090609	-09 9/16-18	-06 3/8-18	-09 9/16-18	19.1
A1JNJ-120612	-12 3/4-16	-06 3/8-18	-12 3/4-16	19.1
A1JNJ-120812	-12 3/4-16	-08 1/2-14	-12 3/4-16	22.2
A1JNJ-140814	-14 7/8-14	-08 1/2-14	-14 7/8-14	22.2
A1JNJ-171217	-17 1.1/16-12	-12 3/4-11.5	-17 1.1/16-12	27.0
A1JNJ-211621	-21 1.5/16-12	-16 1-11.5	-21 1.5/16-12	33.3
A1JNJ-262026	-26 1.5/8-12	-20 1.1/4-11.5	-26 1.5/8-12	41.3

A1JOJ
JIC Male x UNO Male Run Tee

SAE Specification

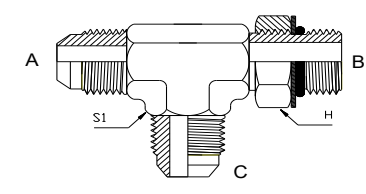

Item No	A-JIC	B-UNO	C-JIC	S1	H
A1JOJ-070707	-07 7/16-20	-07 7/16-20	-07 7/16-20	11.3	14.3
A1JOJ-070907	-07 7/16-20	-09 9/16-18	-07 7/16-20	14.3	17.5
A1JOJ-090909	-09 9/16-18	-09 9/16-18	-09 9/16-18	14.3	17.5
A1JOJ-091209	-09 9/16-18	-12 3/4-16	-09 9/16-18	19.1	22.2
A1JOJ-120912	-12 3/4-16	-09 9/16-18	-12 3/4-16	19.1	17.5
A1JOJ-121212	-12 3/4-16	-12 3/4-16	-12 3/4-16	19.1	22.2
A1JOJ-121412	-12 3/4-16	-14 7/8-14	-12 3/4-16	22.2	25.4
A1JOJ-141412	-14 7/8-14	-14 7/8-14	-12 3/4-16	22.2	25.4
A1JOJ-141414	-14 7/8-14	-14 7/8-14	-14 7/8-14	22.2	25.4
A1JOJ-171417	-17 1.1/16-12	-14 7/8-14	-17 1.1/16-12	27.0	25.4
A1JOJ-171717	-17 1.1/16-12	-17 1.1/16-12	-17 1.1/16-12	27.0	31.8
A1JOJ-212121	-21 1.5/16-12	-21 1.5/16-12	-21 1.5/16-12	33.3	38.1
A1JOJ-262626	-26 1.5/8-12	-26 1.5/8-12	-26 1.5/8-12	41.3	47.6
A1JOJ-303030	-30 1.7/8-12	-30 1.7/8-12	-30 1.7/8-12	47.6	54.0

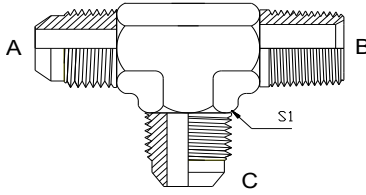
A1JTJ
JIC Male x BSPT Male Run Tee

Item No	A-JIC	B-BSPT	C-JIC	S1
A1JTJ-070207	-07 7/16-20	-02 1/8-28	-07 7/16-20	11
A1JTJ-070407	-07 7/16-20	-04 1/4-19	-07 7/16-20	14
A1JTJ-070607	-07 7/16-20	-06 3/8-19	-07 7/16-20	19
A1JTJ-090409	-09 9/16-18	-04 1/4-19	-09 9/16-18	14
A1JTJ-090609	-09 9/16-18	-06 3/8-19	-09 9/16-18	19
A1JTJ-120612	-12 3/4-16	-06 3/8-19	-12 3/4-16	19
A1JTJ-120812	-12 3/4-16	-08 1/2-14	-12 3/4-16	22
A1JTJ-140814	-14 7/8-14	-08 1/2-14	-14 7/8-14	22
A1JTJ-171217	-17 1.1/16-12	-12 3/4-14	-17 1.1/16-12	27
A1JTJ-211621	-21 1.5/16-12	-16 1-11	-21 1.5/16-12	33

A1N
NPT Male Tee

SAE Specification

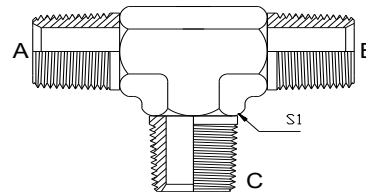

Item No	A-NPT	B-NPT	C-NPT	S1
A1N-020202	-02 1/8-27	-02 1/8-27	-02 1/8-27	11.1
A1N-040404	-04 1/4-18	-04 1/4-18	-04 1/4-18	14.3
A1N-060606	-06 3/8-18	-06 3/8-18	-06 3/8-18	19.1
A1N-080808	-08 1/2-14	-08 1/2-14	-08 1/2-14	22.2
A1N-121212	-12 3/4-14	-12 3/4-14	-12 3/4-14	27.0
A1N-161616	-16 1-11.5	-16 1-11.5	-16 1-11.5	33.3
A1N-202020	-20 1.1/4-11.5	-20 1.1/4-11.5	-20 1.1/4-11.5	41.3

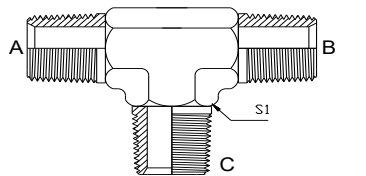
A1T
BSPT Male Tee

Item No	A-BSPT	B-BSPT	C-BSPT	S1
A1T-020202	-02 1/8-28	-02 1/8-28	-02 1/8-28	11
A1T-040404	-04 1/4-19	-04 1/4-19	-04 1/4-19	14
A1T-060606	-06 3/8-19	-06 3/8-19	-06 3/8-19	16
A1T-060608	-06 3/8-19	-06 3/8-19	-08 1/2-14	22
A1T-080808	-08 1/2-14	-08 1/2-14	-08 1/2-14	22
A1T-080812	-08 1/2-14	-08 1/2-14	-12 3/4-14	27
A1T-121208	-12 3/4-14	-12 3/4-14	-08 1/2-14	27
A1T-121212	-12 3/4-14	-12 3/4-14	-12 3/4-14	27
A1T-161616	-16 1-11	-16 1-11	-16 1-11	33
A1T-202020	-20 1.1/4-11	-20 1.1/4-11	-20 1.1/4-11	41
A1T-242424	-24 1.1/2-11	-24 1.1/2-11	-24 1.1/2-11	48
A1T-323232	-32 2-11	-32 2-11	-32 2-11	64

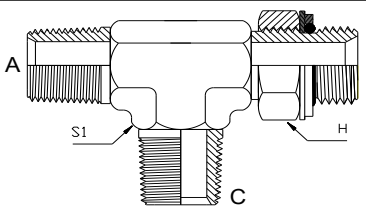
A1TGT
BSPT Male x BSPP Male Run Tee

Item No	A-BSPT	B-BSPP	C-BSPT	S1	H
A1TGT-040404	-04 1/4-19	-04 1/4-19	-04 1/4-19	14	19
A1TGT-060606	-06 3/8-19	-06 3/8-19	-06 3/8-19	19	22
A1TGT-080808	-08 1/2-14	-08 1/2-14	-08 1/2-14	22	27
A1TGT-121212	-12 3/4-14	-12 3/4-14	-12 3/4-14	27	32
A1TGT-161616	-16 1-11	-16 1-11	-16 1-11	33	41

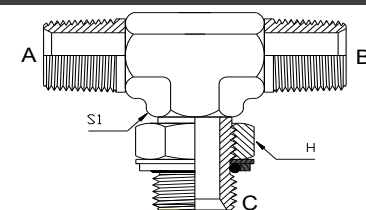
A1TTG
BSPT Male x BSPP Male Branch Tee

Item No	A-BSPT	B-BSPT	C-BSPP	S1	H
A1TTG-040404	-04 1/4-19	-04 1/4-19	-04 1/4-19	14	19
A1TTG-060606	-06 3/8-19	-06 3/8-19	-06 3/8-19	19	22

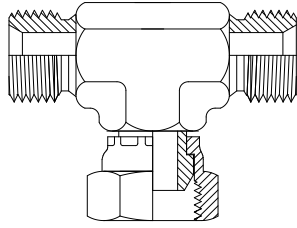
A2B
BSPP Male x BSPP Female Branch Tee

Item No	A-BSPP	B-BSPP	C-BSPP	S1	H
A2B-040404	-04 1/4-19	-04 1/4-19	-04 1/4-19	14	19
A2B-060606	-06 3/8-19	-06 3/8-19	-06 3/8-19	16	22
A2B-080808	-08 1/2-14	-08 1/2-14	-08 1/2-14	22	27
A2B-121212	-12 3/4-14	-12 3/4-14	-12 3/4-14	27	32

A2F
ORFS Male x ORFS Female Branch Tee

SAE Specification

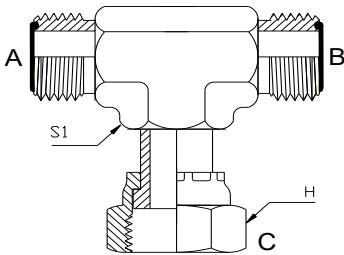

Item No	A-ORFS	B-ORFS	C-ORFS	S1	H
A2F-090909	-09 9/16-18	-09 9/16-18	-09 9/16-18	14.3	17.5
A2F-111111	-11 11/16-16	-11 11/16-16	-11 11/16-16	20.6	20.6
A2F-131313	-13 13/16-16	-13 13/16-16	-13 13/16-16	23.8	23.8
A2F-161616	-16 1-14	-16 1-14	-16 1-14	28.6	28.6
A2F-191919	-19 1.3/16-12	-19 1.3/16-12	-19 1.3/16-12	31.2	34.9
A2F-232323	-23 1.7/16-12	-23 1.7/16-12	-23 1.7/16-12	36.5	41.3
A2F-272727	-27 1.11/16-12	-27 1.11/16-12	-27 1.11/16-12	41.3	47.6
A2F-323232	-32 2-12	-32 2-12	-32 2-12	47.6	57.2

A2J
JIC Male x JIC Female Branch Tee

SAE Specification

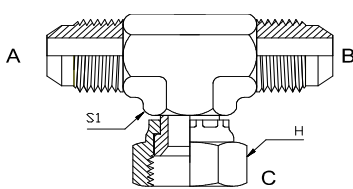

Item No	A-JIC	B-JIC	C-JIC	S1	H
A2J-070707	-07 7/16-20	-07 7/16-20	-07 7/16-20	11.1	14.3
A2J-080808	-08 1/2-20	-08 1/2-20	-08 1/2-20	14.3	15.9
A2J-090909	-09 9/16-18	-09 9/16-18	-09 9/16-18	14.3	17.5
A2J-121212	-12 3/4-16	-12 3/4-16	-12 3/4-16	19.1	22.2
A2J-141414	-14 7/8-14	-14 7/8-14	-14 7/8-14	22.2	25.4
A2J-171717	-17 1.1/16-12	-17 1.1/16-12	-17 1.1/16-12	27.0	31.8
A2J-212121	-21 1.5/16-12	-21 1.5/16-12	-21 1.5/16-12	33.3	38.1
A2J-262626	-26 1.5/8-12	-26 1.5/8-12	-26 1.5/8-12	41.3	50.8
A2J-303030	-30 1.7/8-12	-30 1.7/8-12	-30 1.7/8-12	47.6	57.2
A2J-404040	-40 2.1/2-12	-40 2.1/2-12	-40 2.1/2-12	63.5	76.2

A2J2
JIC Female x JIC Female x JIC Male Tee

SAE Specification

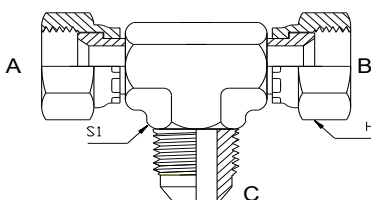

Item No	A-JIC	B-JIC	C-JIC	S1	H
A2J-070707	-07 7/16-20	-07 7/16-20	-07 7/16-20	11.1	14.3
A2J-090909	-09 9/16-18	-09 9/16-18	-09 9/16-18	14.3	17.5
A2J-121212	-12 3/4-16	-12 3/4-16	-12 3/4-16	19.1	22.2
A2J-141414	-14 7/8-14	-14 7/8-14	-14 7/8-14	22.2	25.4
A2J-171717	-17 1.1/16-12	-17 1.1/16-12	-17 1.1/16-12	27.0	31.8
A2J-212121	-21 1.5/16-12	-21 1.5/16-12	-21 1.5/16-12	33.3	38.1

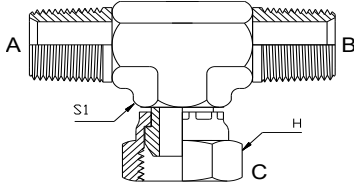
A2T
BSPT Male x BSPP Female Branch Tee

Item No	A-BSPT	B-BSPT	C-BSPP	S1	H
A2T-020202	-02 1/8-28	-02 1/8-28	-02 1/8-28	11	14
A2T-040404	-04 1/4-19	-04 1/4-19	-04 1/4-19	14	19
A2T-060606	-06 3/8-19	-06 3/8-19	-06 3/8-19	16	22
A2T-080808	-08 1/2-14	-08 1/2-14	-08 1/2-14	22	27
A2T-121212	-12 3/4-14	-12 3/4-14	-12 3/4-14	27	32
A2T-161616	-16 1-11	-16 1-11	-16 1-11	33	41 *

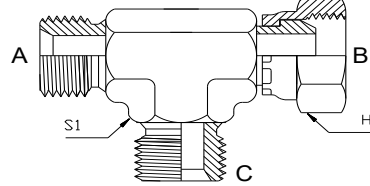
A3B
BSPP Male x BSPP Female Run Tee

Item No	A-BSPP	B-BSPP	C-BSPP	S1	H
A3B-040404	-04 1/4-19	-04 1/4-19	-04 1/4-19	14	19
A3B-060606	-06 3/8-19	-06 3/8-19	-06 3/8-19	16	22
A3B-080808	-08 1/2-14	-08 1/2-14	-08 1/2-14	22	27

A3F
ORFS Male x ORFS Female Run Tee

SAE Specification

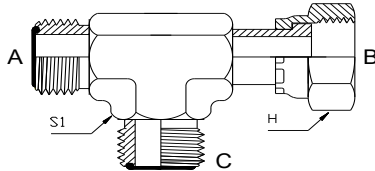

Item No	A-ORFS	B-ORFS	C-ORFS	S1	H
A3F-090909	-09 9/16-18	-09 9/16-18	-09 9/16-18	14.3	17.5
A3F-111111	-11 11/16-16	-11 11/16-16	-11 11/16-16	20.6	20.6
A3F-131313	-13 13/16-16	-13 13/16-16	-13 13/16-16	23.8	23.8
A3F-161616	-16 1-14	-16 1-14	-16 1-14	28.6	28.6
A3F-191919	-19 1.3/16-12	-19 1.3/16-12	-19 1.3/16-12	31.2	34.9
A3F-232323	-23 1.7/16-12	-23 1.7/16-12	-23 1.7/16-12	36.5	41.3
A3F-272727	-27 1.11/16-12	-27 1.11/16-12	-27 1.11/16-12	41.3	47.6
A3F-323232	-32 2-12	-32 2-12	-32 2-12	47.6	57.2

A3J
JIC Male x JIC Female Run Tee

SAE Specification

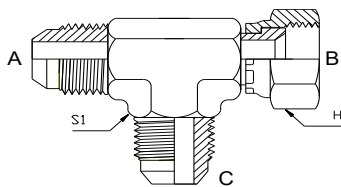

Item No	A-JIC	B-JIC	C-JIC	S1	H
A3J-070707	-07 7/16-20	-07 7/16-20	-07 7/16-20	11.1	14.3
A3J-080808	-08 1/2-20	-08 1/2-20	-08 1/2-20	14.3	15.9
A3J-090909	-09 9/16-18	-09 9/16-18	-09 9/16-18	14.3	17.5
A3J-121209	-12 3/4-16	-12 3/4-16	-09 9/16-18	19.1	22.2
A3J-121212	-12 3/4-16	-12 3/4-16	-12 3/4-16	19.1	22.2
A3J-141412	-14 7/8-14	-14 7/8-14	-12 3/4-16	22.2	25.4
A3J-141414	-14 7/8-14	-14 7/8-14	-14 7/8-14	22.2	25.4
A3J-141714	-14 7/8-14	-17 1.1/16-12	-14 7/8-14	27.0	31.8
A3J-171714	-17 1.1/16-12	-17 1.1/16-12	-14 7/8-14	27.0	31.8
A3J-171717	-17 1.1/16-12	-17 1.1/16-12	-17 1.1/16-12	27.0	31.8
A3J-212117	-21 1.5/16-12	-21 1.5/16-12	-17 1.1/16-12	33.3	38.1
A3J-212121	-21 1.5/16-12	-21 1.5/16-12	-21 1.5/16-12	33.3	38.1
A3J-262626	-26 1.5/8-12	-26 1.5/8-12	-26 1.5/8-12	41.3	50.8
A3J-303030	-30 1.7/8-12	-30 1.7/8-12	-30 1.7/8-12	47.6	57.2
A3J-404040	-40 2.1/2-12	-40 2.1/2-12	-40 2.1/2-12	63.5	76.2

A3T
BSPT Male x BSPP Female Run Tee

Item No	A-BSPT	B-BSPP	C-BSPT	S1	H
A3T-020202	-02 1/8-28	-02 1/8-28	-02 1/8-28	11	14
A3T-040404	-04 1/4-19	-04 1/4-19	-04 1/4-19	14	19
A3T-060606	-06 3/8-19	-06 3/8-19	-06 3/8-19	16	22
A3T-080808	-08 1/2-14	-08 1/2-14	-08 1/2-14	22	27
A3T-121212	-12 3/4-14	-12 3/4-14	-12 3/4-14	27	32
A3T-161616	-16 1-11	-16 1-11	-16 1-11	33	41 *
A3T-202020	-20 1.1/4-11	-20 1.1/4-11	-20 1.1/4-11	41	50 *
A3T-242424	-24 1.1/2-11	-24 1.1/2-11	-24 1.1/2-11	50	55 *

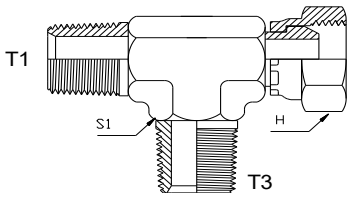
A3TB
BSPP Female x BSPT Male Branch Tee

Item No	A-JIC	B-JIC	C-ORFS	S1	H
A3TB-040404	-04 1/4-19	-04 1/4-19	-04 1/4-19	14	19
A3TB-060606	-06 3/8-19	-06 3/8-19	-06 3/8-19	16	22
A3TB-080808	-08 1/2-14	-08 1/2-14	-08 1/2-14	22	27
A3TB-121212	-12 3/4-14	-12 3/4-14	-12 3/4-14	27	32
A3TB-161616	-16 1-11	-16 1-11	-16 1-11	33	41 *

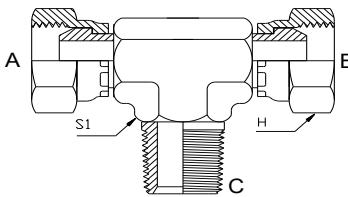

A4B
BSPP Female Three Way Tee

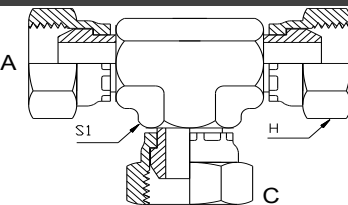
Item No	A-BSPP	B-BSPP	C-BSPP	S1	H
A4B-040404	-04 1/4-19	-04 1/4-19	-04 1/4-19	14	19
A4B-080808	-08 1/2-14	-08 1/2-14	-08 1/2-14	22	27

A4J
JIC Female Three Way Tee

SAE Specification

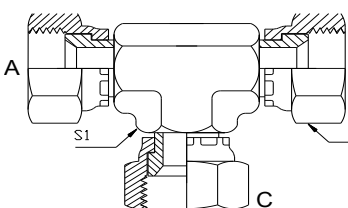
Item No	A-JIC	B-JIC	C-JIC	S1	H
A4J-070707	-07 7/16-20	-07 7/16-20	-07 7/16-20	11.1	14.3
A4J-090909	-09 9/16-18	-09 9/16-18	-09 9/16-18	14.3	17.5
A4J-121212	-12 3/4-16	-12 3/4-16	-12 3/4-16	19.1	22.2
A4J-141414	-14 7/8-14	-14 7/8-14	-14 7/8-14	22.2	25.4
A4J-171717	-17 1.1/16-12	-17 1.1/16-12	-17 1.1/16-12	27.0	31.8
A4J-212121	-21 1.5/16-12	-21 1.5/16-12	-21 1.5/16-12	33.3	38.1



A4U
NPSM Female Three Way Tee

SAE Specification

Item No	A-NPSM	B-NPSM	C-NPSM	S1	H
A4U-040404	-04 1/4-18	-04 1/4-18	-04 1/4-18	14.3	19.1
A4U-080808	-08 1/2-14	-08 1/2-14	-08 1/2-14	22.2	25.4

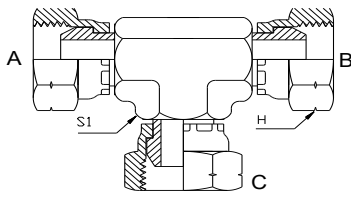

A5JJT
JIC Male x BSPT Female Branch Tee

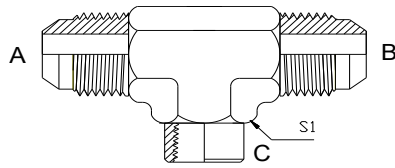
Item No	A-JIC	B-JIC	C-BSPT	S1
A5JJT-121204	-12 3/4-16	-12 3/4-16	-04 1/4-19	19

A5N
NPT Female x NPT Male Run Tee

SAE Specification

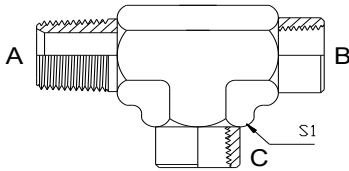
Item No	A-NPT	B-NPT	C-NT	S1
A5N-020202	-02 1/8-27	-02 1/8-27	-02 1/8-27	14.3
A5N-040404	-04 1/4-18	-04 1/4-18	-04 1/4-18	19.1
A5N-060606	-06 3/8-18	-06 3/8-18	-06 3/8-18	22.2
A5N-080808	-08 1/2-14	-08 1/2-14	-08 1/2-14	27.0
A5N-121212	-12 3/4-14	-12 3/4-14	-12 3/4-14	33.3
A5N-161616	-16 1-11.5	-16 1-11.5	-16 1-11.5	41.3
A5N-202020	-20 1.1/4-11.5	-20 1.1/4-11.5	-20 1.1/4-11.5	47.6
A5N-242424	-24 1.1/2-11.5	-24 1.1/2-11.5	-24 1.1/2-11.5	65.0

A5O
UNO Female x UNO Male Run Tee

SAE Specification

Item No	A-UNO	B-UNO	C-UNO	S1	H
A5O-070707	-07 7/16-20	-07 7/16-20	-07 7/16-20	11.1	14.3
A5O-090909	-09 9/16-18	-09 9/16-18	-09 9/16-18	14.3	17.5

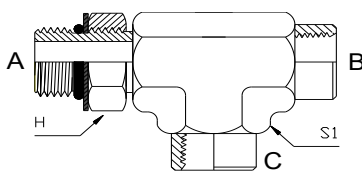

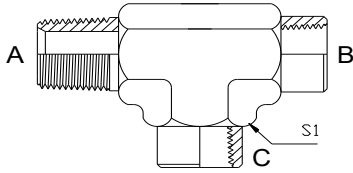
A5T
BSPT Female x BSPT Male Run Tee

Item No	A-BSPT	B-BSPT	C-BSPT	S1
A5T-020202	-02 1/8-28	-02 1/8-28	-02 1/8-28	16
A5T-040404	-04 1/4-19	-04 1/4-19	-04 1/4-19	19
A5T-060606	-06 3/8-19	-06 3/8-19	-06 3/8-19	24
A5T-080808	-08 1/2-14	-08 1/2-14	-08 1/2-14	27
A5T-121212	-12 3/4-14	-12 3/4-14	-12 3/4-14	33
A5T-161616	-16 1-11	-16 1-11	-16 1-11	41

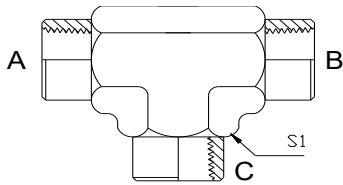
A7B
BSPP Female Tee

Item No	A-BSPP	B-BSPP	C-BSPP	S1
A7B-040404	-04 1/4-19	-04 1/4-19	-04 1/4-19	19
A7B-060606	-06 3/8-19	-06 3/8-19	-06 3/8-19	24
A7B-080808	-08 1/2-14	-08 1/2-14	-08 1/2-14	27
A7B-121212	-12 3/4-14	-12 3/4-14	-12 3/4-14	33
A7B-161616	-16 1-11	-16 1-11	-16 1-11	41
A7B-202020	-20 1.1/4-11	-20 1.1/4-11	-20 1.1/4-11	50
A7B-242424	-24 1.1.2-11	-24 1.1.2-11	-24 1.1.2-11	60
A7B-323232	-32 2-11	-32 2-11	-32 2-11	70

A7N
NPT Female Tee

SAE Specification

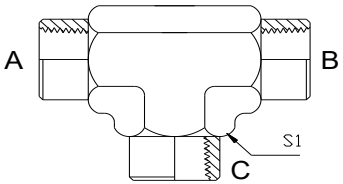

Item No	A-NPT	B-NPT	C-NPT	S1
A7N-020202	-02 1/8-27	-02 1/8-27	-02 1/8-27	14.3
A7N-040404	-04 1/4-18	-04 1/4-18	-04 1/4-18	19.1
A7N-060606	-06 3/8-18	-06 3/8-18	-06 3/8-18	22.2
A7N-080808	-08 1/2-14	-08 1/2-14	-08 1/2-14	27.0
A7N-121212	-12 3/4-14	-12 3/4-14	-12 3/4-14	33.3
A7N-161616	-16 1-11.5	-16 1-11.5	-16 1-11.5	41.3
A7N-202020	-20 1.1/4-11.5	-20 1.1/4-11.5	-20 1.1/4-11.5	47.6
A7N-242424	-24 1.1/2-11.5	-24 1.1/2-11.5	-24 1.1/2-11.5	65.0
A7N-323232	-32 2-11.5	-32 2-11.5	-32 2-11.5	71.0

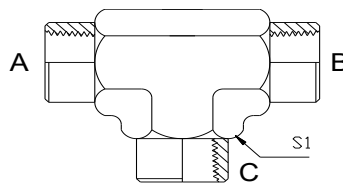
A7T
BSPT Female Tee

Item No	A-BSPT	B-BSPT	C-BSPT	S1
A7T-020202	-02 1/8-28	-02 1/8-28	-02 1/8-28	19
A7T-040404	-04 1/4-19	-04 1/4-19	-04 1/4-19	19
A7T-060606	-06 3/8-19	-06 3/8-19	-06 3/8-19	24
A7T-080808	-08 1/2-14	-08 1/2-14	-08 1/2-14	27
A7T-121212	-12 3/4-14	-12 3/4-14	-12 3/4-14	33
A7T-161616	-16 1-11	-16 1-11	-16 1-11	41
A7T-202020	-20 1.1/4-11	-20 1.1/4-11	-20 1.1/4-11	50
A7T-242424	-24 1.1.2-11	-24 1.1.2-11	-24 1.1.2-11	60
A7T-323232	-32 2-11	-32 2-11	-32 2-11	70

ZJ
JIC Male Cross

SAE Specification

	Item No	A-JIC		S1
	ZJ-07	-07 7/16-20	x 4	11.1
	ZJ-09	-09 9/16-18	x 4	14.3
	ZJ-12	-12 3/4-16	x 4	19.1
	ZJ-14	-14 7/8-14	x 4	22.2
	ZJ-17	-17 1.1/16-12	x 4	27.0
	ZJ-21	-21 1.5/16-12	x 4	33.3

ZN
NPT Female Cross

	Item No	A-NPT		S1
	ZN-04	-04 1/4-18	x 4	19
	ZN-06	-06 3/8-18	x 4	24
	ZN-08	-08 1/2-14	x 4	27
	ZN-12	-12 3/4-14	x 4	33
	ZN-16	-16 1-11.5	x 4	41
	ZN-20	-20 1.1/4-11.5	x 4	
	ZN-24	-24 1.1/2-11.5	x 4	

ZT
BSPT Female Cross

	Item No	A-BSPT		S1
	ZT-04	-04 1/4-19	x 4	19
	ZT-06	-06 3/8-19	x 4	24
	ZT-08	-08 1/2-14	x 4	27
	ZT-12	-12 3/4-14	x 4	33
	ZT-16	-16 1-11	x 4	41

8F
ORFS Bulkhead Nut

SAE Specification

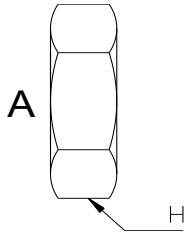

Item No	A-ORFS	H
8F-09	-09 9/16-18	20.6
8F-11	-11 11/16-16	25.4
8F-13	-13 13/16-16	31.8
8F-16	-16 1-14	33.3
8F-19	-19 1.3/16-12	38.1
8F-23	-23 1.7/16-12	44.5
8F-27	-27 1.11/16-12	60.3

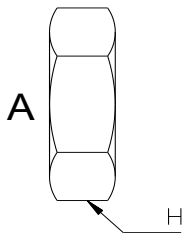
8G
BSPP Bulkhead Nut

Item No	A-BSPP	H
8G-02	-02 1/8-28	14
8G-04	-04 1/4-19	19
8G-06	-06 3/8-19	22
8G-08	-08 1/2-14	27
8G-12	-12 3/4-14	32
8G-16	-16 1-11	41
8G-20	-20 1.1/4-11	50
8G-24	-24 1.1/2-11	55
8G-32	-32 2-11	70

8J
JIC Bulkhead Nut

SAE Specification

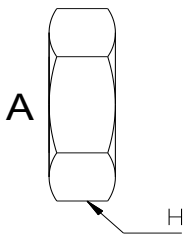

Item No	A-JIC	H
8J-07	-07 7/16-20	17.5
8J-08	-08 1/2-20	19.1
8J-09	-09 9/16-18	20.6
8J-12	-12 3/4-16	25.4
8J-14	-14 7/8-14	28.6
8J-17	-17 1.1/16-12	34.9
8J-19	-19 1.3/16-12	38.1
8J-21	-21 1.5/16-12	41.3
8J-26	-26 1.5/8-12	47.6
8J-30	-30 1.7/8-12	54.0
8J-40	-40 2.1/2-12	69.9

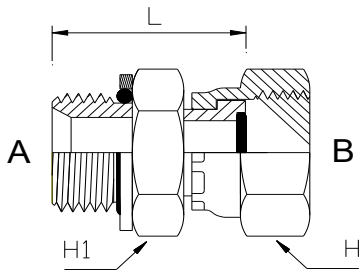
2GB*GSP
BSPP Male Pressure Gauge Adaptor

Item No	A-BSPP	B-GAUGE	L	H1	H
2GB-0204GSP	-04 1/8-28	1/4"	24	14	19
2GB-0404GSP	-04 1/4-19	1/4"	30	19	19
2GB-0408GSP	-04 1/4-19	1/2"	33	22	27
2GB-0604GSP	-06 3/8-19	1/4"	32	22	19
2GB-0608GSP	-06 3/8-19	1/2"	34	22	27
2GB-0808GSP	-08 1/2-14	1/2"	37	27	27

* Replacement O-Rings for Gauge adaptors OR-GSP

Page 117

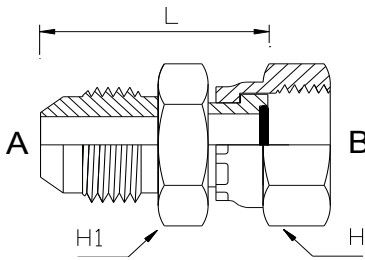
2JB*GSP
JIC Male Pressure Gauge Adaptor

Item No	A-JIC	B-GAUGE	L	H1	H
2JB-0704GSP	-07 7/16-20	1/4"	29	14	19
2JB-0904GSP	-09 9/16-18	1/4"	32	17	19
2JB-0908GSP	-09 9/16-18	1/2"	33	22	27
2JB-1204GSP	-12 3/4-16	1/4"	33	22	19
2JB-1208GSP	-12 3/4-16	1/2"	38	22	27

* Replacement O-Rings for Gauge adaptors OR-GSP

Page 117

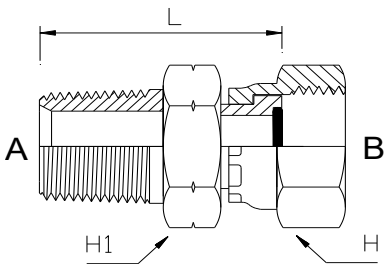
2NB*GSP
NPT Male Pressure Gauge Adaptor

Item No	A-NPT	B-GAUGE	L	H1	H
2NB-0404GSP	-04 1/4-18	1/4"	31	17	19

* Replacement O-Rings for Gauge adaptors OR-GSP

Page 117

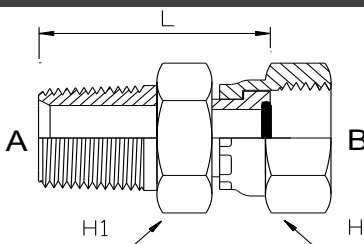
2TB*GSP
BSPT Male Pressure Gauge Adaptor

Item No	A-BSPT	B-GAUGE	L	H1	H
2TB-0204GSP	-02 1/8-28	1/4"	26	14	19
2TB-0404GSP	-04 1/4-19	1/4"	31	17	19
2TB-0608GSP	-06 3/8-19	1/2"	34	22	27

* Replacement O-Rings for Gauge adaptors OR-GSP

Page 117

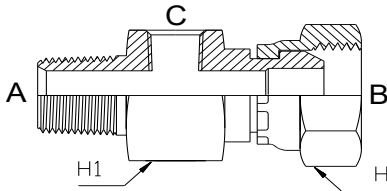
A9BG
BSPT (BSPP Port) Test Point Adaptor

Item No	A-BSPT	B-BSPP	C-BSPP	H1	H
A9BG-0402	-04 1/4-19	-04 1/4-19	-02 1/8-28	27	19
A9BG-0602	-06 3/8-19	-06 3/8-19	-02 1/8-28	27	22
A9BG-0802	-08 1/2-14	-08 1/2-14	-02 1/8-28	27	27
A9BG-1202	-12 3/4-14	-12 3/4-14	-02 1/8-28	32	32
A9BG-1602	-16 1-11	-16 1-11	-02 1/8-28	38	41 *

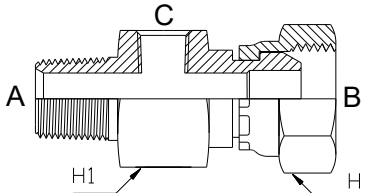
A9GG
BSPP (BSPP Port) Test Point Adaptor

Item No	A-BSPP	B-BSPP	C-BSPP	H1	H
A9BG-0402R	-04 1/4-19	-04 1/4-19	-02 1/8-28	27	19
A9BG-0602R	-06 3/8-19	-06 3/8-19	-02 1/8-28	27	22
A9BG-0802R	-08 1/2-14	-08 1/2-14	-02 1/8-28	27	27
A9BG-1202R	-12 3/4-14	-12 3/4-14	-02 1/8-28	32	32

* O-Ring + Retaining Ring type only

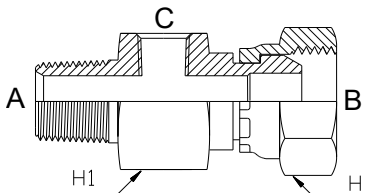
A9BT
BSPT (BSPT Port) Test Point Adaptor

Item No	A-BSPT	B-BSPP	C-BSPT	H1	H
A9BT-0402	-04 1/4-19	-04 1/4-19	-02 1/8-28	27	19
A9BT-0602	-06 3/8-19	-06 3/8-19	-02 1/8-28	27	22
A9BT-0802	-08 1/2-14	-08 1/2-14	-02 1/8-28	27	27
A9BT-1202	-12 3/4-14	-12 3/4-14	-02 1/8-28	32	32
A9BT-1602	-16 1-11	-16 1-11	-02 1/8-28	38	41 *

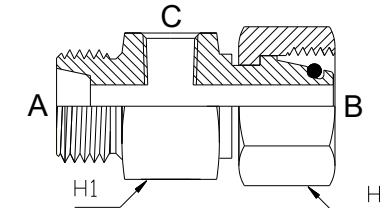
A9CG
DKL (BSPP Port) Test Point Adaptor

Item No	A-DKL	A-DKL	C-BSPP	H1	H
A9CG-1402	M14x1.5 (T08)	M14x1.5 (T08)	-02 1/8-28	27	17
A9CG-1802	M18x1.5 (T12)	M18x1.5 (T12)	-02 1/8-28	27	22
A9CG-2202	M22x1.5 (T15)	M22x1.5 (T15)	-02 1/8-28	27	27
A9CG-2602	M26x1.5 (T18)	M26x1.5 (T18)	-02 1/8-28	27	32

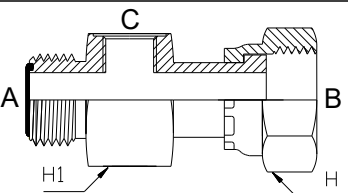
A9FG
ORFS (BSPP Port) Test Point Adaptor

Item No	A-ORFS	B-ORFS	C-BSPP	H1	H
A9FG-0902	-09 9/16-18	-09 9/16-18	-02 1/8-28	27	17.5
A9FG-1102	-11 11/16-16	-11 11/16-16	-02 1/8-28	27	20.6
A9FG-1302	-13 13/16-16	-13 13/16-16	-02 1/8-28	27	23.8
A9FG-1602	-16 1-14	-16 1-14	-02 1/8-28	27	28.6
A9FG-1902	-19 1.3/16-12	-19 1.3/16-12	-02 1/8-28	32	34.9
A9FG-2302	-23 1.7/16-12	-23 1.7/16-12	-02 1/8-28	38	41.3

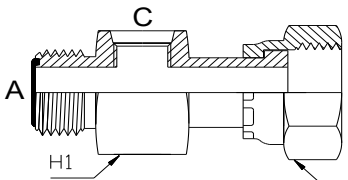
A9FO
ORFS (UNO Port) Test Point Adaptor

Item No	A-ORFS	B-ORFS	C-UNO	H1	H
A9FO-0907	-09 9/16-18	-09 9/16-18	-07 7/16-20	27	17.5
A9FO-1107	-11 11/16-16	-11 11/16-16	-07 7/16-20	27	20.6
A9FO-1307	-13 13/16-16	-13 13/16-16	-07 7/16-20	27	23.8
A9FO-1607	-16 1-14	-16 1-14	-07 7/16-20	27	28.6
A9FO-1907	-19 1.3/16-12	-19 1.3/16-12	-07 7/16-20	32	34.9
A9FG-2302	-23 1.7/16-12	-23 1.7/16-12	-07 7/16-20	38	41.3

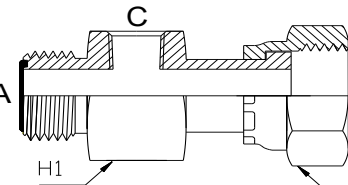
A9FT
ORFS (BSPT Port) Test Point Adaptor

Item No	A-ORFS	B-ORFS	C-BSPT	H1	H
A9FT-0902	-09 9/16-18	-09 9/16-18	-02 1/8-28	27	17.5
A9FT-1102	-11 11/16-16	-11 11/16-16	-02 1/8-28	27	20.6
A9FT-1302	-13 13/16-16	-13 13/16-16	-02 1/8-28	27	23.8
A9FT-1602	-16 1-14	-16 1-14	-02 1/8-28	27	28.6
A9FT-1902	-19 1.3/16-12	-19 1.3/16-12	-02 1/8-28	32	34.9
A9FT-2302	-23 1.7/16-12	-23 1.7/16-12	-02 1/8-28	38	41.3

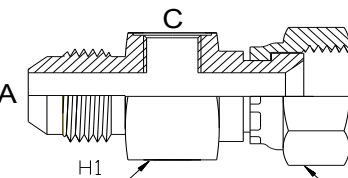
A9JG
JIC (BSPP Port) Test Point Adaptor

Item No	A-JIC	B-JIC	C-BSPP	H1	H
A9JG-0702	-07 7/16-20	-07 7/16-20	-02 1/8-28	27	14.3
A9JG-0902	-09 9/16-18	-09 9/16-18	-02 1/8-28	27	17.5
A9JG-1202	-12 3/4-16	-12 3/4-16	-02 1/8-28	27	22.2
A9JG-1402	-14 7/8-14	-14 7/8-14	-02 1/8-28	27	25.4
A9JG-1702	-17 1.1/16-12	-17 1.1/16-12	-02 1/8-28	32	31.8
A9JG-2102	-21 1.5/16-12	-21 1.5/16-12	-02 1/8-28	38	38 *

A9JO
JIC (UNO Port) Test Point Adaptor

	Item No	A-JIC	B-JIC	C-UNO	H1	H
	A9JO-0707	-07 7/16-20	-07 7/16-20	-07 7/16-20	27	14.3
	A9JO-0907	-09 9/16-18	-09 9/16-18	-07 7/16-20	27	17.5
	A9JO-1207	-12 3/4-16	-12 3/4-16	-07 7/16-20	27	22.2
	A9JO-1407	-14 7/8-14	-14 7/8-14	-07 7/16-20	27	25.4
	A9JO-1707	-17 1.1/16-12	-17 1.1/16-12	-07 7/16-20	32	31.8
	A9JO-2107	-21 1.5/16-12	-21 1.5/16-12	-07 7/16-20	38	38 *
	A9JO-2607	-26 1.5/8-12	-26 1.5/8-12	-07 7/16-20	46	50 *

A9JT
JIC (BSPT Port) Test Point Adaptor

	Item No	A-JIC	B-JIC	C-BSPT	H1	H
	A9JT-0702	-07 7/16-20	-07 7/16-20	-02 1/8-28		14.3
	A9JT-0902	-09 9/16-18	-09 9/16-18	-02 1/8-28		17.5
	A9JT-1202	-12 3/4-16	-12 3/4-16	-02 1/8-28		22.2
	A9JT-1402	-14 7/8-14	-14 7/8-14	-02 1/8-28		25.4
	A9JT-1702	-17 1.1/16-12	-17 1.1/16-12	-02 1/8-28		31.8
	A9JT-2102	-21 1.5/16-12	-21 1.5/16-12	-02 1/8-28		38 *

TP
Test Point

	Item No	A	B
	BTC20-G02-PC	M16x2.0	BSPP 1/8 Male
	BTC20-G04-PC	M16x2.0	BSPP 1/4 Male
	BTC20-G06-PC	M16x2.0	BSPP 3/8 Male
	BTC20-G08-PC	M16x2.0	BSPP 1/2 Male
	BTC20-R02-PD	M16x2.0	BSPT 1/8-28 Male
	BTC20-R04-PD	M16x2.0	BSPT 1/4-19 Male
	BTC20-R06-PD	M16x2.0	BSPT 3/8-19 Male
	BTC20-M12-PC	M16x2.0	Metric M12x1.5 Male
	BTC20-M14-PC	M16x2.0	Metric M14x1.5 Male
	BTC20-M16-PC	M16x2.0	Metric M16x1.5 Male
	BTC20-NPTF02-PD	M16x2.0	NPT 1/8-27 Male
	BTC20-NPTF04-PD	M16x2.0	NPT 1/4-18 Male
	BTC20-NPTF06-PD	M16x2.0	NPT 3/8-18 Male
	BTC20-UNF07-PE	M16x2.0	UNO 7/16-20 Male
	BTC20-UNF09-PE	M16x2.0	UNO 9/16-18 Male
	BTC20-UNF12-PE	M16x2.0	UNO 3/4-16 Male
	BUK20-G04-FP-S	M16x2.0	BSPP 1/4-19 Female Swivel
	BUK20-ORF09-FP	M16x2.0	ORFS 9/16-18 Female Swivel
BUK20-ORF11-FP	M16x2.0	ORFS 11/16-18 Female Swivel	
BUK20-UNF06-FP	M16x2.0	JIC 3/8-20 Female Swivel	
BUK20-UNF07-FP	M16x2.0	JIC 7/16-20 Female Swivel	
BUK20-UNF09-FP	M16x2.0	JIC 9/16-18 Female Swivel	

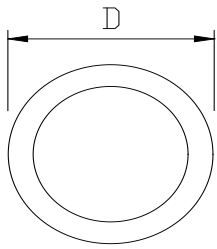
CW
CAT Washer

Item No	D	I.D.	Thickness
CW-12	41	32	5.5
CW-16	48	38	4.7
CW-20	54	44	3.9
CW-24	64	51	1.7
CW-32	79	79	1.7

FSA
SAE Flange Solid Code 61

SAE Specification

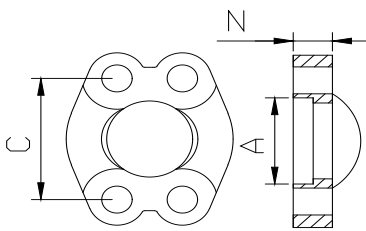

Item No	A	C	N
FSA-08	31.0	38.1	13
FSA-12	38.9	47.6	14
FSA-16	45.3	52.4	16
FSA-20	51.6	58.7	14
FSA-24	61.1	69.9	16
FSA-32	72.3	77.8	16
FSA-40	85.0	88.9	19
FSA-48	102.4	106.4	22

FSAH
SAE Flange Solid Code 62

SAE Specification

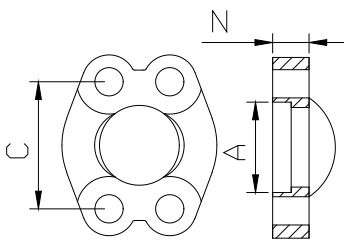

Item No	A	C	N	Bolt Hole
FSAH-08	32.6	40.5	16	8.5
FSAH-12	42.1	50.8	19	10.5
FSAH-16	48.4	57.2	24	10.5
FSAH-20	54.8	66.7	27	12.0
FSAH-20M	54.8	66.7	27	12.5
FSAH-24	64.3	79.4	30	13.5
FSAH-32	80.2	96.8	37	13.5
FSAH-40	108.9	123.8	45	13.5
FSAH-48	132.5	152.4	55	17.0

* For bolt size details FSK - Page 111

FSC
SAE Flange CD 61 Split Clamp

SAE Specification

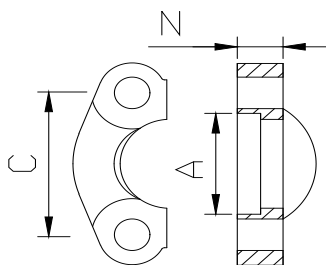

Item No	A	C	N	Bolt Hole
FSC-08	31.0	38.1	13	8.5
FSC-12	38.9	47.6	14	10.5
FSC-16	45.3	52.4	16	10.5
FSC-20	51.6	58.7	14	12.0
FSC-20M	51.6	58.7	14	12.5
FSC-24	61.1	69.9	16	13.5
FSC-32	72.3	77.8	16	13.5
FSC-40	85.0	88.9	19	13.5
FSC-48	102.4	106.4	22	17.0
FSC-56	115.1	120.7	22	17.0
FSC-64	127.8	130.2	25	17.0

* For bolt size details FSK - Page 111

FSCH
SAE Flange CD 62 Split Clamp

SAE Specification

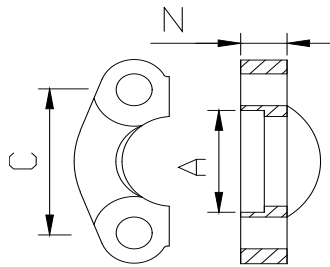

Item No	A	C	N	Bolt Hole
FSCH-08	32.6	40.5	16	8.5
FSCH-12	42.1	50.8	19	10.5
FSCH-16	48.4	57.2	24	13.0
FSCH-20	54.8	66.7	27	13.5
FSCH-20M14	54.8	66.7	27	14.5
FSCH-24	64.3	79.4	30	17.0
FSCH-32	80.2	96.8	37	21.0
FSCH-40	108.9	123.8	45	25.0
FSCH-48	132.5	152.4	55	32.0

* For bolt size details FSKH - Page 112

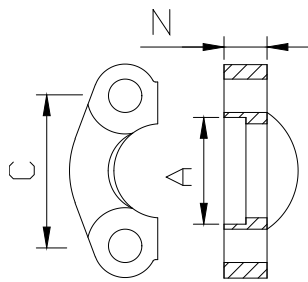
FSCHC
SAE Flange CD 62 CAT Split Clamp

Item No	A	C	N
FSCHC-12	42.1	50.8	28
FSCHC-16	48.4	57.2	28
FSCHC-20	54.8	66.7	28
FSCHC-20	54.8	66.7	28
FSCHC-24	64.3	79.4	32
FSCHC-32	80.2	96.8	36

FSK
SAE Flange CD 61 Split Clamp Kit

SAE Specification

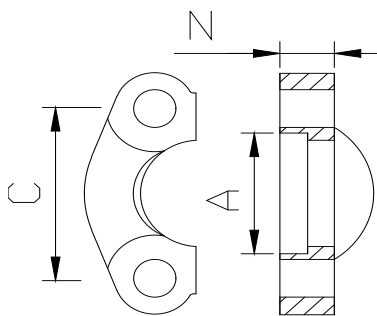

Item No	A	C	N	BOLT
FSK-08M	31.0	38.1	13	M8 * 30
FSK-12M	38.9	47.6	14	M10 * 35
FSK-16M	45.3	52.4	16	M10 * 35
FSK-20M	51.6	58.7	14	M10 * 40
FSK-24M	61.1	69.9	16	M12 * 45
FSK-32M	72.3	77.8	16	M12 * 45
FSK-40M	85.0	88.9	19	M12 * 45
FSK-48M	102.4	106.4	22	M16 * 50
FSK-56M	115.1	120.7	22	M16 * 50
FSK-64M	127.8	130.2	25	M16 * 50
FSK-80M	153.2	152.4	28	M16 * 57
FSK-08U	31.0	38.1	13	UNC 5/16 * 1.1/4
FSK-12U	38.9	47.6	14	UNC 3/8 * 1.1/2
FSK-16U	45.3	52.4	16	UNC 3/8 * 1.1/2
FSK-20U	51.6	58.7	14	UNC 7/16 * 1.1/2
FSK-24U	61.1	69.9	16	UNC 1/2 * 1.3/4
FSK-32U	72.3	77.8	16	UNC 1/2 * 1.3/4
FSK-40U	85.0	88.9	19	UNC 1/2 * 1.3/4
FSK-48U	102.4	106.4	22	UNC 5/8 * 2
FSK-56U	115.1	120.7	22	UNC 5/8 * 2
FSK-64U	127.8	130.2	25	UNC 5/8 * 2
FSK-80U	153.2	152.4	28	UNC 5/8 * 2.1/4

 * Kit includes 1 set clamps, 4 bolts, 4 spring washers, 1 O-Ring
 Bolts are high tensile with socket head.

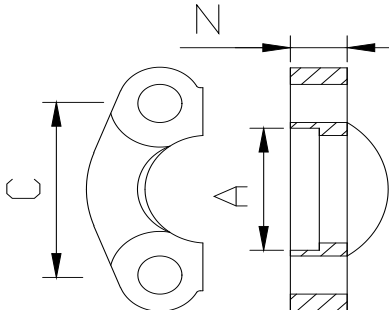
FSKH
SAE Flange CD 62 Split Clamp Kit

Item No	A	C	N	BOLT
FSKH-08M	32.6	40.5	16	M8 * 30
FSKH-12M	42.1	50.8	19	M10 * 35
FSKH-16M	48.4	57.2	24	M12 * 45
FSKH-20M	54.8	66.7	27	M14 * 50
FSKH-24M	64.3	79.4	30	M16 * 55
FSKH-32M	80.2	96.8	37	M20 * 70
FSKH-08U	32.6	40.5	16	UNC 5/16 * 1.1/4
FSKH-12U	42.1	50.8	19	UNC 3/8 * 1.1/2
FSKH-16U	48.4	57.2	24	UNC 7/16 * 1.3/4
FSKH-20U	54.8	66.7	27	UNC 1/2 * 1.3/4
FSKH-24U	64.3	79.4	30	UNC 5/8 * 2
FSKH-32U	80.2	96.8	37	UNC 3/4 * 2.1/2

* Kit includes 1 set clamps, 4 bolts, 4 spring washers, 1 O-Ring
Bolts are high tensile with socket head.

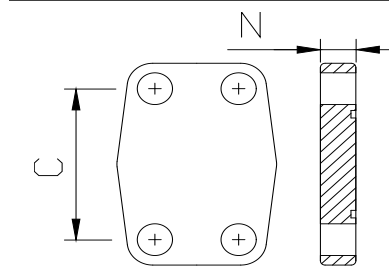
FSBB
SAE Blind Flange CD61

Item No	C	N
FSBB-08	38.1	16
FSBB-12	47.6	16
FSBB-16	52.4	19
FSBB-20	58.7	19
FSBB-24	69.9	20
FSBB-32	77.8	20
FSBB-40	88.9	20
FSBB-48	106.4	24

* Reversible, for use with O-Ring face or flat face.

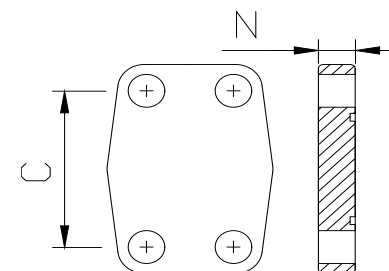
FSBBH
SAE Blind Flange CD62

Item No	C	N
FSBBH-08	40.5	16
FSBBH-12	50.8	19
FSBBH-16	57.2	24
FSBBH-20	66.7	27
FSBBH-24	79.4	30
FSBBH-32	96.8	30

* Reversible, for use with O-Ring face or flat face.

FSG
SAE Flange CD 61 x BSPP Female

	Item No	A-CD61	B-BSPP
	FSG-08	-08 1/2	-08 1/2-14
	FSG-12	-12 3/4	-12 3/4-14
	FSG-16	-16 1	-16 1-11
	FSG-20	-20 1.1/4	-20 1.1/4-11
	FSG-24	-24 1.1/2	-24 1.1/2-11
	FSG-32	-32 2	-32 2-11
	FSG-40	-40 2.1/2	-40 2.1/2-11
	FSG-48	-48 3	-48 3-11

FSGH
SAE Flange CD 62 x BSPP Female

	Item No	A-CD62	B-BSPP
	FSGH-08	-08 1/2	-08 1/2-14
	FSGH-12	-12 3/4	-12 3/4-14
	FSGH-16	-16 1	-16 1-11
	FSGH-20	-20 1.1/4	-20 1.1/4-11
	FSGH-24	-24 1.1/2	-24 1.1/2-11
	FSGH-32	-32 2	-32 2-11

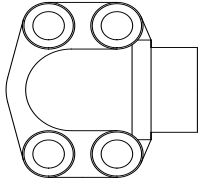
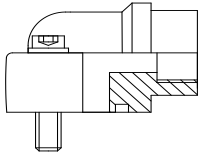
FSG9C
SAE Flange CD 61 x BSPP Female 90 Elbow

Item No	A-CD61	B-BSPP
FSG9C-08	-08 1/2	-08 1/2-14
FSG9C-12	-12 3/4	-12 3/4-14
FSG9C-16	-16 1	-16 1-11
FSG9C-20	-20 1.1/4	-20 1.1/4-11
FSG9C-24	-24 1.1/2	-24 1.1/2-11
FSG9C-32	-32 2	-32 2-11

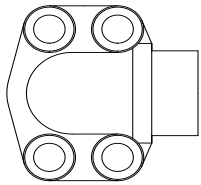
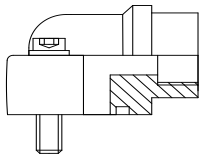
FSGH9C
SAE Flange CD 62 x BSPP Female 90 Elbow

Item No	A-CD62	B-BSPP
FSGH9C-08	-08 1/2	-08 1/2-14
FSGH9C-12	-12 3/4	-12 3/4-14
FSGH9C-16	-16 1	-16 1-11
FSGH9C-20	-20 1.1/4	-20 1.1/4-11
FSGH9C-24	-24 1.1/2	-24 1.1/2-11
FSGH9C-32	-32 2	-32 2-11

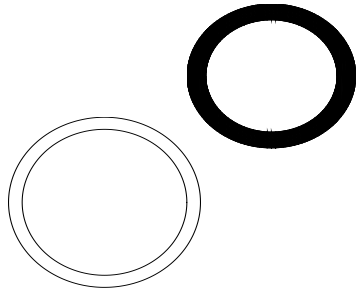
OR-BPA
BSPP Retaining Ring + O-Ring

Set	Component P/N		Where Used	ID	T
	Ret. Ring	O-Ring			
OR-BPA-02	OR-BRR-02	OR-BSP-02	Suit 1/8 BSPP		
OR-BPA-04	OR-BRR-04	OR-BSP-04	Suit 1/4 BSPP	10.8	2.62
OR-BPA-06	OR-BRR-06	OR-BSP-06	Suit 3/8 BSPP	13.9	2.62
OR-BPA-08	OR-BRR-08	OR-BSP-08	Suit 1/2 BSPP	17.1	2.62
OR-BPA-12	OR-BRR-12	OR-BSP-12	Suit 3/4 BSPP	23.5	2.62
OR-BPA-16	OR-BRR-16	OR-BSP-16	Suit 1 BSPP	29.7	3.53
OR-BPA-20	OR-BRR-20	OR-BSP-20	Suit 1.1/4 BSPP	37.7	3.53
OR-BPA-24	OR-BRR-24	OR-BSP-24	Suit 1.1/2 BSPP	44.0	3.53
OR-BPA-32	OR-BRR-32	OR-BSP-32	Suit 2 BSPP	54.0	3.00

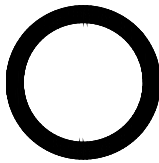
OR-DKO
METRIC DKO L/S O-Ring

Item No	DKOL Size	DKOS Size	ID	T
by Tube Size		For Use With		
OR-DKO-06	M12x1.5	M14x1.5	4.5	1.5
OR-DKO-08	M14x1.5	M16x1.5	6.5	1.5
OR-DKO-10	M16x1.5	M18x1.5	8.0	1.5
OR-DKO-12	M18x1.5	M20x1.5	10.0	1.5
OR-DKO-14		M22x1.5	11.0	2.0
OR-DKO-15	M22x1.5		12.0	2.0
OR-DKO-16		M24x1.5	13.0	2.0
OR-DKO-18	M26x1.5		15.0	2.0
OR-DKO-20		M30x2.0	16.3	2.4
OR-DKO-22	M30x2.0		20.0	2.0
OR-DKO-25		M36x2.0	20.3	2.4
OR-DKO-28	M36x2.0		26.0	2.0
OR-DKO-30		M42x2.0	25.3	2.4
OR-DKO-35	M45x2.0		32.0	2.5
OR-DKO-38		M52x2.0	33.3	2.4
OR-DKO-42	M52x2.0		38.0	2.5

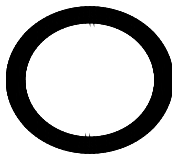
OR-F
ORFS O-Ring

Item No	Where Used	ID	T
OR-F-09	Suit ORFS Male 9/16"	7.64	1.78
OR-F-11	Suit ORFS Male 11/16"	9.25	1.78
OR-F-13	Suit ORFS Male 13/16"	12.42	1.78
OR-F-16	Suit ORFS Male 1"	15.60	1.78
OR-F-19	Suit ORFS Male 1.3/16"	18.77	1.78
OR-F-23	Suit ORFS Male 1.7/16"	23.52	1.78
OR-F-27	Suit ORFS Male 1.11/16"	29.87	1.78
OR-F-32	Suit ORFS Male 2"	37.82	1.78

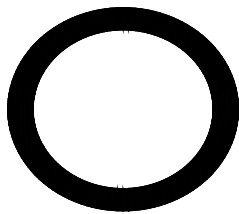
OR-FL
SAE Flange O-Ring

Item No	Where Used	ID	T
OR-FL-08	To Suit SAE Flange 1/2"	18.64	3.53
OR-FL-12	To Suit SAE Flange 3/4"	24.99	3.53
OR-FL-16	To Suit SAE Flange 1"	32.92	3.53
OR-FL-20	To Suit SAE Flange 1.1/4"	37.69	3.53
OR-FL-24	To Suit SAE Flange 1.1/2"	47.22	3.53
OR-FL-32	To Suit SAE Flange 2"	56.74	3.53
OR-FL-40	To Suit SAE Flange 2.1/2"	69.44	3.53
OR-FL-48	To Suit SAE Flange 3"	85.30	3.53

* O-ring suits FL (CD61), FLH (CD62) and CAT

OR-G
Encapsulated Seal

	Item No	suit BSPP	suit METRIC	D1	D2	T
	OR-G-02	BSPP 1/8	M10*1.0	8.4	11.9	1.0
	OR-M-12		M12*1.5	9.8	14.4	1.5
	OR-G-04	BSPP 1/4	M14*1.5	11.6	16.5	1.5
	OR-M-16		M16*1.5	13.8	18.9	1.5
	OR-G-06	BSPP 3/8		14.7	18.9	1.5
	OR-M-18		M18*1.5	15.7	20.9	1.5
	OR-M-20		M20*1.5	17.8	22.9	1.5
	OR-G-08	BSPP 1/2		18.5	23.9	1.5
	OR-M-22		M22*1.5	19.6	24.3	1.5
	OR-M-24		M24*1.5	21.8	26.9	1.5
	OR-G-12	BSPP 3/4	M26*1.5/M27*2	23.9	29.2	1.5
	OR-G-16	BSPP 1	M33*2.0	29.7	35.7	2.0
	OR-G-20	BSPP 1.1/4	M42*2.0	38.8	45.8	2.0
	OR-G-24	BSPP 1.1/2	M48*2.0	44.7	50.7	2.0
	OR-G-32	BSPP 2	M60*2.0	56.1	62.7	2.5

OR-GBC
Bonded Seal (Self Centering)

	Item No	BSPP
	OR-GBC-02	BSPP 1/8
	OR-GBC-04	BSPP 1/4
	OR-GBC-06	BSPP 3/8
	OR-GBC-08	BSPP 1/2
	OR-GBC-12	BSPP 3/4
	OR-GBC-16	BSPP 1
	OR-GBC-20	BSPP 1.1/4
	OR-GBC-24	BSPP 1.1/2
	OR-GBC-32	BSPP 2

OR-GBC*SS
Bonded Seal (Self Centering) 304 Stainless Steel

	Item No	BSPP
	OR-GBC-02SS	BSPP 1/8
	OR-GBC-04SS	BSPP 1/4
	OR-GBC-06SS	BSPP 3/8
	OR-GBC-08SS	BSPP 1/2
	OR-GBC-12SS	BSPP 3/4
	OR-GBC-16SS	BSPP 1

OR-GBS
BSPP Bonded Seal

	Item No	Where Used
	OR-GBS-02	BSPP 1/8
	OR-GBS-04	BSPP 1/4
	OR-GBS-06	BSPP 3/8
	OR-GBS-08	BSPP 1/2
	OR-GBS-12	BSPP 3/4
	OR-GBS-16	BSPP 1
	OR-GBS-20	BSPP 1.1/4
	OR-GBS-24	BSPP 1.1/2
	OR-GBS-32	BSPP 2

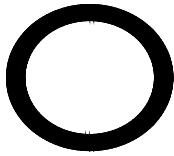
OR-GSP
Pressure Gauge Adaptor O-Ring

Item No		ID	T
OR-GSP04-10	Bag of 10	5.0	1.8
OR-GSP08-10	Bag of 10	6.7	1.8

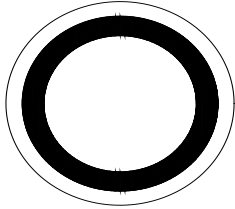
OR-MBS
Metric Bonded Seal

Item No	Use with DIN 3852 Type A	ID	OD	T
OR-MBS-08		8.4	14	1.0
OR-MBS-10		10.4	16	1.5
OR-MBS-12		12.4	18	1.5
OR-MBS-14	*	14.4	20	1.5
OR-MBS-16	*	16.4	22	1.5
OR-MBS-18		18.4	25	1.5
OR-MBS-20		20.5	28	1.5
OR-MBS-22		22.5	30	2.0
OR-MBS-24		24.5	32	2.0
OR-MBS-26		26.5	35	2.0
OR-MBS-27		27.5	35	2.0
OR-MBS-30		30.5	38	2.0
OR-MBS-33		33.5	42	2.0
OR-MBS-36		36.6	46	2.0
OR-MBS-42		42.6	53	3.0
OR-MBS-45		45.6	56	3.0
OR-MBS-48		48.7	60	3.0
OR-MBS-52		52.7	66	3.0

* Available in Stainless Steel. P/N suffix "SS"

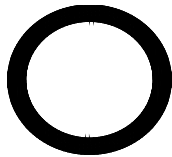
OR-O
UNO O-Ring

Item No	Where Used	Ref AS 568	ID	T
OR-O-05	UNO Ring 5/16		6.07	1.63
OR-O-06	UNO Ring 3/8		7.65	1.63
OR-O-07	UNO Ring 7/16		8.92	1.83
OR-O-08	UNO Ring 1/2		10.52	1.83
OR-O-09	UNO Ring 9/16		11.89	1.98
OR-O-12	UNO Ring 3/4		16.36	2.21
OR-O-14	UNO Ring 7/8		19.18	2.46
OR-O-17	UNO Ring 1.1/16		23.47	2.95
OR-O-19	UNO Ring 1.3/16		26.62	2.95
OR-O-21	UNO Ring 1.5/16		29.74	2.95
OR-O-26	UNO Ring 1.5/8		37.46	3.00
OR-O-30	UNO Ring 1.7/8		43.69	3.00
OR-O-40	UNO Ring 2.1/2		59.36	3.00

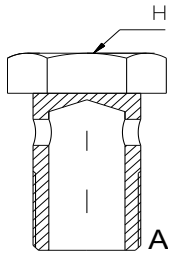
BBB
Banjo Bolt BSP

Item No	A-BSP	L
BBB-02	-02 1/8-28	30
BBB-04	-04 1/4-19	29
BBB-06	-06 3/8-19	39
BBB-08	-08 1/2-14	44
BBB-12	-12 3/4-14	56
BBB-16	-16 1-11	68

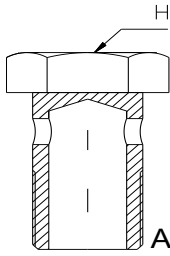
BBM
Banjo Bolt Metric

Item No	A-Metric	L
BBM-1010	-10 M10 *1.0	19
BBM-1215	-12 M12 *1.5	24
BBM-1415	-14 M14 *1.5	26
BBM-1615	-16 M16 *1.5	28
BBM-1815	-18 M18 *1.5	36
BBM-2015	-20 M20 *1.5	39
BBM-2215	-22 M22 *1.5	39
BBM-2615	-26 M26 *1.5	45
BBM-3015	-30 M30 *1.5	51

METRIC COMPRESSION
NL / NS
Metric Compression Nut

	Item No	DKL	For use with Cutting Ring	H
	NLL-08	M08x1.0 (04LL)	RLL-04	10
	NLL-10	M10x1.0 (06LL)	RLL-06	12
	NLL-12	M12x1.0 (08LL)	RLL-08	14
	NL-12	M12x1.5 (06L)	RL/S-06	14
	NL-14	M14x1.5 (08L)	RL/S-08	17
	NL-16	M16x1.5 (10L)	RL/S-10	19
	NL-18	M18x1.5 (12L)	RL/S-12	22
	NL-22	M22x1.5 (15L)	RL-15	27
	NL-26	M26x1.5 (18L)	RL-18	32
	NL-30	M30x2 (22L)	RL-22	36
	NL-36	M36x2 (28L)	RL-28	41
	NL-45	M45x2 (35L)	RL-35	50
	NL-52	M52x2 (42L)	RL-42	60
	NS-14	M14x1.5 (06S)	RL/S-06	17
	NS-16	M16x1.5 (08S)	RL/S-08	19
	NS-18	M18x1.5 (10S)	RL/S-10	22
	NS-20	M20x1.5 (12S)	RL/S-12	24
	NS-22	M22x1.5 (14S)	RS-14	27
	NS-24	M24x1.5 (16S)	RS-16	30
	NS-30	M30x2 (20S)	RS-20	36
	NS-36	M36x2 (25S)	RS-25	46
	NS-42	M42x2 (30S)	RS-30	50
	NS-52	M52x2 (38S)	RS-38	60

RL / RS
Metric Cutting Ring

	Item No	Tube Dia	Suit
	RL-04	4mm	DKLL
	RL-06	6mm	DKLL
	RL-08	8mm	DKLL
	RL/S-06	6mm	DKL & DKS
	RL/S-08	8mm	DKL & DKS
	RL/S-10	10mm	DKL & DKS
	RL/S-12	12mm	DKL & DKS
	RL-15	15mm	DKL
	RL-18	18mm	DKL
	RL-22	22mm	DKL
	RL-28	28mm	DKL
	RL-35	35mm	DKL
	RL-42	42mm	DKL
	RS-14	14mm	DKS
	RS-16	16mm	DKS
	RS-20	20mm	DKS
	RS-25	25mm	DKS
RS-30	30mm	DKS	
RS-38	38mm	DKS	

1C
DKL Male x DKL Male

	Item No	A-DKL	B-DKL	L	H1	
	1C-08LL	M08x1.0 (04LL)	M08x1.0 (04LL)		12	
	1C-10LL	M10x1.0 (06LL)	M10x1.0 (06LL)		12	
	1C-12LL	M12x1.0 (08LL)	M12x1.0 (08LL)		12	
	1C-12	M12x1.5 (06L)	M12x1.5 (06L)		12	
	1C-14	M14x1.5 (08L)	M14x1.5 (08L)		14	
	1C-16	M16x1.5 (10L)	M16x1.5 (10L)		17	
	1C-18	M18x1.5 (12L)	M18x1.5 (12L)		19	
	B 1C-22	M22x1.5 (15L)	M22x1.5 (15L)		24	
	1C-26	M26x1.5 (18L)	M26x1.5 (18L)		27	
	1C-30	M30x2 (22L)	M30x2 (22L)		32	
	1C-36	M36x2 (28L)	M36x2 (28L)		41	
	1C-45	M45x2 (35L)	M45x2 (35L)		46	
	1C-52	M52x2 (42L)	M52x2 (42L)		55	
		1C-1412	M14x1.5 (08L)	M12x1.5 (06L)		14
		1C-1612	M16x1.5 (10L)	M12x1.5 (06L)		17
		1C-1614	M16x1.5 (10L)	M14x1.5 (08L)		17
		1C-1812	M18x1.5 (12L)	M12x1.5 (06L)		19
		1C-1814	M18x1.5 (12L)	M14x1.5 (08L)		19
	1C-1816	M18x1.5 (12L)	M16x1.5 (10L)		19	
	1C-2216	M22x1.5 (15L)	M16x1.5 (10L)		24	
	1C-2218	M22x1.5 (15L)	M18x1.5 (12L)		24	
	1C-2618	M26x1.5 (18L)	M18x1.5 (12L)		27	
	1C-2622	M26x1.5 (18L)	M22x1.5 (15L)		27	
	1C-3022	M30x2 (22L)	M22x1.5 (15L)		32	
	1C-3026	M30x2 (22L)	M26x1.5 (18L)		32	
	1C-3626	M36x2 (28L)	M26x1.5 (18L)		41	
	1C-3630	M36x2 (28L)	M30x2 (22L)		41	
	1C-4530	M45x2 (35L)	M30x2 (22L)		46	
	1C-4536	M52x2 (42L)	M36x2 (28L)		46	

1D
DKS Male x DKS Male Adaptor

	Item No	A-DKS	B-DKS	L	H1
	1D-14	M14x1.5 (06S)	M14x1.5 (06S)		14
	1D-16	M16x1.5 (08S)	M16x1.5 (08S)		17
	1D-18	M18x1.5 (10S)	M18x1.5 (10S)		19
	1D-20	M20x1.5 (12S)	M20x1.5 (12S)		22
	1D-22	M22x1.5 (14S)	M22x1.5 (14S)		24
	1D-24	M24x1.5 (16S)	M24x1.5 (16S)		27
	1D-30	M30x2 (20S)	M30x2 (20S)		32
	1D-36	M36x2 (25S)	M36x2 (25S)		41
	1D-42	M42x2 (30S)	M42x2 (30S)		46
	1D-52	M52x2 (38S)	M52x2 (38S)		55
	1D-1614	M16x1.5 (08S)	M14x1.5 (06S)		17
	1D-1814	M18x1.5 (10S)	M14x1.5 (06S)		22
	1D-1816	M18x1.5 (10S)	M16x1.5 (08S)		22
	1D-2014	M20x1.5 (12S)	M14x1.5 (06S)		22
	1D-2016	M20x1.5 (12S)	M16x1.5 (08S)		22
	1D-2018	M20x1.5 (12S)	M18x1.5 (10S)		22
	1D-2218	M22x1.5 (14S)	M18x1.5 (10S)		24
	1D-2220	M22x1.5 (14S)	M20x1.5 (12S)		24
	1D-2420	M24x1.5 (16S)	M20x1.5 (12S)		27
	1D-2422	M24x1.5 (16S)	M22x1.5 (14S)		27
	1D-3018	M30x2 (20S)	M18x1.5 (10S)		32
	1D-3020	M30x2 (20S)	M20x1.5 (12S)		32
	1D-3024	M30x2 (20S)	M24x1.5 (16S)		32
	1D-3624	M36x2 (25S)	M24x1.5 (16S)		41
	1D-3630	M36x2 (25S)	M30x2 (20S)		41
1D-4230	M42x2 (30S)	M30x2 (20S)		46	
1D-4236	M42x2 (30S)	M36x2 (25S)		46	
1D-5242	M52x2 (38S)	M42x2 (30S)		55	

1C9
DKL Male x DKL Male 90 Elbow

	Item No	A-DKL	B-DKL	S1
	1C9-08LL	M08x1.0 (04LL)	M08x1.0 (04LL)	
	1C9-10LL	M10x1.0 (06LL)	M10x1.0 (06LL)	
	1C9-12LL	M12x1.0 (08LL)	M12x1.0 (08LL)	
	1C9-12	M12x1.5 (06L)	M12x1.5 (06L)	
	1C9-14	M14x1.5 (08L)	M14x1.5 (08L)	
	1C9-16	M16x1.5 (10L)	M16x1.5 (10L)	
	1C9-18	M18x1.5 (12L)	M18x1.5 (12L)	
	1C9-22	M22x1.5 (15L)	M22x1.5 (15L)	
	1C9-26	M26x1.5 (18L)	M26x1.5 (18L)	
	1C9-30	M30x2 (22L)	M30x2 (22L)	
	1C9-36	M36x2 (28L)	M36x2 (28L)	
	1C9-45	M45x2 (35L)	M45x2 (35L)	
	1C9-52	M52x2 (42L)	M52x2 (42L)	

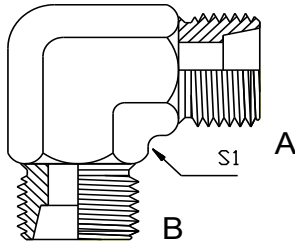
1D9
DKS Male x DKS Male 90 Elbow

Item No	A-DKS	B-DKS	S1
1D9-14	M14x1.5 (06S)	M14x1.5 (06S)	
1D9-16	M16x1.5 (08S)	M16x1.5 (08S)	
1D9-18	M18x1.5 (10S)	M18x1.5 (10S)	
1D9-20	M20x1.5 (12S)	M20x1.5 (12S)	
1D9-22	M22x1.5 (14S)	M22x1.5 (14S)	
1D9-24	M24x1.5 (16S)	M24x1.5 (16S)	
1D9-30	M30x2 (20S)	M30x2 (20S)	
1D9-36	M36x2 (25S)	M36x2 (25S)	
1D9-42	M42x2 (30S)	M42x2 (30S)	
1D9-52	M52x2 (38S)	M52x2 (38S)	

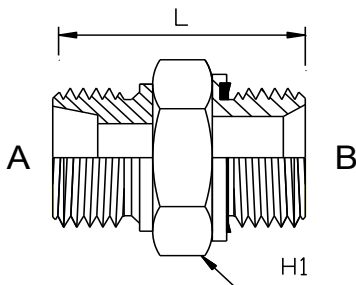
1CG
DKL Male x BSPP Male Encapsulated Seal

Item No	A-DKL	B-BSPP ES	L	H1
1CG-0802LL	M08x1.0 (04LL)	G1/8X28	24	14
1CG-1002LL	M10x1.0 (06LL)	G1/8X28	24	14
1CG-1202LL	M12x1.0 (08LL)	G1/8X28		
1CG-1202	M12x1.5 (06L)	G1/8X28		
1CG-1204	M12x1.5 (06L)	G1/4X19		
1CG-1206	M12x1.5 (06L)	G3/8X19		
1CG-1404	M14x1.5 (08L)	G1/4X19		
1CG-1406	M14x1.5 (08L)	G3/8X19		
1CG-1408	M14x1.5 (08L)	G1/2X14		
1CG-1602	M16x1.5 (10L)	G1/8X28	27	17
1CG-1604	M16x1.5 (10L)	G1/4X19		
1CG-1606	M16x1.5 (10L)	G3/8X19		
1CG-1608	M16x1.5 (10L)	G1/2X14		
1CG-1804	M18x1.5 (12L)	G1/4X19		
1CG-1806	M18x1.5 (12L)	G3/8X19		
1CG-1808	M18x1.5 (12L)	G1/2X14		
1CG-2204	M22x1.5 (15L)	G1/4X19		
1CG-2206	M22x1.5 (15L)	G3/8X19		
1CG-2208	M22x1.5 (15L)	G1/2X14		
1CG-2212	M22x1.5 (15L)	G3/4X14		
1CG-2608	M26x1.5 (18L)	G1/2X14		
1CG-2612	M26x1.5 (18L)	G3/4X14		
1CG-3008	M30x2 (22L)	G1/2X14		
1CG-3012	M30x2 (22L)	G3/4X14		
1CG-3016	M30x2 (22L)	G1X11		
1CG-3020	M30x2 (22L)	G1.1/4X11		
1CG-3612	M36x2 (28L)	G3/4X14		
1CG-3616	M36x2 (28L)	G1X11		
1CG-3620	M36x2 (28L)	G1.1/4X11		
1CG-4516	M45x2 (35L)	G1X11		
1CG-4520	M45x2 (35L)	G1.1/4X11		
1CG-4524	M45x2 (35L)	G1.1/2X11		
1CG-5220	M52x2 (42L)	G1.1/4X11		
1CG-5224	M52x2 (42L)	G1.1/2X11		
1CG-5232	M52x2 (42L)	G2-11		

- Nut and Cutting Ring not included

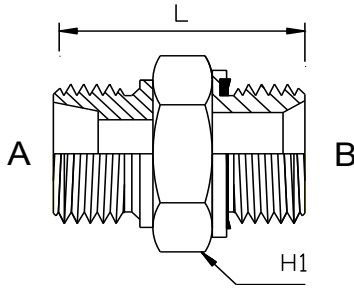
1DG
DKS Male x BSPP Male Encapsulated Seal

Item No	A-DKS	B-BSPP ES
1DG-1404	M14x1.5 (06S)	G1/4X19
1DG-1406	M14x1.5 (06S)	G3/8X19
1DG-1604	M16x1.5 (08S)	G1/4X19
1DG-1606	M16x1.5 (08S)	G3/8X19
1DG-1804	M18x1.5 (10S)	G1/4X19
1DG-1806	M18x1.5 (10S)	G3/8X19
1DG-1808	M18x1.5 (10S)	G1/2X14
1DG-2004	M20x1.5 (12S)	G1/4X19
1DG-2006	M20x1.5 (12S)	G3/8X19
1DG-2008	M20x1.5 (12S)	G1/2X14
1DG-2206	M22x1.5 (14S)	G3/8X19
1DG-2208	M22x1.5 (14S)	G1/2X14
1DG-2212	M22x1.5 (14S)	G3/4X14
1DG-2406	M24x1.5 (16S)	G3/8X19
1DG-2408	M24x1.5 (16S)	G1/2X14
1DG-2412	M24x1.5 (16S)	G3/4X14
1DG-3008	M30x2 (20S)	G1/2X14
1DG-3012	M30x2 (20S)	G3/4X14
1DG-3016	M30x2 (20S)	G1X11
1DG-3612	M36x2 (25S)	G3/4X14
1DG-3616	M36x2 (25S)	G1X11
1DG-3620	M36x2 (25S)	G1.1/4X11
1DG-4216	M42x2 (30S)	G1X11
1DG-4220	M42x2 (30S)	G1.1/4X11
1DG-5220	M52x2 (38S)	G1.1/4X11
1DG-5224	M52x2 (38S)	G1.1/2X11

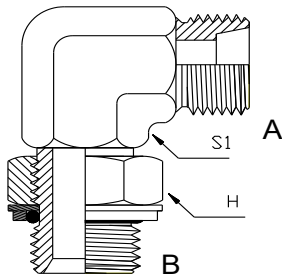
1CG9
DKL Male x BSPP Male 90 Elbow

Item No	A-DKL	B-BSPP
1CG9-1202	M12x1.5 (06L)	G1/8X28
1CG9-1404	M14x1.5 (08L)	G1/4X19
1CG9-1406	M14x1.5 (08L)	G3/8X19
1CG9-1604	M16x1.5 (10L)	G1/4X19
1CG9-1606	M16x1.5 (10L)	G3/8X19
1CG9-1608	M16x1.5 (10L)	G1/2X14
1CG9-1804	M18x1.5 (12L)	G1/4X19
1CG9-1806	M18x1.5 (12L)	G3/8X19
1CG9-1806	M18x1.5 (12L)	G3/8X19
1CG9-1808	M18x1.5 (12L)	G1/2X14
1CG9-2208	M22x1.5 (15L)	G1/2X14
1CG9-2212	M22x1.5 (15L)	G3/4X14
1CG9-2608	M26x1.5 (18L)	G1/2X14
1CG9-2612	M26x1.5 (18L)	G3/4X14
1CG9-3012	M30x2 (22L)	G3/4X14
1CG9-3616	M36x2 (28L)	G1X11
1CG9-4520	M45x2 (35L)	G1.1/4X11

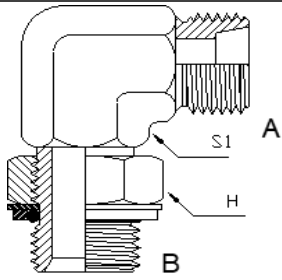
1DG9
DKS Male x BSPP Male 90 Elbow

Item No	A-DKS	B-BSPP
1DG9-1404	M14x1.5 (06S)	G1/4X19
1DG9-1604	M16x1.5 (08S)	G1/4X19
1DG9-1806	M18x1.5 (10S)	G3/8X19
1DG9-2006	M20x1.5 (12S)	G3/8X19
1DG9-2408	M24x1.5 (16S)	G1/2X14
1DG9-3012	M30x2 (20S)	G3/4X14
1DG9-3616	M36x2 (25S)	G1X11
1DG9-4220	M42x2 (30S)	G1.1/4X11

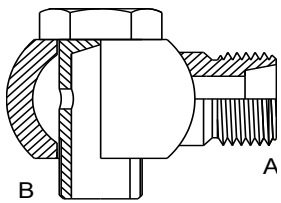
1CI
DKOL METRIC BANJO ADAPTOR

Item No	A-DKL	B-BANJO
1CI-1210	M12x1.5 (06L)	-10 M10x1.0
1CI-1412	M14x1.5 (08L)	-12 M12x1.5
1CI-1614	M16x1.5 (10L)	-14 M14x1.5
1CI-1816	M18x1.5 (12L)	-16 M16x1.5
1CI-14-B04	M14x1.5 (08L)	G1/4X19
1CI-16-B04	M16x1.5 (10L)	G1/4X19
1CI-18-B06	M18x1.5 (12L)	G3/8X19
1CI-22-B08	M22x1.5 (15L)	G1/2X14
1CI-26-B08	M26x1.5 (18L)	G1/2X14
1CI-30-B12	M30x2 (22L)	G3/4X14
1CI-36-B16	M36x2 (28L)	G1X11

1CM
DKL Male x Metric Male ES

Encapsulated Seal Type

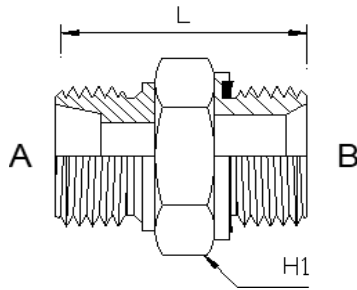

Item No	A-DKL	B-METRIC
1CM-0808LL	M08x1.0 (04LL)	-08 M08x1.0
1CM-1006LL	M10x1.0 (06LL)	-08 M06x1.0
1CM-1010LL	M10x1.0 (06LL)	-10 M10x1.0
1CM-1210LL	M12x1.0 (08LL)	-10 M10x1.0
1CM-1210	M12x1.5 (06L)	-10 M10x1.0
1CM-1212	M12x1.5 (06L)	-12 M12x1.5
1CM-1214	M12x1.5 (06L)	-14 M14x1.5
1CM-1410	M14x1.5 (08L)	-12 M12x1.5
1CM-1412	M14x1.5 (08L)	-12 M12x1.5
1CM-1414	M14x1.5 (08L)	-14 M14x1.5
1CM-1416	M14x1.5 (08L)	-16 M16x1.5
1CM-1418	M14x1.5 (08L)	-18 M18x1.5
1CM-1610	M16x1.5 (10L)	-10 M10x1.0
1CM-1612	M16x1.5 (10L)	-12 M12x1.5
1CM-1614	M16x1.5 (10L)	-14 M14x1.5
1CM-1616	M16x1.5 (10L)	-16 M16x1.5
1CM-1618	M16x1.5 (10L)	-18 M18x1.5
1CM-1620	M16x1.5 (10L)	-20 M20x1.5
1CM-1622	M16x1.5 (10L)	-22 M22x1.5
1CM-1812	M18x1.5 (12L)	-12 M12x1.5
1CM-1814	M18x1.5 (12L)	-14 M14x1.5
1CM-1816	M18x1.5 (12L)	-16 M16x1.5
1CM-1818	M18x1.5 (12L)	-18 M18x1.5
1CM-1822	M18x1.5 (12L)	-22 M22x1.5
1CM-1827	M18x1.5 (12L)	-27 M27x2.0
1CM-2216	M22x1.5 (15L)	-16 M16x1.5
1CM-2218	M22x1.5 (15L)	-18 M18x1.5
1CM-2220	M22x1.5 (15L)	-20 M20x1.5
1CM-2222	M22x1.5 (15L)	-22 M22x1.5
1CM-2226	M22x1.5 (15L)	-26 M26x1.5
1CM-2227	M22x1.5 (15L)	-27 M27x2.0
1CM-2242	M22x1.5 (15L)	-42 M42x2.0
1CM-2618	M26x1.5 (18L)	-18 M18x1.5
1CM-2620	M26x1.5 (18L)	-20 M20x1.5
1CM-2622	M26x1.5 (18L)	-22 M22x1.5
1CM-2626	M26x1.5 (18L)	-26 M26x1.5
1CM-2627	M26x1.5 (18L)	-27 M27x2.0
1CM-2633	M26x1.5 (18L)	-33 M33x2.0
1CM-3018	M30x2 (22L)	-18 M18x1.5
1CM-3020	M30x2 (22L)	-20 M20x1.5
1CM-3022	M30x2 (22L)	-22 M22x1.5
1CM-3026	M30x2 (22L)	-26 M26x1.5
1CM-3027	M30x2 (22L)	-27 M27x2.0
1CM-3033	M30x2 (22L)	-33 M33x2.0
1CM-3042	M30x2 (22L)	-42 M42x2.0
1CM-3626	M36x2 (28L)	-26 M26x1.5
1CM-3627	M36x2 (28L)	-27 M27x2.0
1CM-3633	M36x2 (28L)	-33 M33x2.0
1CM-3642	M36x2 (28L)	-42 M42x2.0
1CM-4533	M45x2 (35L)	-33 M33x2.0
1CM-4542	M45x2 (35L)	-42 M42x2.0
1CM-4548	M45x2 (35L)	-48 M48x2.0
1CM-5248	M52x2 (42L)	-48 M48x2.0

1DM
DKS Male x Metric Male ES

Encapsulated Seal Type

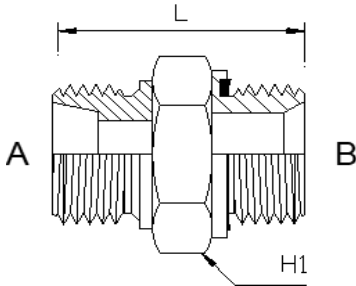

Item No	A-DKS	B-MERIC
1DM-1614	M16x1.5 (08S)	-14 M14x1.5
1DM-1814	M18x1.5 (10S)	-14 M14x1.5
1DM-1816	M18x1.5 (10S)	-16 M16x1.5
1DM-2018	M20x1.5 (12S)	-18 M18x1.5
1DM-2022	M20x1.5 (12S)	-22 M22x1.5
1DM-2220	M22x1.5 (14S)	-20 M20x1.5
1DM-2422	M24x1.5 (16S)	-22 M22x1.5
1DM-3022	M30x2 (20S)	-22 M22x1.5
1DM-3026	M30x2 (20S)	-26 M26x1.5
1DM-3027	M30x2 (20S)	-27 M27x2.0
1DM-3033	M30x2 (20S)	-33 M33x2.0
1DM-3048	M30x2 (20S)	-48 M48x2.0
1DM-3627	M36x2 (25S)	-27 M27x2.0
1DM-3633	M36x2 (25S)	-33 M33x2.0
1DM-4242	M42x2 (30S)	-42 M42x2.0
1DM-5248	M52x2 (38S)	-48 M48x2.0

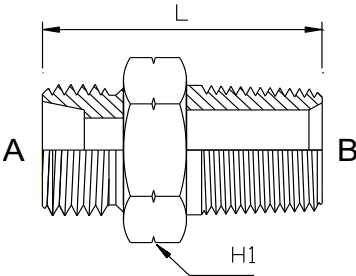
1CN
DKL Male x NPT Male

Item No	A-DKL	B-NPT
1CN-1202	M12x1.5 (06L)	1/8x27
1CN-1204	M12x1.5 (06L)	1/4x18
1CN-1404	M14x1.5 (08L)	1/4x18
1CN-1406	M14x1.5 (08L)	3/8x18
1CN-1602	M16x1.5 (10L)	1/8x27
1CN-1604	M16x1.5 (10L)	1/4x18
1CN-1606	M16x1.5 (10L)	3/8x18
1CN-1804	M18x1.5 (12L)	1/4x18
1CN-1806	M18x1.5 (12L)	3/8x18
1CN-1808	M18x1.5 (12L)	1/2x14
1CN-2206	M22x1.5 (15L)	3/8x18
1CN-2208	M22x1.5 (15L)	1/2x14
1CN-2606	M26x1.5 (18L)	3/8x18
1CN-2608	M26x1.5 (18L)	1/2x14
1CN-2612	M26x1.5 (18L)	3/4x14
1CN-3008	M30x2 (22L)	1/2x14
1CN-3012	M30x2 (22L)	3/4x14
1CN-3016	M30x2 (22L)	1x11.5
1CN-3616	M36x2 (28L)	1x11.5
1CN-3620	M36x2 (28L)	1.1/4x11.5
1CN-4520	M45x2 (35L)	1.1/4x11.5
1CN-5224	M52x2 (42L)	1.1/211.5

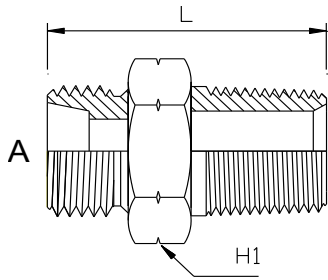
1DN
DKS Male x NPT Male

Item No	A-DKS	B-NPT
1DN-1404	M14x1.5 (06S)	1/4-18
1DN-1604	M16x1.5 (08S)	1/4-18
1DN-1804	M18x1.5 (10S)	1/4-18
1DN-1806	M18x1.5 (10S)	3/8-18
1DN-2006	M20x1.5 (12S)	3/8-18
1DN-2408	M24x1.5 (16S)	1/2-14
1DN-3012	M30x2 (20S)	3/4-14
1DN-3612	M36x2 (25S)	3/4-14
1DN-3616	M36x2 (25S)	1-11.5
1DN-5220	M52x2 (38S)	1.1/4-11.5
1DN-5224	M52x2 (38S)	1.1/2-11.5

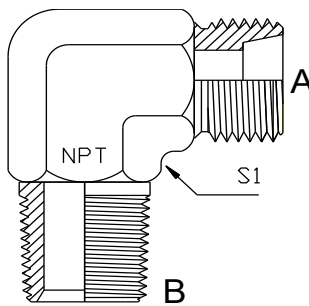
1CN9
DKL Male x NPT Male 90 Elbow

Item No	A-DKL	B-NPT
1CN9-1202	M12x1.5 (06L)	1/8-27
1CN9-1204	M12x1.5 (06L)	1/4-18
1CN9-1404	M14x1.5 (08L)	1/4-18
1CN9-1604	M16x1.5 (10L)	1/4-18
1CN9-1606	M16x1.5 (10L)	3/8-18
1CN9-1805	M18x1.5 (12L)	1/4-18
1CN9-1806	M18x1.5 (12L)	3/8-18
1CN9-1808	M18x1.5 (12L)	1/2-14
1CN9-2206	M22x1.5 (15L)	3/8-18
1CN9-2208	M22x1.5 (15L)	1/2-14
1CN9-2608	M26x1.5 (18L)	1/2-14
1CN9-2612	M26x1.5 (18L)	3/4-14
1CN9-3012	M30x2 (22L)	3/4-14
1CN9-3016	M30x2 (22L)	1-11.5
1CN9-3616	M36x2 (28L)	1-11.5

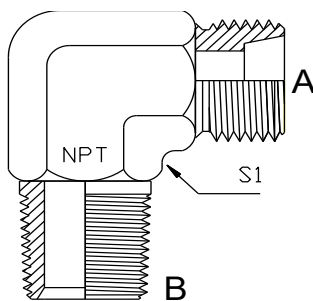
1DN9
DKS Male x NPT Male 90 Elbow

Item No	A-DKS	B-NPT
1DN9-1404	M14x1.5 (06S)	1/4x18
1DN9-1604	M16x1.5 (08S)	1/4x18
1DN9-1806	M18x1.5 (10S)	3/8x18
1DN9-2006	M20x1.5 (12S)	3/8x18
1DN9-2408	M24x1.5 (16S)	1/2x14
1DN9-3012	M30x2 (20S)	3/4x14
1DN9-3612	M36x2 (25S)	3/4x14
1DN9-3616	M36x2 (25S)	1x11.5

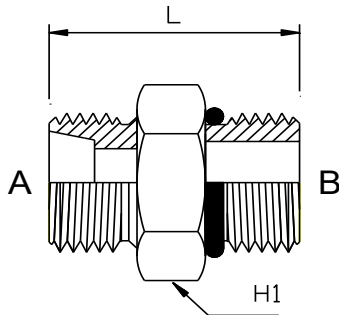
1CO
DKL Male x UNO Male

Item No	A-DKL	B-UNO
1CO-1407	M14x1.5 (08L)	7/16X20
1CO-1407	M14x1.5 (08L)	9/16x18
1CO-1407	M14x1.5 (08L)	3/4X16
1CO-1607	M16x1.5 (10L)	7/16X20
1CO-1609	M16x1.5 (10L)	9/16x18
1CO-1612	M16x1.5 (10L)	3/4X16
1CO-1809	M18x1.5 (12L)	9/16x18
1CO-1812	M18x1.5 (12L)	3/4X16
1CO-1814	M18x1.5 (12L)	7/8X14
1CO-2212	M22x1.5 (15L)	3/4X16
1CO-2214	M22x1.5 (15L)	7/8X14
1CO-2217	M22x1.5 (15L)	1.1/16X12
1CO-2612	M26x1.5 (18L)	3/4X16
1CO-2614	M26x1.5 (18L)	7/8X14
1CO-2617	M26x1.5 (18L)	1.1/16X12
1CO-3014	M30x2 (22L)	7/8X14
1CO-3017	M30x2 (22L)	1.1/16X12
1CO-3021	M30x2 (22L)	1.5/16X12
1CO-3617	M36x2 (28L)	1.1/16X12
1CO-3621	M36x2 (28L)	1.5/16X12
1CO-4521	M45x2 (35L)	1.5/16X12
1CO-4526	M45x2 (35L)	1.5/8X12
1CO-5226	M52x2 (42L)	1.5/8X12

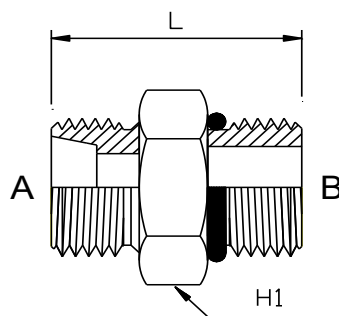
1DO
DKS Male x UNO Male

Item No	A-DKS	B-UNO
1DO-1607	M16x1.5 (08S)	7/16X20
1DO-1809	M18x1.5 (10S)	9/16X18
1DO-2009	M20x1.5 (12S)	9/16X18
1DO-2012	M20x1.5 (12S)	3/4X16
1DO-2014	M20x1.5 (12S)	7/8X14
1DO-2412	M24x1.5 (16S)	3/4X16
1DO-2414	M24x1.5 (16S)	7/8X14
1DO-3012	M30x2 (20S)	3/4X16
1DO-3014	M30x2 (20S)	7/8X14
1DO-3017	M30x2 (20S)	1.1/16X12
1DO-3617	M36x2 (25S)	1.1/16X12
1DO-3621	M36x2 (25S)	1.5/16X12
1DO-4221	M42x2 (30S)	1.5/16X12
1DO-4226	M42x2 (30S)	1.5/8X12
1DO-5226	M52x2 (38S)	1.5/8X12

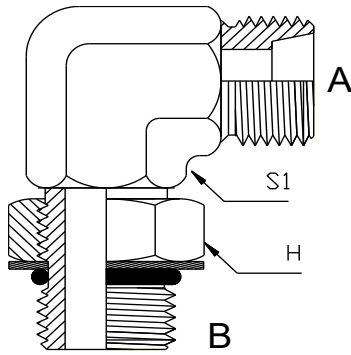
1CO9
DKL Male x UNO Male 90 Elbow

Item No	A-DKL	B-UNO
1CO9-1407	M14x1.5 (08L)	7/16X20
1CO9-1409	M14x1.5 (08L)	9/16X18
1CO9-1609	M16x1.5 (10L)	9/16X18
1CO9-1809	M18x1.5 (12L)	9/16X18
1CO9-1812	M18x1.5 (12L)	3/4X16
1CO9-2212	M22x1.5 (15L)	3/4X16
1CO9-2214	M22x1.5 (15L)	7/8X14
1CO9-2217	M22x1.5 (15L)	1.1/16X12
1CO9-2614	M26x1.5 (18L)	7/8X14
1CO9-3014	M30x2 (22L)	7/8X14
1CO9-3017	M30x2 (22L)	1.1/16X12
1CO9-3021	M30x2 (22L)	1.5/16X12
1CO9-3617	M36x2 (28L)	1.1/16X12
1CO9-3621	M36x2 (28L)	1.5/16X12
1CO9-4526	M45x2 (35L)	1.5/8X12

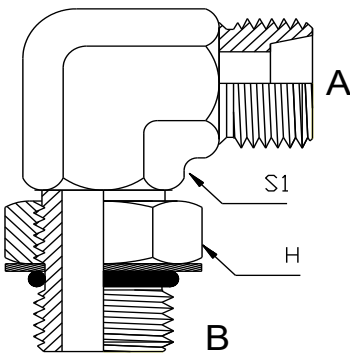
1DO9
DKS Male x UNO Male 90 Elbow

Item No	A-DKS	B-UNO
1DO9-1407	M14x1.5 (06S)	7/16X20
1DO9-1609	M16x1.5 (08S)	9/16X18
1DO9-1809	M18x1.5 (10S)	9/16X18
1DO9-1812	M18x1.5 (10S)	3/4X16
1DO9-2012	M20x1.5 (12S)	3/4X16
1DO9-2414	M24x1.5 (16S)	7/8X14
1DO9-3017	M30x2 (20S)	1.1/16X12
1DO9-3621	M36x2 (25S)	1.5/16X12
1DO9-4226	M42x2 (30S)	1.5/8X12

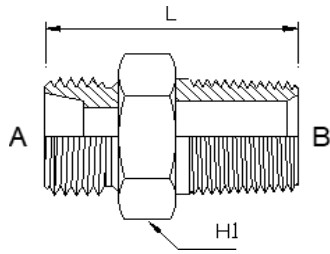
1CT
DKL Male x BSPT Male

Item No	A-DKL	B-BSPT	L	H1
1CT-0802LL	M08x1.0 (04LL)	1/8x28		
1CT-1002LL	M10x1.0 (06LL)	1/8x28		
1CT-1202LL	M12x1.0 (08LL)	1/8x28		
1CT-1202	M12x1.5 (06L)	1/8x28		
1CT-1204	M12x1.5 (06L)	1/4x19		
1CT-1402	M14x1.5 (08L)	1/8x28		
1CT-1404	M14x1.5 (08L)	1/4x19		
1CT-1406	M14x1.5 (08L)	3/8x19		
1CT-1602	M16x1.5 (10L)	1/8x28		
1CT-1604	M16x1.5 (10L)	1/4x19		
1CT-1606	M16x1.5 (10L)	3/8x19		
1CT-1608	M16x1.5 (10L)	1/2x14		
1CT-1804	M18x1.5 (12L)	1/4x19		
1CT-1806	M18x1.5 (12L)	3/8x19		
1CT-1808	M18x1.5 (12L)	1/2x14		
1CT-2206	M22x1.5 (15L)	3/8x19		
1CT-2208	M22x1.5 (15L)	1/2x14		
1CT-2608	M26x1.5 (18L)	1/2x14		
1CT-2612	M26x1.5 (18L)	3/4x14		
1CT-3012	M30x2 (22L)	3/4x14		
1CT-3016	M30x2 (22L)	1x11		
1CT-3616	M36x2 (28L)	1x11		
1CT-3620	M36x2 (28L)	1.1/4x11		
1CT-4520	M45x2 (35L)	1.1/4x11		
1CT-5224	M52x2 (42L)	1.1/2x11		

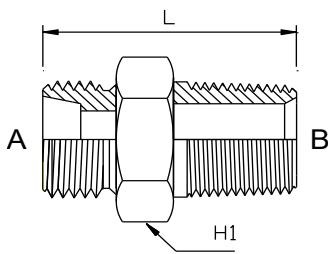
1DT
DKS Male x BSPT Male

Item No	A-DKS	B-BSPT	L	H1
1DT-1404	M14x1.5 (06S)	1/4x19		
1DT-1604	M16x1.5 (08S)	1/4x19		
1DT-1804	M18x1.5 (10S)	1/4x19		
1DT-1806	M18x1.5 (10S)	3/8x19		
1DT-1808	M18x1.5 (10S)	1/2x14		
1DT-2004	M20x1.5 (12S)	1/4x19		
1DT-2006	M20x1.5 (12S)	3/8x19		
1DT-2206	M22x1.5 (14S)	3/8x19		
1DT-2208	M22x1.5 (14S)	1/2x14		
1DT-2406	M24x1.5 (16S)	3/8x19		
1DT-2408	M24x1.5 (16S)	1/2x14		
1DT-3012	M30x2 (20S)	3/4x14		
1DT-3612	M36x2 (25S)	3/4x14		
1DT-3616	M36x2 (25S)	1x11		
1DT-4220	M42x2 (30S)	1.1/4x11		
1DT-5224	M52x2 (38S)	1.1/2x11		

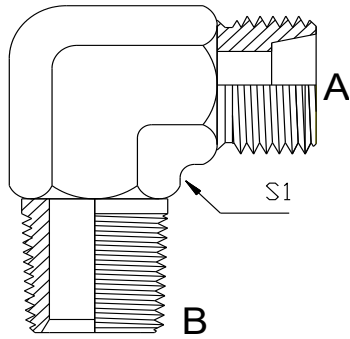
1CT9
DKL Male x BSPT Male 90 Elbow

Item No	A-DKL	B-BSPT	L	H1
1CT9-0802LL	M08x1.0 (04LL)	1/8x28		
1CT9-1002LL	M10x1.0 (06LL)	1/8x28		
1CT9-1202LL	M12x1.0 (08LL)	1/8x28		
1CT9-1202	M12x1.5 (06L)	1/8x28		
1CT9-1204	M12x1.5 (06L)	1/4x19		
1CT9-1404	M14x1.5 (08L)	1/4x19		
1CT9-1604	M16x1.5 (10L)	1/4x19		
1CT9-1606	M16x1.5 (10L)	3/8x19		
1CT9-1608	M16x1.5 (10L)	1/2x14		
1CT9-1804	M18x1.5 (12L)	1/4x19		
1CT9-1806	M18x1.5 (12L)	3/8x19		
1CT9-1808	M18x1.5 (12L)	1/2x14		
1CT9-2206	M22x1.5 (15L)	3/8x19		
1CT9-2208	M22x1.5 (15L)	1/2x14		
1CT9-2212	M22x1.5 (15L)	3/4x14		
1CT9-2608	M26x1.5 (18L)	1/2x14		
1CT9-2612	M26x1.5 (18L)	3/4x14		
1CT9-3012	M30x2 (22L)	3/4x14		
1CT9-3616	M36x2 (28L)	1x11		
1CT9-4520	M45x2 (35L)	1.1/4x11		
1CT9-5224	M52x2 (42L)	1.1/2x11		

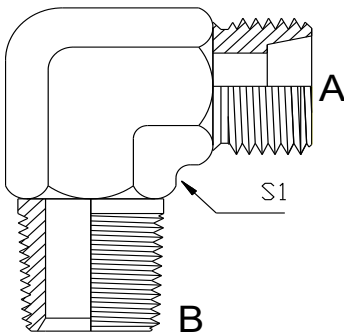
1DT9
DKS Male x BSPT Male 90 Elbow

Item No	A-DKS	B-BSPT	L	H1
1DT9-1404	M14x1.5 (06S)	1/4"x19		
1DT9-1604	M16x1.5 (08S)	1/4"x19		
1DT9-1806	M18x1.5 (10S)	3/8x19		
1DT9-2006	M20x1.5 (12S)	3/8x19		
1DT9-2206	M22x1.5 (14S)	3/8x19		
1DT9-2208	M22x1.5 (14S)	1/2"x14		
1DT9-2406	M24x1.5 (16S)	3/8x19		
1DT9-2408	M24x1.5 (16S)	1/2"x14		
1DT9-3008	M30x2 (20S)	1/2"x14		
1DT9-3012	M30x2 (20S)	3/4x14		
1DT9-3612	M36x2 (25S)	3/4x14		
1DT9-3616	M36x2 (25S)	1"x11		
1DT9-4216	M42x2 (30S)	1"x11		
1DT9-4220	M42x2 (30S)	1.1/4x11		
1DT9-5224	M52x2 (38S)	1.1/2"x11		

1JC
JIC Male x DKL Male

	Item No	A-JIC	B-DKL	L	H1
	1JC-0712	7/16-20	M12x1.5 (06L)		
	1JC-0714	7/16-20	M14x1.5 (08L)		
	1JC-0716	7/16-20	M16x1.5 (10L)		
	1JC-0912	9/16-18	M12x1.5 (06L)		
	1JC-0914	9/16-18	M14x1.5 (08L)		
	1JC-0916	9/16-18	M16x1.5 (10L)		
	1JC-0918	9/16-18	M18x1.5 (12L)		
	1JC-0922	9/16-18	M22x1.5 (15L)		
	1JC-1214	3/4-16	M14x1.5 (08L)		
	1JC-1216	3/4-16	M16x1.5 (10L)		
	1JC-1218	3/4-16	M18x1.5 (12L)		
	1JC-1222	3/4-16	M22x1.5 (15L)		
	1JC-1418	7/8-14	M18x1.5 (12L)		
	1JC-1422	7/8-14	M22x1.5 (15L)		
	1JC-1426	7/8-14	M26x1.5 (18L)		
	1JC-1718	1.1/16-12	M18x1.5 (12L)		
	1JC-1722	1.1/16-12	M22x1.5 (15L)		
	1JC-1726	1.1/16-12	M26x1.5 (18L)		
	1JC-1730	1.1/16-12	M30x2 (22L)		
	1JC-2136	1.5/16-12	M36x2 (28L)		
	1JC-2645	1.5/8-12	M45x2 (35L)		
	1JC-3052	1.7/8-12	M52x2 (42L)		

1JD
JIC Male x DKS Male

	Item No	A-JIC	B-DKS	L	H1
	1JD-0714	7/16-20	M14x1.5 (06S)		
	1JD-0914	9/16-18	M14x1.5 (06S)		
	1JD-0916	9/16-18	M16x1.5 (08S)		
	1JD-0918	9/16-18	M18x1.5 (10S)		
	1JD-0920	9/16-18	M20x1.5 (12S)		
	1JD-0922	9/16-18	M22x1.5 (14S)		
	1JD-1218	3/4-16	M18x1.5 (10S)		
	1JD-1220	3/4-16	M20x1.5 (12S)		
	1JD-1222	3/4-16	M22x1.5 (14S)		
	1JD-1224	3/4-16	M24x1.5 (16S)		
	1JD-1230	3/4-16	M30x2 (20S)		
	1JD-1420	7/8-14	M20x1.5 (12S)		
	1JD-1422	7/8-14	M22x1.5 (14S)	43	
	1JD-1424	7/8-14	M24x1.5 (16S)		
	1JD-1430	7/8-14	M24x1.5 (16S)		
	1JD-1720	1.1/16-12	M20x1.5 (12S)		
	1JD-1722	1.1/16-12	M22x1.5 (14S)		
	1JD-1724	1.1/16-12	M24x1.5 (16S)		
	1JD-1730	1.1/16-12	M30x2 (20S)		
	1JD-1736	1.1/16-12	M36x2 (25S)		
	1JD-2130	1.5/16-12	M30x2 (20S)		
	1JD-2136	1.5/16-12	M36x2 (25S)		
	1JD-2142	1.5/16-12	M42x2 (30S)		
	1JD-2636	1.5/8-12	M36x2 (25S)		
	1JD-2642	1.5/8-12	M42x2 (30S)		
	1JD-2652	1.5/8-12	M42x2 (30S)		
	1JD-3052	1.5/8-12	M42x2 (30S)		

2C
DKL Male x DKOL Female

	Part No	A-DKL	B-DKOL	L	H1
	2C-14	M14x1.5 (08L)	M14x1.5 (08L)		
	2C-16	M16x1.5 (10L)	M16x1.5 (10L)		
	2C-18	M16x1.5 (12L)	M16x1.5 (12L)		
	2C-22	M22x1.5 (15L)	M22x1.5 (15L)		
	2C-26	M26x1.5 (18L)	M26x1.5 (18L)		
	2C-30	M30x2 (22L)	M30x2 (22L)		
	2C-36	M36x2 (28L)	M36x2 (28L)		
	2C-45	M45x2 (35L)	M45x2 (35L)		
	2C-1214	M12x1.5 (06L)	M14x1.5 (08L)		
	2C-1216	M12x1.5 (06L)	M16x1.5 (10L)		
	2C-1218	M12x1.5 (06L)	M18x1.5 (12L)		
	2C-1226	M12x1.5 (06L)	M26x1.5 (18L)		
	2C-1412	M14x1.5 (08L)	M12x1.5 (06L)		
	2C-1416	M14x1.5 (08L)	M16x1.5 (10L)		
	2C-1418	M14x1.5 (08L)	M18x1.5 (12L)		
	2C-1422	M14x1.5 (08L)	M22x1.5 (15L)		
	2C-1426	M14x1.5 (08L)	M26x1.5 (18L)		
	2C-1612	M16x1.5 (10L)	M12x1.5 (06L)		
	2C-1614	M16x1.5 (10L)	M14x1.5 (08L)		
	2C-1618	M16x1.5 (10L)	M18x1.5 (12L)		
	2C-1622	M16x1.5 (10L)	M22x1.5 (15L)		
	2C-1626	M16x1.5 (10L)	M26x1.5 (18L)		
	2C-1630	M16x1.5 (10L)	M30x2 (22L)		
	2C-1822	M18x1.5 (12L)	M22x1.5 (15L)		
	2C-1826	M18x1.5 (12L)	M26x1.5 (18L)		
	2C-1830	M18x1.5 (12L)	M30x2 (22L)		
	2C-1836	M18x1.5 (12L)	M36x2 (28L)		
	2C-2216	M22x1.5 (15L)	M16x1.5 (10L)		
	2C-2226	M22x1.5 (15L)	M26x1.5 (18L)		
	2C-2230	M22x1.5 (15L)	M30x2 (22L)		
	2C-2236	M22x1.5 (15L)	M36x2 (28L)		
	2C-2245	M22x1.5 (15L)	M45x2 (35L)		
	2C-2630	M26x1.5 (18L)	M30x2 (22L)		
	2C-2636	M26x1.5 (18L)	M36x2 (28L)		
	2C-2645	M26x1.5 (18L)	M45x2 (35L)		
	2C-2652	M26x1.5 (18L)	M52x2 (42L)		
	2C-3036	M30x2 (22L)	M36x2 (28L)		
	2C-3045	M30x2 (22L)	M45x2 (35L)		
	2C-3052	M30x2 (22L)	M52x2 (42L)		
	2C-3645	M36x2 (28L)	M45x2 (35L)		
	2C-3652	M36x2 (28L)	M52x2 (42L)		
	2C-4552	M45x2 (35L)	M52x2 (42L)		
	2C-5245	M52x2 (42L)	M45x2 (35L)		

2D
DKS Male x DKOS Female

	Item No	A-DKS	A-DKOS	L	H1
	2D-1416	M14x1.5 (06S)	M16x1.5 (08S)		
	2D-1418	M14x1.5 (06S)	M18x1.5 (10S)		
	2D-1420	M14x1.5 (06S)	M20x1.5 (12S)		
	2D-1422	M14x1.5 (06S)	M22x1.5 (14S)		
	2D-1618	M16x1.5 (08S)	M18x1.5 (10S)		
	2D-1620	M16x1.5 (08S)	M20x1.5 (12S)		
	2D-1622	M16x1.5 (08S)	M22x1.5 (14S)		
	2D-1624	M16x1.5 (08S)	M24x1.5 (16S)		
	2D-1630	M16x1.5 (08S)	M30x2 (20S)		
	2D-1820	M18x1.5 (10S)	M20x1.5 (12S)		
	2D-1822	M18x1.5 (10S)	M22x1.5 (14S)		
	2D-1824	M18x1.5 (10S)	M24x1.5 (16S)		
	2D-1830	M18x1.5 (10S)	M30x2 (20S)		
	2D-2022	M20x1.5 (12S)	M22x1.5 (14S)		
	2D-2024	M20x1.5 (12S)	M24x1.5 (16S)		
	2D-2030	M20x1.5 (12S)	M30x2 (20S)		
	2D-2042	M20x1.5 (12S)	M42x2 (30S)		
	2D-22	M22x1.5 (14S)	M22x1.5 (14S)		
	2D-2224	M22x1.5 (14S)	M24x1.5 (16S)		
	2D-2230	M22x1.5 (14S)	M30x2 (20S)		
	2D-2236	M22x1.5 (14S)	M36x2 (25S)		
	2D-2242	M22x1.5 (14S)	M42x2 (30S)		
	2D-2430	M24x1.5 (16S)	M30x2 (20S)		
	2D-2436	M24x1.5 (16S)	M36x2 (25S)		
	2D-2442	M24x1.5 (16S)	M42x2 (30S)		
	2D-2452	M24x1.5 (16S)	M52x2 (38S)		
	2D-3036	M30x2 (20S)	M36x2 (25S)		
	2D-3042	M30x2 (20S)	M42x2 (30S)		
	2D-3642	M36x2 (25S)	M42x2 (30S)		
	2D-3052	M30x2 (20S)	M52x2 (38S)		
	2D-3652	M36x2 (25S)	M52x2 (38S)		
	2D-4252	M42x2 (30S)	M52x2 (38S)		

2C9
DKL Male x DKOL Female 90 Elbow

	Part No	A-DKL	B-DKOL	L	H1
	2C9-12	M12x1.5 (06L)	M12x1.5 (06L)		
	2C9-14	M14x1.5 (08L)	M14x1.5 (08L)		
	2C9-16	M16x1.5 (10L)	M16x1.5 (10L)		
	2C9-18	M18x1.5 (12L)	M18x1.5 (12L)		
	2C9-22	M22x1.5 (15L)	M22x1.5 (15L)		
	2C9-26	M26x1.5 (18L)	M26x1.5 (18L)		
	2C9-30	M30x2 (22L)	M30x2 (22L)		
	2C9-36	M36x2 (28L)	M36x2 (28L)		
	2C9-45	M45x2 (35L)	M45x2 (35L)		
	2C9-52	M52x2 (42L)	M52x2 (42L)		

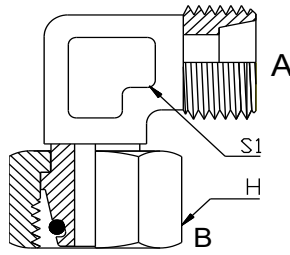
2D9
DKS Male x DKOS Female 90 Elbow

Item No	A-DKS	A-DKOS	L	H1
2D9-14	M14x1.5 (06S)	M14x1.5 (06S)		
2D9-16	M16x1.5 (08S)	M16x1.5 (08S)		
2D9-18	M18x1.5 (10S)	M18x1.5 (10S)		
2D9-20	M20x1.5 (12S)	M20x1.5 (12S)		
2D9-22	M22x1.5 (14S)	M22x1.5 (14S)		
2D9-24	M24x1.5 (16S)	M24x1.5 (16S)		
2D9-30	M30x2 (20S)	M30x2 (20S)		
2D9-36	M36x2 (25S)	M36x2 (25S)		
2D9-42	M42x2 (30S)	M42x2 (30S)		
2D9-52	M52x2 (38S)	M52x2 (38S)		

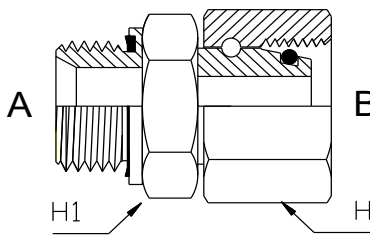
2GC
BSPF Male (ES) x DKOL Female

Part No	A-BSPF	B-DKOL	L	H1
2GC-0212	-02 1/8-28	M14x1.5 (08L)		
2GC-0414	-04 1/4-19	M14x1.5 (08L)		
2GC-0416	-04 1/4-19	M16x1.5 (10L)		
2GC-0418	-04 1/4-19	M18x1.5 (12L)		
2GC-0616	-06 3/8-19	M16x1.5 (10L)		
2GC-0618	-06 3/8-19	M18x1.5 (12L)		
2GC-0622	-06 3/8-19	M22x1.5 (15L)		
2GC-0818	-08 1/2-14	M18x1.5 (12L)		
2GC-0822	-08 1/2-14	M22x1.5 (15L)		
2GC-0826	-08 1/2-14	M26x1.5 (18L)		
2GC-1226	-12 3/4-14	M26x1.5 (18L)		
2GC-1230	-12 3/4-14	M30x2 (22L)		
2GC-1236	-12 3/4-14	M36x2 (28L)		
2GC-1636	-16 1-11	M36x2 (28L)		
2GC-2045	-20 1.1/4-11	M45x2 (35L)		
2GC-2452	-24 1.1/2-11	M52x2 (42L)		

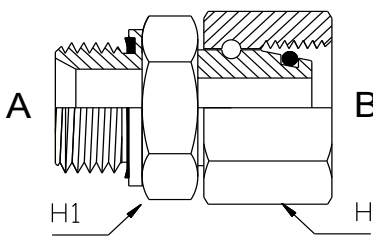
2GD
BSPF Male (ES) x DKOS Female

Part No	A-BSPF	B-DKOS	H1	H
2GD-0414	-04 1/4-19	M14x1.5 (06S)	19	17
2GD-0416	-04 1/4-19	M16x1.5 (08S)	19	19
2GD-0418	-04 1/4-19	M18x1.5 (10S)		
2GD-0420	-04 1/4-19	M20x1.5 (12S)		
2GD-0618	-06 3/8-19	M18x1.5 (10S)	22	22
2GD-0620	-06 3/8-19	M20x1.5 (12S)	22	24
2GD-0820	-08 1/2-14	M20x1.5 (12S)		
2GD-0822	-08 1/2-14	M22x1.5 (14S)	27	27
2GD-0824	-08 1/2-14	M24x1.5 (16S)	27	30
2GD-0830	-08 1/2-14	M30x2 (20S)	27	36
2GD-1230	-12 3/4-14	M30x2 (20S)	32	36
2GD-1236	-12 3/4-14	M36x2 (25S)		
2GD-1636	-16 1-11	M36x2 (25S)	41	46
2GD-2042	-20 1.1/4-11	M42x2 (30S)	50	50
2GD-2452	-24 1.1/2-11	M52x2 (38S)		

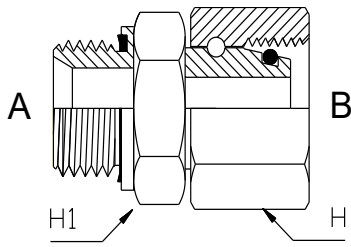
2MC
Metric Male (ES) x DKOL Female

Part No	A-METRIC	B-DKOL	L	H1
2MC-1416	-14 M14x1.5	M14x1.5 (08L)		
2MC-1822	-18 M18x1.5	M14x1.5 (08L)		
2MC-2218	-22 M22x1.5	M16x1.5 (10L)		

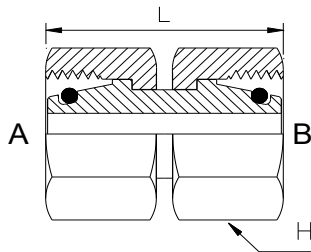
3C
DKOL Female x DKOL Female

Part No	A-DKOL	B-DKOL	L	H1
3C-12	M12x1.5 (06L)	M12x1.5 (06L)		
3C-14	M14x1.5 (08L)	M14x1.5 (08L)		
3C-16	M16x1.5 (10L)	M16x1.5 (10L)		
3C-1614	M16x1.5 (10L)	M14x1.5 (08L)		
3C-18	M18x1.5 (12L)	M18x1.5 (12L)		
3C-1814	M18x1.5 (12L)	M14x1.5 (08L)		
3C-22	M22x1.5 (15L)	M22x1.5 (15L)		
3C-2622	M26x1.5 (18L)	M22x1.5 (15L)		
3C-26	M26x1.5 (18L)	M26x1.5 (18L)		
3C-30	M30x2 (22L)	M30x2 (22L)		
3C-36	M36x2 (28L)	M36x2 (28L)		
3C-45	M45x2 (35L)	M45x2 (35L)		
3C-52	M52x2 (42L)	M52x2 (42L)		

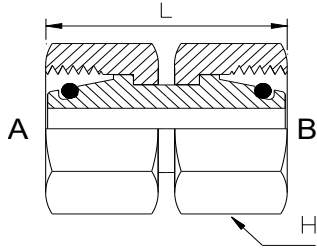
3D
DKOS Female x DKOS Female

Item No	A-DKS	A-DKOS	L	H1
3D-14	M14x1.5 (06S)	M14x1.5 (06S)		
3D-16	M16x1.5 (08S)	M16x1.5 (08S)		
3D-18	M18x1.5 (10S)	M18x1.5 (10S)		
3D-20	M20x1.5 (12S)	M20x1.5 (12S)		
3D-22	M22x1.5 (14S)	M22x1.5 (14S)		
3D-24	M24x1.5 (16S)	M24x1.5 (16S)		
3D-30	M30x2 (20S)	M30x2 (20S)		
3D-36	M36x2 (25S)	M36x2 (25S)		
3D-42	M42x2 (30S)	M42x2 (30S)		
3D-52	M52x2 (38S)	M52x2 (38S)		

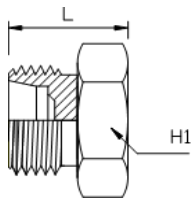
4C
DKL Male Plug

Part No	A-DKL	L	H1
4C-12	M12x1.5 (06L)		
4C-14	M14x1.5 (08L)		
4C-16	M16x1.5 (10L)		
4C-18	M18x1.5 (12L)		
4C-22	M22x1.5 (15L)		
4C-26	M26x1.5 (18L)		
4C-30	M30x2 (22L)		
4C-36	M36x2 (28L)		
4C-45	M45x2 (35L)		
4C-52	M52x2 (42L)		

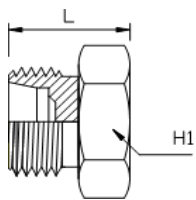
4D
DKS Male Plug

Part No	A-DKS	L	H1
4D-14	M14x1.5 (06S)		
4D-16	M16x1.5 (08S)		
4D-18	M18x1.5 (10S)		
4D-20	M20x1.5 (12S)		
4D-22	M22x1.5 (14S)		
4D-24	M24x1.5 (16S)		
4D-30	M30x2 (20S)		
4D-36	M36x2 (25S)		
4D-42	M42x2 (30S)		
4D-52	M52x2 (38S)		

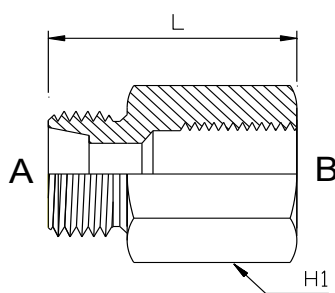
5CB
DKL Male BSPP Fixed Female

Part No	A-DKL	B-BSPP	L	H1
5CB-1202	M12x1.5 (06L)	-02 1/8-28		
5CB-1404	M14x1.5 (08L)	-04 1/4-19		
5CB-1604	M16x1.5 (10L)	-04 1/4-19		
5CB-1806	M18x1.5 (12L)	-06 3/8-19		
5CB-2208	M22x1.5 (15L)	-08 1/2-14		
5CB-2608	M26x1.5 (18L)	-08 1/2-14		
5CB-3012	M30x2 (22L)	-12 3/4-14		
5CB-3616	M36x2 (28L)	-16 1-11		
5CB-4520	M45x2 (35L)	-20 1.1/4-11		

5DB
DKS Male BSPP Fixed Female

Part No	A-DKS	B-BSPP	L	H1
5DB-1806	M18x1.5 (10S)	-06 3/8-19		
5DB-4220	M42x2 (30S)	-20 1.1/4-11		

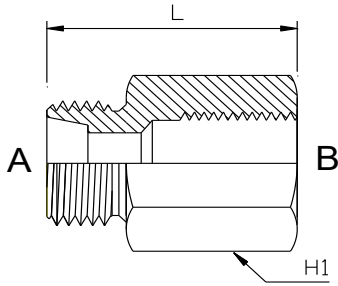

6C
DKL Male x DKL Male Bulkhead

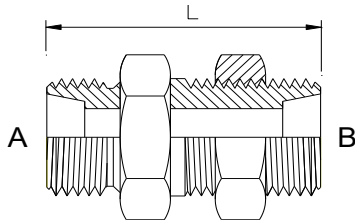
Part No	A-DKL	B-DKL	L	H1
6C-12	M12x1.5 (06L)	M12x1.5 (06L)		
6C-14	M14x1.5 (08L)	M14x1.5 (08L)		
6C-16	M16x1.5 (10L)	M16x1.5 (10L)		
6C-18	M18x1.5 (12L)	M18x1.5 (12L)		
6C-22	M22x1.5 (15L)	M22x1.5 (15L)		
6C-26	M26x1.5 (18L)	M26x1.5 (18L)		
6C-30	M30x2 (22L)	M30x2 (22L)		
6C-36	M36x2 (28L)	M36x2 (28L)		
6C-45	M45x2 (35L)	M45x2 (35L)		
6C-52	M52x2 (42L)	M52x2 (42L)		

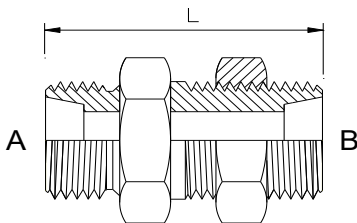

6D
DKS Male x DKS Male Bulkhead

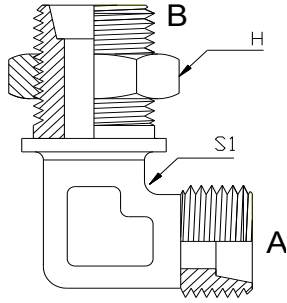
Part No	A-DKS	B-DKS	L	H1
6D-14	M14x1.5 (06S)	M14x1.5 (06S)		
6D-16	M16x1.5 (08S)	M16x1.5 (08S)		
6D-18	M18x1.5 (10S)	M18x1.5 (10S)		
6D-20	M20x1.5 (12S)	M20x1.5 (12S)		
6D-22	M22x1.5 (14S)	M22x1.5 (14S)		
6D-24	M24x1.5 (16S)	M24x1.5 (16S)		
6D-30	M30x2 (20S)	M30x2 (20S)		
6D-36	M36x2 (25S)	M36x2 (25S)		
6D-42	M42x2 (30S)	M42x2 (30S)		
6D-52	M52x2 (38S)	M52x2 (38S)		

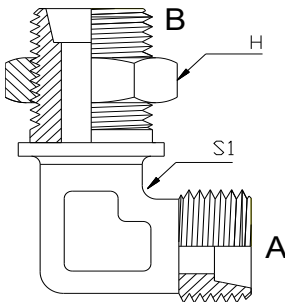

6C9
DKL Male x DKL Male Bulkhead 90 Elbow

Part No	A-DKL	B-DKL	H
6C9-12	M12x1.5 (06L)	M12x1.5 (06L)	
6C9-14	M14x1.5 (08L)	M14x1.5 (08L)	
6C9-16	M16x1.5 (10L)	M16x1.5 (10L)	
6C9-18	M18x1.5 (12L)	M18x1.5 (12L)	
6C9-22	M22x1.5 (15L)	M22x1.5 (15L)	
6C9-26	M26x1.5 (18L)	M26x1.5 (18L)	
6C9-30	M30x2 (22L)	M30x2 (22L)	
6C9-36	M36x2 (28L)	M36x2 (28L)	
6C9-45	M45x2 (35L)	M45x2 (35L)	
6C9-52	M52x2 (42L)	M52x2 (42L)	

6D9
DKS Male x DKS Male Bulkhead 90 Elbow

Part No	A-DKS	B-DKS	H
6D9-14	M14x1.5 (06S)	M14x1.5 (06S)	
6D9-16	M16x1.5 (08S)	M16x1.5 (08S)	
6D9-18	M18x1.5 (10S)	M18x1.5 (10S)	
6D9-20	M20x1.5 (12S)	M20x1.5 (12S)	
6D9-22	M22x1.5 (14S)	M22x1.5 (14S)	
6D9-24	M24x1.5 (16S)	M24x1.5 (16S)	
6D9-30	M30x2 (20S)	M30x2 (20S)	
6D9-36	M36x2 (25S)	M36x2 (25S)	
6D9-42	M42x2 (30S)	M42x2 (30S)	
6D9-52	M52x2 (38S)	M52x2 (38S)	

9C
DKOL Cap

Part No	A-DKOL	Insert P/N	H
9C-12	M12x1.5 (06L)	9C-12-A	14
9C-14	M14x1.5 (08L)	9C-14-A	17
9C-16	M16x1.5 (10L)	9C-16-A	19
9C-18	M18x1.5 (12L)	9C-18-A	22
9C-22	M22x1.5 (15L)	9C-22-A	27
9C-26	M26x1.5 (18L)	9C-26-A	32
9C-30	M30x2 (22L)	9C-30-A	36
9C-36	M36x2 (28L)	9C-36-A	41
9C-45	M45x2 (35L)	9C-45-A	50
9C-52	M52x2 (42L)	9C-52-A	60

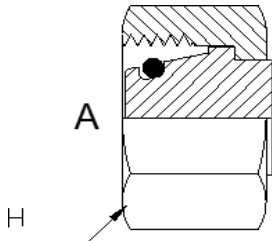

* Use Insert P/N to order without nut

9D
DKOS Cap

Part No	A-DKOS	Insert P/N	H1
9D-14	M14x1.5 (06S)	9C-12-A	17
9D-16	M16x1.5 (08S)	9C-14-A	19
9D-18	M18x1.5 (10S)	9C-16-A	22
9D-20	M20x1.5 (12S)	9C-18-A	24
9D-22		9D-22-A	27
9D-24	M24x1.5 (16S)	9D-24-A	30
9D-30	M30x2 (20S)	9D-30-A	36
9D-36	M36x2 (25S)	9D-36-A	46
9D-42	M42x2 (30S)	9D-42-A	50
9D-52	M52x2 (38S)	9D-52-A	60

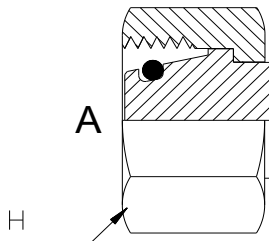

* Use Insert P/N to order without nut

GE
DKLL Male x METRIC Tapered Male

Item No	A-DKLL	B-M Tapered	L	H1
GE-6LLMK6X1	M10x1.0 (06LL)	M06x1.0 Tapered		
GE-6LLMK8X1	M10x1.0 (T06LL)	M08x1.0 Tapered		

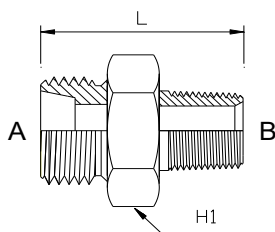

WE
DKLL Male x METRIC Tapered Male 90 Elbow

Item No	A-DKLL	B-M Tapered	L	H1
WE-6LLMK6X1	M10x1.0 (06LL)	M06x1.0 Tapered		
WE-6LLMK8X1	M10x1.0 (06LL)	M08x1.0 Tapered		

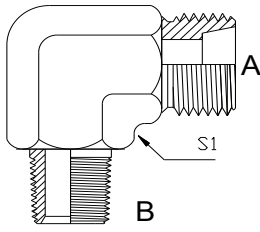
A1C
DKL Male Tee

Part No	A-DKL	B-DKL	C-DKL	S1
A1C-12	M12x1.5 (06L)	M12x1.5 (06L)	M12x1.5 (06L)	
A1C-14	M14x1.5 (08L)	M14x1.5 (08L)	M14x1.5 (08L)	
A1C-16	M16x1.5 (10L)	M16x1.5 (10L)	M16x1.5 (10L)	
A1C-18	M18x1.5 (12L)	M18x1.5 (12L)	M18x1.5 (12L)	
A1C-22	M22x1.5 (15L)	M22x1.5 (15L)	M22x1.5 (15L)	
A1C-26	M26x1.5 (18L)	M26x1.5 (18L)	M26x1.5 (18L)	
A1C-30	M30x2 (22L)	M30x2 (22L)	M30x2 (22L)	
A1C-36	M36x2 (28L)	M36x2 (28L)	M36x2 (28L)	
A1C-45	M45x2 (35L)	M45x2 (35L)	M45x2 (35L)	
A1C-52	M52x2 (42L)	M52x2 (42L)	M52x2 (42L)	

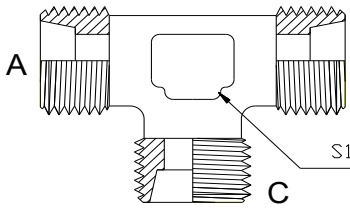
A1D
DKS Male Tee

Part No	A-DKS	B-DKS	C-DKS	S1
A1D-14	M14x1.5 (06S)	M14x1.5 (06S)	M14x1.5 (06S)	
A1D-16	M16x1.5 (08S)	M16x1.5 (08S)	M16x1.5 (08S)	
A1D-18	M18x1.5 (10S)	M18x1.5 (10S)	M18x1.5 (10S)	
A1D-20	M20x1.5 (12S)	M20x1.5 (12S)	M20x1.5 (12S)	
A1D-22	M22x1.5 (14S)	M22x1.5 (14S)	M22x1.5 (14S)	
A1D-24	M24x1.5 (16S)	M24x1.5 (16S)	M24x1.5 (16S)	
A1D-30	M30x2 (20S)	M30x2 (20S)	M30x2 (20S)	
A1D-36	M36x2 (25S)	M36x2 (25S)	M36x2 (25S)	
A1D-42	M42x2 (30S)	M42x2 (30S)	M42x2 (30S)	
A1D-52	M52x2 (38S)	M52x2 (38S)	M52x2 (38S)	

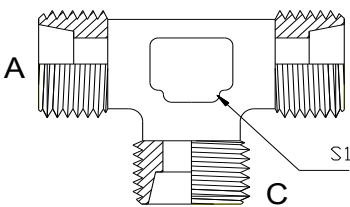

A2C
DKL Male Male Female (Drop) Tee

	Part No	A-DKL	B-DKL	C-DKOL	S1
	A2C-12	M12x1.5 (06L)	M12x1.5 (06L)	M12x1.5 (06L)	
	A2C-14	M14x1.5 (08L)	M14x1.5 (08L)	M14x1.5 (08L)	
	A2C-16	M16x1.5 (10L)	M16x1.5 (10L)	M16x1.5 (10L)	
	A2C-18	M18x1.5 (12L)	M18x1.5 (12L)	M18x1.5 (12L)	
	A2C-22	M22x1.5 (15L)	M22x1.5 (15L)	M22x1.5 (15L)	
	A2C-26	M26x1.5 (18L)	M26x1.5 (18L)	M26x1.5 (18L)	
	A2C-30	M30x2 (22L)	M30x2 (22L)	M30x2 (22L)	
	A2C-36	M36x2 (28L)	M36x2 (28L)	M36x2 (28L)	
	A2C-45	M45x2 (35L)	M45x2 (35L)	M45x2 (35L)	
	A2C-52	M52x2 (42L)	M52x2 (42L)	M52x2 (42L)	

A2D
DKS Male Male Female (Drop) Tee

	Part No	A-DKS	B-DKS	C-DKOS	S1
	A2D-14	M14x1.5 (06S)	M14x1.5 (06S)	M14x1.5 (06S)	
	A2D-16	M16x1.5 (08S)	M16x1.5 (08S)	M16x1.5 (08S)	
	A2D-18	M18x1.5 (10S)	M18x1.5 (10S)	M18x1.5 (10S)	
	A2D-20	M20x1.5 (12S)	M20x1.5 (12S)	M20x1.5 (12S)	
	A2D-22	M22x1.5 (14S)	M22x1.5 (14S)	M22x1.5 (14S)	
	A2D-24	M24x1.5 (16S)	M24x1.5 (16S)	M24x1.5 (16S)	
	A2D-30	M30x2 (20S)	M30x2 (20S)	M30x2 (20S)	
	A2D-36	M36x2 (25S)	M36x2 (25S)	M36x2 (25S)	
	A2D-42	M42x2 (30S)	M42x2 (30S)	M42x2 (30S)	
	A2D-52	M52x2 (38S)	M52x2 (38S)	M52x2 (38S)	

A3C
DKL Male Male Female (Run) Tee

	Part No	A-DKL	B-DKL	C-DKOL	S1
	A3C-12	M12x1.5 (06L)	M12x1.5 (06L)	M12x1.5 (06L)	
	A3C-14	M14x1.5 (08L)	M14x1.5 (08L)	M14x1.5 (08L)	
	A3C-16	M16x1.5 (10L)	M16x1.5 (10L)	M16x1.5 (10L)	
	A3C-18	M18x1.5 (12L)	M18x1.5 (12L)	M18x1.5 (12L)	
	A3C-22	M22x1.5 (15L)	M22x1.5 (15L)	M22x1.5 (15L)	
	A3C-26	M26x1.5 (18L)	M26x1.5 (18L)	M26x1.5 (18L)	
	A3C-30	M30x2 (22L)	M30x2 (22L)	M30x2 (22L)	
	A3C-36	M36x2 (28L)	M36x2 (28L)	M36x2 (28L)	
	A3C-45	M45x2 (35L)	M45x2 (35L)	M45x2 (35L)	
	A3C-52	M52x2 (42L)	M52x2 (42L)	M52x2 (42L)	

A3D
DKS Male Male Female (Run) Tee

	Part No	A-DKS	B-DKS	C-DKOS	S1
	A3D-14	M14x1.5 (06S)	M14x1.5 (06S)	M14x1.5 (06S)	
	A3D-16	M16x1.5 (08S)	M16x1.5 (08S)	M16x1.5 (08S)	
	A3D-18	M18x1.5 (10S)	M18x1.5 (10S)	M18x1.5 (10S)	
	A3D-20	M20x1.5 (12S)	M20x1.5 (12S)	M20x1.5 (12S)	
	A3D-22	M22x1.5 (14S)	M22x1.5 (14S)	M22x1.5 (14S)	
	A3D-24	M24x1.5 (16S)	M24x1.5 (16S)	M24x1.5 (16S)	
	A3D-30	M30x2 (20S)	M30x2 (20S)	M30x2 (20S)	
	A3D-36	M36x2 (25S)	M36x2 (25S)	M36x2 (25S)	
	A3D-42	M42x2 (30S)	M42x2 (30S)	M42x2 (30S)	
	A3D-52	M52x2 (38S)	M52x2 (38S)	M52x2 (38S)	

PART NUMBERS EXPLAINED

Part Number Structure

The structure of the part numbering is:-

- Fitting Type
- End Style
- Special Suffix (where applicable)
- Connection Size (dash size)

Part Number Examples

Two common part numbers are broken down into their components in the examples below.

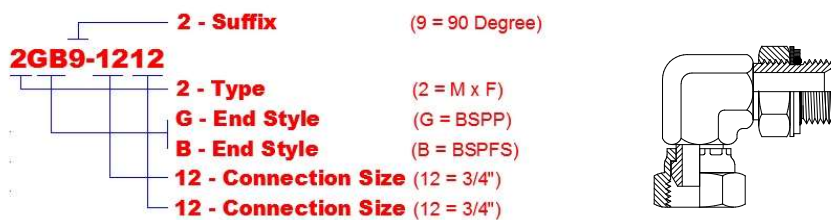

Details and listings of the Fitting Class, End Styles and Configurations are in the following pages.

Dash Sizes

The Dash Size is the size of the connection or hose:-

- expressed in "sixteenths" of an inch for imperial measurements
- expressed in "millimeters" for metric sizes

Eg:- 1/2"	-08 (8 sixteenths of an inch)
3/8"	-06 (6 sixteenths of an inch)
24mm	-24 (24mm)

Fitting Type

The "Fitting Types" are grouped as follows:-

1	Male x Male
2	Male x Female Swivel
4	Male Plug, Weld-On, Reducing Bush
5	Male x Fixed Female
6	Bulkhead
7	Fixed Female x Fixed Female
8	Nut
9	Caps, Female Weld-On
A	Tee
Z	Cross

End Styles

B	BSPP Female Swivel/BSPP Male Bonded Seal Type
C	Metric DKL
D	Metric DKS
E	Metric O-ring Flat Face
F	O-ring Flat Face - UN thread
FL	SAE Flange Code 61
FLH	SAE Flange Code 62
G	BSPP Male (Straight is Encapsulated Seal, Elbows Adjustable)
I	Banjo
J	JIC (74 degree seat UNF)
K	JIS Metric (Komatsu Metric)
M	Metric Male
N	NPT
O	UNO Ring
P	SAE (45 Degree)
PI	SAE Inverted Flare
Q	74 Degree seat Metric Thread
S	JIS (BSPP thread x 60 deg seat)
T	BSPT
U	NPSM Female Swivel

Suffixes

L	Long (Extended)
R	Reducing Bush
T	Tube Type Fitting
W	Weld-On
X	Male Swivel
GSP	Pressure Gauge Fitting

Description Terminology

Short Form	Connection Type
BBJ	Banjo
BBM	British Standard Pipe Parallel Bulkhead Male
BBN	Bulkhead Nut BSPP
BJF	JIS (BSP) 60 Degree Seat Female
BJM	JIS (BSP) 60 Degree Seat Male
BPF	British Standard Pipe Parallel Fixed Female
BPM	British Standard Pipe Parallel Male
BSF	British Standard Pipe Female Swivel
BTF	British Standard Pipe Taper Female (Non Swivel)
BTM	British Standard Pipe Taper Male
CAT	Cat Flange
CL	SAE Solid Flange Clamp
CLS	SAE Split Flange Clamp
CROSS	Cross - Four Connections
CS	Hexagonal - Counter Sunk
DSB	Bonded (Dowty) Seal BSP
DSM	Bonded (Dowty) Seal Metric
EDB	Encapsulated Seal BSP
EDM	Encapsulated Seal Metric
F61	SAE Flange Code 61
F61B	SAE Flange Code 61 Blanking Cap
F62	SAE Flange Code 62
F62B	SAE Flange Code 62 Blanking Cap
GAUGE	Gauge Adaptor BSPP
JBM	JIC (Joint Industrial Council) Female Swivel
JBN	Bulkhead Nut JIC
JFF	JIC (Joint Industrial Council) Female Fixed
JIF	JIC (Joint Industrial Council) Female Swivel
JIM	JIC (Joint Industrial Council) Male
JTN	JIC (Joint Industrial Council) Tube Nut
JTN+JTS	JIC (Joint Industrial Council) Tube Nut + Sleeve
JTS	JIC (Joint Industrial Council) Tube Sleeve
MCF	Flat Face Chinese Metric Female
MCM	Flat Face Chinese Metric Male
MHF	DIN DKS Compression (Heavy) Female
MHM	DIN DKS Compression (Heavy) Male
MJM	Metric Male Chinese 37 Degree Seat
MKF	JIS (Komatsu) 60 Degree Seat Metric Female
MKM	JIS (Komatsu) 60 Degree Seat Metric Male
MLF	DIN DKL Compression (Light) Female
MLM	DIN DKL Compression (Light) Male
MSM	Metric Stud Male
NSF	NPSM National Pipe Straight Mechanical Female Swivel

Continued

Continued

Short Form Connection Type

NTF	NPT National Pipe Taper Female (Non Swivel)
NTM	NPT National Pipe Taper Male
OBM	ORFS Bulkhead Male
OBN	SAE O-Ring Flat Face Bulkhead Nut
OR	O-Ring
ORF	ORFS SAE O-Ring Flat Face Female
ORM	ORFS SAE O-Ring Flat Face Male
ORW	O-Ring / Retaining Ring BSPP
OTN	SAE O-Ring Flat Face Nut
SAF	SAE 45 Degree Seal Female
SAM	SAE 45 Degree Seat Male
TWF	Tube Weld-On
UNF	UNO Female
UNM	UNO Male
UNX	UNO Male Swivel

Description Sequence

The description will always follow the same sequence as the part number.

For example:-

1JG9-1206

JICM BSPPM 90 Elbow

2TB-0808

BSPTM BSPPFS Nipple

Not also that the Part Number, Dash Sizes and Description are always in the same sequence

TEES - The sequence is always RUN / RUN / BRANCH (A - B - C)

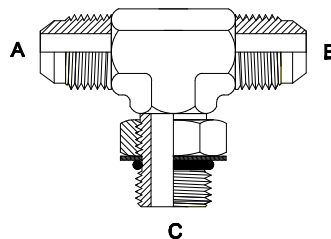

PART NUMBER INDEX

AYRTEC Item No	Short Description	Catalogue Page No	Visual Index Section
1B	BSPP Male x BSPP Male	1	Straight MxM
1BFL	BSPP Male x SAE Cd 61 Flange	3	Straight MxM
1BFLH	BSPP Male x SAE Cd 62 Flange	3	Straight MxM
1BG9	BSPP Male x BSPP Male 90 Elbow	74	90 Degree
1BM	BSPP Male x Metric Stud Male	2	Straight MxM
1BO	BSPP Male x UNO Male	3	Straight MxM
1C	DKL Male x DKL Male	121	Straight MxM
1C9	DKL Male x DKL Male 90 Elbow	122	90 Degree
1CG	DKL Male x BSPP Male Encapsulated Seal	123	Straight MxM
1CG9	DKL Male x BSPP Male 90 Elbow	124	90 Degree
1CI	DKOL METRIC BANJO ADAPTOR	125	90 Degree
1CM	DKL Male x Metric Male ES	126	Straight MxM
1CN	DKL Male x NPT Male	127	Straight MxM
1CN9	DKL Male x NPT Male 90 Elbow	128	90 Degree
1CO	DKL Male x UNO Male	129	Straight MxM
1CO9	DKL Male x UNO Male 90 Elbow	130	90 Degree
1CT	DKL Male x BSPT Male	131	Straight MxM
1CT9	DKL Male x BSPT Male 90 Elbow	132	90 Degree
1D	DKS Male x DKS Male Adaptor	122	Straight MxM
1D9	DKS Male x DKS Male 90 Elbow	123	90 Degree
1D9	DKS Male x DKS Male 90 Elbow	123	90 Degree
1DG	DKS Male x BSPP Male Encapsulated Seal	124	Straight MxM
1DG9	DKS Male x BSPP Male 90 Elbow	125	90 Degree
1DM	DKS Male x Metric Male ES	127	Straight MxM
1DN	DKS Male x NPT Male	128	Straight MxM
1DN9	DKS Male x NPT Male 90 Elbow	128	90 Degree
1DO	DKS Male x UNO Male	129	Straight MxM
1DO9	DKS Male x UNO Male 90 Elbow	130	90 Degree
1DT	DKS Male x BSPT Male	131	Straight MxM
1DT9	DKS Male x BSPT Male 90 Elbow	132	90 Degree
1E	METRIC Flat Face Male x METRIC Flat Face Male	4	Straight MxM
1ET	METRIC Flat Face Male x BSPT Male	4	Straight MxM
1F	ORFS Male x ORFS Male	4	Straight MxM
1F9	ORFS Male x ORFS Male 90 Elbow	74	90 Degree
1FG	ORFS Male x BSPP Male Encapsulated Seal Type	5	Straight MxM
1FG*R	ORFS Male x BSPP Male O-Ring + Retaining Ring Type	5	Straight MxM
1FG4	ORFS Male x BSPP Male 45 Elbow	62	45 Degree

AYRTEC Item No	Short Description	Catalogue Page No	Visual Index Section
1FG9	ORFS Male x BSPP Male 90 Elbow	74	90 Degree
1FM	ORFS Male x METRIC Male	5	Straight MxM
1FN	ORFS Male x NPT Male	6	Straight MxM
1FN4	ORFS Male x NPT Male 45 Elbow	62	45 Degree
1FN9	ORFS Male x NPT Male 90 Elbow	75	90 Degree
1FO	ORFS Male x UNO Male	6	Straight MxM
1FO4	ORFS Male x UNO Male 45 Elbow	62	45 Degree
1FO9	ORFS Male x UNO Male 90 Elbow	75	90 Degree
1FT	ORFS Male x BSPT Male	7	Straight MxM
1G	BSPP Male x BSPP Male	1	Straight MxM
1G*R	BSPP Male x BSPP Male	2	Straight MxM
1GG9	BSPP Male x BSPP Male 90 Elbow	76	90 Degree
1GO9	BSPP Male x UNO Male 90 Elbow	76	90 Degree
1J	JIC Male x JIC Male	7	Straight MxM
1J4	JIC Male x JIC Male 45 Elbow	63	45 Degree
1J9	JIC Male x JIC Male 90 Elbow	77	90 Degree
1JC	JIC Male x DKL Male	133	Straight MxM
1JD	JIC Male x DKS Male	133	Straight MxM
1JE	JIC Male x METRIC Flat Face Male	8	Straight MxM
1JF	JIC Male x ORFS Male	8	Straight MxM
1JFL	JIC Male x SAE Cd 61 Flange	8	SAE Flange
1JFL4	JIC Male x SAE Cd 61 Flange 45 Swept Bend	63	SAE Flange
1JFL4C	JIC Male x SAE Cd 61 Flange 45 Elbow	64	SAE Flange
1JFL9	JIC Male x SAE Cd 61 Flange 90 Swept Bend	77	SAE Flange
1JFL9C	JIC Male x SAE Cd 61 Flange 90 Elbow	77	SAE Flange
1JFLH	JIC Male x SAE Cd 62 Flange	9	SAE Flange
1JFLH4	JIC Male x SAE Cd 62 Flange 45 Swept Bend	63	SAE Flange
1JFLH4C	JIC Male x SAE Cd 62 Flange 45 Elbow	64	SAE Flange
1JFLH9	JIC Male x SAE Cd 62 Flange 90 Swept Bend	78	SAE Flange
1JFLH9C	JIC Male x SAE Cd 62 Flange 90 Elbow	78	SAE Flange
1JG	JIC Male x BSPP Male	10	Straight MxM
1JG*R	JIC Male x BSPP Male	11	Straight MxM
1JG4	JIC Male x JIC Male 45 Elbow	64	45 Degree
1JG6	JIC Male x BSPP Male 67 Degree Elbow	73	67 Degree
1JG9	JIC Male x BSPP Male 90 Elbow	79	90 Degree
1JG9L	JIC Male x BSPP Male 90 Elbow Long	79	90 Degree
1JI	JIC Male x BSP Banjo	12	Straight MxM
1JM	JIC Male x Metric Stud Male	12	Straight MxM
1JM9	JIC Male x Metric Male 90 Elbow	80	90 Degree
1JN	JIC Male x NPT Male	13	Straight MxM
1JN4	JIC Male x NPT Male 45 Elbow	65	45 Degree
1JN9	JIC Male x NPT Male 90 Elbow	80	90 Degree
1JO	JIC Male x UNO Male	14	Straight MxM

AYRTEC Item No	Short Description	Catalogue Page No	Visual Index Section
1JO4	JIC Male x UNO Male 45 Elbow	66	45 Degree
1JO9	JIC Male x UNO Male 90 Elbow	81	90 Degree
1JO9L	JIC Male x UNO Male 90 Extended Elbow	81	90 Degree
1JO9X	JIC Male x UNO Male Swivel 90 Elbow	82	90 Degree
1JOL	JIC Male x UNO Male Extended	15	Straight MxM
1JPI	JIC Male x SAE Inverted Flare Male	18	Straight MxM
1JT	JIC Male x BSPT Male	15	Straight MxM
1JT4	JIC Male x BSPT Male 45 Elbow	66	45 Degree
1JT9	JIC Male x BSPT Male 90 Elbow	82	90 Degree
1JT9X	JIC Male x BSPT Male Swivel 90 Elbow	83	91 Degree
1K	JIS Metric Male x JIS Metric Male (Komatsu)	16	Straight MxM
1KT	JIS Metric Male (Komatsu) x BSPT Male	16	Straight MxM
1N	NPT Male x NPT Male	16	Straight MxM
1N4	NPT Male x NPT Male 45 Elbow	67	45 Degree
1N9	NPT Male x NPT Male 90 Elbow	83	90 Degree
1NB	NPT Male x BSPP Male	17	Straight MxM
1NO	NPT Male x UNO Male	17	Straight MxM
1NO9	NPT Male x UNO Male 90 Elbow	83	90 Degree
1O	UNO Male x UNO Adjustable Male	17	Straight MxM
1O9	UNO Male x UNO Male 90 Elbow	83	90 Degree
1P	SAE 45 Deg Male x SAE 45 Deg Male	18	Straight MxM
1PPI	SAE 45 Deg Male x SAE Inverted Flare Male	18	Straight MxM
1PT	SAE 45 Deg Male x BSPT Male	18	Straight MxM
1PT4	SAE Male x BSPT Male 45 Elbow	67	45 Degree
1PT9	SAE Male x BSPT Male 90 Elbow	84	90 Degree
1S	JIS (BSP) Male x JIS (BSP) Male	19	Straight MxM
1ST	JIS (BSP) Male x BSPT Male	19	Straight MxM
1T	BSPT Male x BSPT Male	19	Straight MxM
1T4	BSPT Male x BSPT Male 45 Elbow	67	45 Degree
1T9	BSPT Male x BSPT Male 90 Elbow	84	90 Degree
1TG	BSPT Male x BSPP Male	20	Straight MxM
1TG*R	BSPT Male x BSPP Male	21	Straight MxM
1TG4	BSPT Male x BSPP Male 45 Elbow	67	45 Degree
1TG9	BSPT Male x BSPP Male 90 Elbow	84	90 Degree
1TM	BSPT Male x Metric Male	21	Straight MxM
1TN	BSPT Male x NPT Male	22	Straight MxM
1TO	BSPT Male x UNO Male	22	Straight MxM
1TO4	BSPT Male x UNO Male 45 Elbow	68	45 Degree
1TO9	BSPT Male x UNO Male 90 Elbow	85	90 Degree
2C	DKL Male x DKOL Female	134	Straight MxFS
2C9	DKL Male x DKOL Female 90 Elbow	135	90 Degree
2D	DKS Male x DKOS Female	135	Straight MxFS
2D9	DKS Male x DKOS Female 90 Elbow	136	90 Degree

AYRTEC Item No	Short Description	Catalogue Page No	Visual Index Section
2F	ORFS Male x ORFS Female Union	24	Straight MxFS
2F1	ORFS Female x ORFS Male Expander (One Piece)	24	Straight MxFS
2F2	ORFS Female x ORFS Male Reducer (Nut + Insert)	24	Straight MxFS
2F200	ORFS Tube Nut	24	Straight MxFS
2F4	ORFS Male x ORFS Female 45 Elbow	68	45 Degree
2F9	ORFS Male x ORFS Female 90 Elbow	85	90 Degree
2FJ	ORFS Male x JIC Female Union	25	Straight MxFS
2GB	BSPP Male x BSP Female Swivel Union	25	Straight MxFS
2GB*R	BSPP Male x BSP Female Swivel Union	26	Straight MxFS
2GB4	BSPP Male x BSP Female Elbow	68	45 Degree
2GB9	BSPP Male x BSPP Female 90 Elbow	85	90 Degree
2GB*GSP	BSPP Male Pressure Gauge Adaptor	106	Gauge/Test
2GC	BSPP Male (ES) x DKOL Female	136	Straight MxFS
2GD	BSPP Male (ES) x DKOS Female	136	Straight MxFS
2GF	BSPP Male x ORFS Female Swivel Union	26	Straight MxFS
2GF*R	BSPP Male x ORFS Female Swivel Union	26	Straight MxFS
2GJ	BSPP Male x JIC Female Swivel Union	27	Straight MxFS
2GJ*R	BSPP Male x JIC Female Swivel Union	27	Straight MxFS
2J	JIC Male x JIC Female	30	Straight MxFS
2J1	JIC Female x JIC Male Expander/Reducer One Piece	29	Straight MxFS
2J2	JIC Female x JIC Male Expander/Reducer Nut+Insert	30	Straight MxFS
2J200	2JTNS-0704	31	Straight MxFS
2J300	2JTNS-0805	31	Straight MxFS
2J4	JIC Male x JIC Female 45 Elbow	68	45 Degree
2J4-T	JIC Male x JIC Female 45 Swept Bend	68	45 Degree
2J9	JIC Male x JIC Female 90 Elbow	86	90 Degree
2J9-T	JIC Male x JIC Female 90 Swept Bend	86	90 Degree
2J9-TL	JIC Male x JIC Female 90 Swept Bend Long	86	90 Degree
2JB	JIC Male x BSP Female Union	31	Straight MxFS
2JB*GSP	JIC Male Pressure Gauge Adaptor	106	Gauge/Test
2JB9	JIC Male x BSP Female 90 Elbow	87	90 Degree
2JF	JIC Male x ORFS Female Union	32	Straight MxFS
2JTNS	JIC Tube Nut and Sleeve	31	Straight MxFS
2MC	Metric Male (ES) x DKOL Female	137	Straight MxFS
2NB*GSP	NPT Male Pressure Gauge Adaptor	106	Gauge/Test
2NJ	NPT Male x JIC Female	32	Straight MxFS
2NJ9	NPT Male x JIC Female 90 Elbow	87	90 Degree
2NU	NPT Male x NPSM Female	33	Straight MxFS
2NU4	NPT Male x NPSM Female 45 Elbow	69	90 Degree45 d
2NU9	NPT Male x NPSM Female 90 Elbow	87	90 Degree
2OB	UNO Male x BSPP Female	33	Straight MxFS
2OB9	UNO Male x BSP Female 90 Elbow	88	90 Degree
2OF	UNO Male x ORFS Female	33	Straight MxFS

AYRTEC Item No	Short Description	Catalogue Page No	Visual Index Section
20F9	UNO Male x ORFS Female 90 Elbow	88	90 Degree
20J	UNO Male x JIC Female	34	Straight MxFS
20J4	UNO Male x JIC Female 45 Elbow	69	45 Degree
20J9	UNO Male x JIC Female 90 Elbow	88	90 Degree
20U	UNO Male x NPSM Female	34	Straight MxFS
20U4	UNO Male x NPSM Female 45 Elbow	69	45 Degree
20U9	UNO Male x NPSM Female 90 Elbow	88	90 Degree
2P4	SAE Male xSAE Female 45 Elbow	69	45 Degree
2P9	SAE Male x SAE Female 90 Elbow	89	90 Degree
2TB	BSPT Male x BSPP Female	35	Straight MxFS
2TB4	BSPT Male x BSPP Female 45 Elbow	70	90 Degree
2TB9	BSPT Male x BSPP Female 90 Elbow	89	90 Degree
2TB9-T	BSPT Male x BSPP Female 90 Swept Elbow	89	90 Degree
2TB*GSP	BSPT Male Pressure Gauge Adaptor	106	Gauge/Test
2TF	BSPT Male x ORFS Female	35	Straight MxFS
2TJ	BSPT Male x JIC Female	36	Straight MxFS
2TJ9	BSPT Male x JIC Female 90 Elbow	89	90 Degree
2TKW	BSPT Male x Karcher Female	36	Straight MxFS
3B	BSP Female Union	37	Straight FSxFS
3C	DKOL Female x DKOL Female	137	Straight FSxFS
3D	DKOS Female x DKOS Female	138	Straight FSxFS
3F	ORFS Female Union	37	Straight FSxFS
3J	JIC Female Union	37	Straight FSxFS
3J9	JIC Female x JIC Female 90 Elbow	90	90 Degree
4C	DKL Male Plug	138	Plugs
4D	DKS Male Plug	138	Plugs
4F	ORFS Plug	48	Plugs
4FL	SAE Flange Plug CD61	48	Plugs
4FLH	SAE Flange Plug CD62	48	Plugs
4FLHC	SAE Flange Plug CAT	48	Plugs
4FW	ORFS Male Tube Weld	59	Tube Weld
4G	BSPP Plug	49	Plugs
4G-N	BSPP Socket Head Plug	49	Plugs
4GR	BSPP Reducing Bush	56	Reducing Bush
4GW	BSPP Male Tube Weld	59	Tube Weld
4J	JIC Plug	50	Plugs
4JW	JIC Male Tube Weld	59	Tube Weld
4JW9	JIC Male 90 Degree Tube Weld	60	Tube Weld
4K	JIS Metric (Komatsu) Plug	50	Plugs
4M	Metric Plug	51	Plugs
4M*ES	Metric Encapsulated Seal Plug	50	Plugs
4M-N	Metric Socket Head Plug	51	Plugs
4M-N *O	Metric Socket Head Plug O-ring Type	51	Plugs

AYRTEC Item No	Short Description	Catalogue Page No	Visual Index Section
4N	NPT Plug	52	Plugs
4N-N	NPT Socket Head Plug	52	Plugs
4NR	NPT Reducing Bush	57	Reducing Bush
4O	UNO Plug	52	Plugs
4O-N	UNO Socket Head Plug	52	Plugs
4OR	UNO Reducing Bush	57	Reducing Bush
4OTR	UNO to BSPT Reducing Bush	58	Reducing Bush
4P	SAE 45 Degree Plug	53	Plugs
4Q	Metric 37 Degree Plug	53	Plugs
4S	JIS (BSP) Plug	53	Plugs
4T	BSPT Plug	53	Plugs
4T-N	BSPT Socket Head Plug	54	Plugs
4TR	BSPT Reducing Bush	58	Reducing Bush
4TW	BSPT Male Tube Weld	60	Tube Weld
5CB	DKL Male BSPP Fixed Female	138	Straight MxFF
5DB	DKS Male BSPP Fixed Female	139	Straight MxFF
5G	BSPP Male x BSPP Fixed Female	41	Straight MxFF
5JN	JIC Male x NPT Fixed Female	41	Straight MxFF
5JN9	JIC Male x NPT Female 90 Elbow	90	90 Degree
5JT	JIC Male x BSPT Fixed Female	41	Straight MxFF
5JT9	JIC Male x BSPT Female 90 Elbow	90	90 Degree
5N	NPT Male x NPT Fixed Female	42	Straight MxFF
5N4	NPT Male x NPT Female 45 Elbow	71	45 Degree
5N9	NPT Male x NPT Female 90 Elbow	90	90 Degree
5NO	NPT Male x UNO Female	42	Straight MxFF
5O	UNO Male x UNO Female	43	Straight MxFF
5O9	UNO Male x UNO Female 90 Elbow	91	90 Degree
5ON	UNO Male x NPT Female	43	Straight MxFF
5ON9	UNO Male x NPT Female 90 Elbow	91	90 Degree
5OT	UNO Male x BSPT Female	43	Straight MxFF
5T	BST Male x BSPT Female	44	Straight MxFF
5T4	BSPT Male x BSPT Female 45 Elbow	71	45 Degree
5T9	BSPT Male x BSPT Female 90 Elbow	91	90 Degree
5TN	NPT Male x NPT Female	44	Straight MxFF
5TO	BSPT Male x UNO Female	44	Straight MxFF
6C	DKL Male x DKL Male Bulkhead	139	Straight Bulkhead
6C9	DKL Male x DKL Male Bulkhead 90 Elbow	140	90 Degree
6D	DKS Male x DKS Male Bulkhead	139	Straight Bulkhead
6D9	DKS Male x DKS Male Bulkhead 90 Elbow	140	90 Degree
6F	ORFS Male Bulkhead x ORFS Male	45	Sraight Bulkhead
6F4	ORFS Male x ORFS Male 45 Bulkhead	71	45 Degree
6F9	ORFS Bulkhead Male x ORFS Male 90 Elbow	91	90 Degree
6FG	ORFS Male Bulkhead x BSPP Male	45	Straight Bulkhead

AYRTEC Item No	Short Description	Catalogue Page No	Visual Index Section
6FO	ORFS Male Bulkhead x UNO Male	45	Straight Bulkhead
6G	BSPP Male Bulkhead x BSPP Male	45	Sraight Bulkhead
6J	JIC Male Bulkhead x JIC Male	46	Straight Bulkhead
6J4	JIC Male x JIC Male 45 Bulkhead	71	45 Degree
6J9	JIC Male Bulkhead x JIC Male 90 Elbow	92	90 Degree
6JG	JIC Male Bulkhead x BSPP Male	46	Straight Bulkhead
6JN	JIC Male Bulkhead x NPT Male	46	Straight Bulkhead
6JNF	JIC Male Bulkhead x NPT Female	46	Straight Bulkhead
6JT	JIC Male Bulkhead x BSPT Male	47	Straight Bulkhead
6JTF	JIC Male Bulkhead x BSPT Female	47	Straight Bulkhead
7B	BSPP Socket	38	Straight FxF
7N	NPT Socket	38	Straight FxF
7N4	NPT Male x NPT Female 45 Elbow	72	45 Degree
7N9	NPT Female x NPT Female 90 Elbow	92	90 Degree
7NJ	NPT Fixed Female x JIC Female	38	Straight FxF
7NU	NPT Fixed x NPSM Female	39	Straight FxF
7O	UNO Socket	39	Straight FxF
7OW	UNO Half Socket Weld On	60	Tube Weld
7T	BSPT Socket	40	Straight FxF
7T4	BSPT Female x BSPT Female 45 Elbow	72	45 Degree
7T9	BSPT Female x BSPT Female 90 Elbow	92	90 Degree
7TB	BSPT Fixed Female x BSP Swivel Female	40	Straight FxF
8F	ORFS Bulkhead Nut	105	Nut
8G	BSPP Bulkhead Nut	105	Nut
8J	JIC Bulkhead Nut	105	Nut
9B	BSP Cap	54	Caps
9BW	BSPP Female Tube Weld	61	Tube Weld
9C	DKOL Cap	141	Caps
9D	DKOS Cap	141	Caps
9F	ORFS Cap	54	Caps
9FW	ORFS Female Tube Weld (Set)	61	Tube Weld
9J*CAP	JIC Cap	54	Caps
9JW	JIC Female Tube Weld	61	Tube Weld
9K	JIS Metric (Komatsu) Cap	55	Caps
9N	NPT Cap	55	Caps
9P	SAE 45 Degree Cap	55	Caps
9S	JIS (BSP) Cap	55	Caps
A1C	DKL Male Tee	142	Tee
A1D	DKS Male Tee	142	Tee
A1F	ORFS Male Tee	93	Tee
A1F6F	ORFS Male x Bulkhead Run Tee	93	Tee
A1FF6	ORFS Male x Bulkhead Branch Tee	93	Tee
A1FFG	ORFS Male x BSPP Male Branch Tee	93	Tee

AYRTEC Item No	Short Description	Catalogue Page No	Visual Index Section
A1FFO	ORFS Male Tee x UNO Male Branch Tee	94	Tee
A1FGF	ORFS Male x BSPP Male Run Tee	94	Tee
A1FOF	ORFS Male x UNO Male Run Tee	94	Tee
A1J	JIC Male Tee	94	Tee
A1J6J	JIC Male x Bulkhead Run Tee	95	Tee
A1JGJ	JIC Male x BSPP Male Run Tee	95	Tee
A1JJ6	JIC Male x Bulkhead Branch Tee	95	Tee
A1JJG	JIC Male x BSPP Male Branch Tee	96	Tee
A1JJN	JIC Male x NPT Male Branch Tee	96	Tee
A1JJO	JIC Male x UNO Male Branch Tee	96	Tee
A1JJT	JIC Male x BSPT Male Branch Tee	97	Tee
A1JNJ	JIC Male x NPT Male Run Tee	97	Tee
A1JOJ	JIC Male x UNO Male Run Tee	97	Tee
A1JTJ	JIC Male x BSPT Male Run Tee	98	Tee
A1N	NPT Male Tee	98	Tee
A1T	BSPT Male Tee	98	Tee
A1TGT	BSPT Male x BSPP Male Run Tee	98	Tee
A1TTG	BSPT Male x BSPP Male Branch Tee	98	Tee
A2B	BSPP Male x BSPP Female Branch Tee	99	Tee
A2C	DKL Male Male Female (Drop) Tee	143	Tee
A2D	DKS Male Male Female (Drop) Tee	143	Tee
A2F	ORFS Male x ORFS Female Branch Tee	99	Tee
A2J	JIC Male x JIC Female Branch Tee	99	Tee
A2J2	JIC Female x JIC Female x JIC Male Tee	99	Tee
A2T	BSPT Male x BSPP Female Branch Tee	100	Tee
A3B	BSPP Male x BSPP Female Run Tee	100	Tee
A3C	DKL Male Male Female (Run) Tee	143	Tee
A3D	DKS Male Male Female (Run) Tee	143	Tee
A3F	ORFS Male x ORFS Female Run Tee	100	Tee
A3J	JIC Male x JIC Female Run Tee	100	Tee
A3T	BSPT Male x BSPP Female Run Tee	100	Tee
A3TB	BSPP Female x BSPT Male Branch Tee	101	Tee
A4B	BSPP Female Three Way Tee	101	Tee
A4J	JIC Female Three Way Tee	101	Tee
A4U	NPSM Female Three Way Tee	102	Tee
A5JJT	JIC Male x BSPT Female Branch Tee	102	Tee
A5N	NPT Female x NPT Male Run Tee	102	Tee
A5O	UNO Female x UNO Male Run Tee	102	Tee
A5T	BSPT Female x BSPT Male Run Tee	103	Tee
A7B	BSPP Female Tee	103	Tee
A7N	NPT Female Tee	103	Tee
A7T	BSPT Female Tee	103	Tee
A9BG	BSPT (BSPP Port) Test Point Adaptor	107	Gauge/Test

AYRTEC Item No	Short Description	Catalogue Page No	Visual Index Section
A9BT	BSPT (BSPT Port) Test Point Adaptor	107	Gauge/Test
A9CG	DKL (BSPP Port) Test Point Adaptor	107	Gauge/Test
A9FG	ORFS (BSPP Port) Test Point Adaptor	108	Gauge/Test
A9FO	ORFS (UNO Port) Test Point Adaptor	108	Gauge/Test
A9FT	ORFS (BSPT Port) Test Point Adaptor	108	Gauge/Test
A9GG	BSPP (BSPP Port) Test Point Adaptor	108	Gauge/Test
A9JG	JIC (BSPP Port) Test Point Adaptor	108	Gauge/Test
A9JO	JIC (UNO Port) Test Point Adaptor	109	Gauge/Test
A9JT	JIC (BSPT Port) Test Point Adaptor	109	Gauge/Test
BBB	Banjo Bolt BSP	118	Bolts Nuts
BBM	Banjo Bolt Metric	118	Bolts Nuts
CW	CAT Washer	110	SAE Flange
FSA	SAE Flange Solid Code 61	110	SAE Flange
FAH	SAE Flange Solid Code 62	110	SAE Flange
FSBB	SAE Blind Flange CD61	112	SAE Flange
FSBBH	SAE Blind Flange CD62	112	SAE Flange
FSC	SAE Flange CD 61 Split Clamp	110	SAE Flange
FSCH	SAE Flange CD 62 Split Clamp	111	SAE Flange
FSCHC	SAE Flange CD 62 CAT Split Clamp	111	SAE Flange
FSG	SAE Flange CD 61 x BSPP Female	113	SAE Flange
FSG9C	SAE Flange CD 61 x BSPP Female 90 Elbow	114	SAE Flange
FSGH	SAE Flange CD 62 x BSPP Female	113	SAE Flange
FSGH9C	SAE Flange CD 62 x BSPP Female 90 Elbow	114	SAE Flange
FSK	SAE Flange CD 61 Split Clamp Kit	111	SAE Flange
FSKH	SAE Flange CD 62 Split Clamp Kit	112	SAE Flange
GE	DKLL Male x METRIC Tapered Male	141	Straight MxM
NL / NS	Metric Compression Nut	119	Straight MxFS
OR-BPA	BSPP Retaining Ring + O-Ring	115	O-Ring
OR-BRR	OR-BPA-02	115	O-Ring
OR-BSP	OR-BPA-04	115	O-Ring
OR-DKO	METRIC DKO L/S O-Ring	115	O-Ring
OR-F	ORFS O-Ring	115	O-Ring
OR-FL	SAE Flange O-Ring	115	O-Ring
OR-G	Encapsulated Seal	116	O-Ring
OR-GBC	Bonded Seal (Self Centering)	116	O-Ring
OR-GBS	BSPP Bonded Seal	116	O-Ring
OR-GSP	Pressure Gauge Adaptor O-Ring	117	O-Ring
OR-MBS	Metric Bonded Seal	117	O-Ring
OR-O	UNO O-Ring	117	O-Ring
RL / RS	Metric Cutting Ring	120	Straight MxFS
TP	Test Point	109	Gauge/Test
WE	DKLL Male x METRIC Tapered Male 90 Elbow	142	90 Degree
ZJ	JIC Male Cross	104	Cross
ZN	NPT Female Cross	104	Cross



ADAPTORS

AYRTEC Item No	Short Description	Catalogue Page No	Visual Index Section
ZT	BSPT Female Cross	104	Cross



Contact us in Australia:

sales@ayrtecfittings.com

Phone 0401 290 546

Contact us in China:

sales@ayrtecfittings.com

Phone +86 186 4118 0302